

HMX series

end mills for high-hardness steel machining

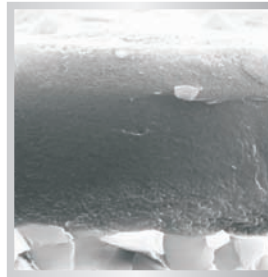

Lattice heterogeneous coating

Lattice heterogeneous coating added with special elements, with high hardness and excellent high temperature oxidation resistance, more suitable for high hardness materials and high speed machining

Excellent coating processing technology, more closely combined with substrate

New technology
Breakthrough upgrading

- unique edge structure, properly designed chipbreaker, for outstanding cutting performance.
- Orange red coating allows for better wear observation.
- Special after treatment greatly reduces friction, for smoother chip evacuation and superior surface quality.

Perfect high temperature oxidation resistance:

After oxidation at 1100 °C, the coating of HMX series only has a very thin oxide layer, while the similar products of Company A has completely oxidized.

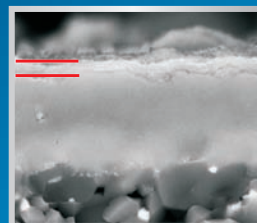

HMX series

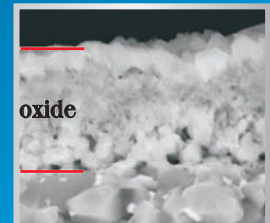

A company

HMX series for machining high hardness steel

2-flute flattened end mills with straight shank



HMX-2E

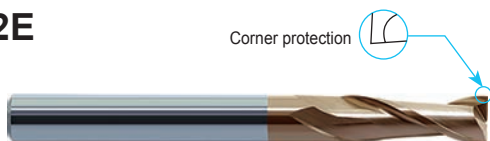

Corner protection

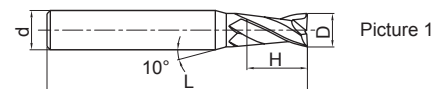

Picture 1

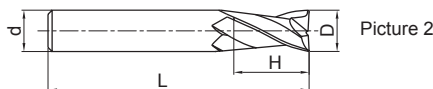

Picture 2

- For slot milling.
- Very suitable for high speed cutting and dry cutting.

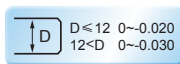
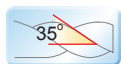

Type	Basic dimension(mm)				Number of teeth Z	Geometry	Stock
	D	d	H	L			
HMX-2E-D1.0F	1.0	3	3	50	2	Picture 1	●
HMX-2E-D1.0S	1.0	4	3	50	2	Picture 1	●
HMX-2E-D1.0	1.0	6	3	50	2	Picture 1	●
HMX-2E-D1.5S	1.5	4	4	50	2	Picture 1	●
HMX-2E-D1.5	1.5	6	4	50	2	Picture 1	●
HMX-2E-D2.0F	2.0	3	6	50	2	Picture 1	●
HMX-2E-D2.0S	2.0	4	6	50	2	Picture 1	●
HMX-2E-D2.0	2.0	6	6	50	2	Picture 1	●
HMX-2E-D2.5S	2.5	4	8	50	2	Picture 1	●
HMX-2E-D2.5	2.5	6	8	50	2	Picture 1	●
HMX-2E-D3.0F	3.0	3	8	50	2	Picture 2	●
HMX-2E-D3.0S	3.0	4	8	50	2	Picture 1	●
HMX-2E-D3.0	3.0	6	8	50	2	Picture 1	●
HMX-2E-D3.5S	3.5	4	10	50	2	Picture 1	●
HMX-2E-D3.5	3.5	6	10	50	2	Picture 1	●
HMX-2E-D4.0S	4.0	4	11	50	2	Picture 2	●

● Stock available ○ Make-to-order

Indexable milling tools

Solid carbide end mills

HMX series

Applicable workpiece material table ● Very suitable ○ Suitable

Workpiece material											
Carbon steel	Alloy steel	Pre-hardened steel, Hardened steel				Stainless steel	Cast iron, Nodular cast iron	Copper alloy	Aluminum alloy	Titanium alloy	Heat resistant alloy
		~40HRC	~50HRC	~55HRC	~68HRC						
			○	●	●		○				

Code key

B258

Graphics category and identification

B259

Cutting parameters

B524

Non-standard customization

B570-B571

HMX series for machining high hardness steel

2-flute flattened end mills with straight shank



HMX-2E

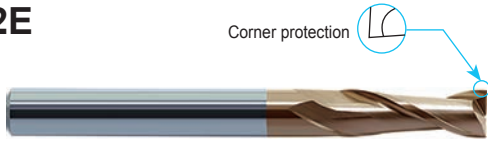

- For slot milling.
- Very suitable for high speed cutting and dry cutting.

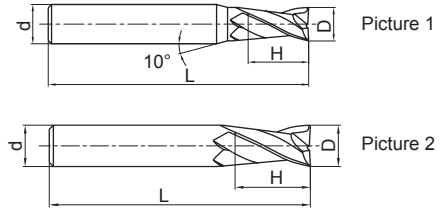
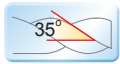

Type	Basic dimension(mm)				Number of teeth Z	Geometry	Stock
	D	d	H	L			
HMX-2E-D4.0	4.0	6	11	50	2	Picture 1	●
HMX-2E-D4.5	4.5	6	11	50	2	Picture 1	●
HMX-2E-D5.0	5.0	6	13	50	2	Picture 1	●
HMX-2E-D5.5	5.5	6	16	50	2	Picture 1	●
HMX-2E-D6.0	6.0	6	16	50	2	Picture 2	●
HMX-2E-D7.0	7.0	8	20	60	2	Picture 1	●
HMX-2E-D8.0	8.0	8	20	60	2	Picture 2	●
HMX-2E-D9.0	9.0	10	22	75	2	Picture 1	●
HMX-2E-D10.0	10.0	10	25	75	2	Picture 2	●
HMX-2E-D11.0	11.0	12	26	75	2	Picture 1	●
HMX-2E-D12.0	12.0	12	30	75	2	Picture 2	●
HMX-2E-D14.0	14.0	14	32	100	2	Picture 2	●
HMX-2E-D16.0	16.0	16	45	100	2	Picture 2	●
HMX-2E-D18.0	18.0	18	45	100	2	Picture 2	●
HMX-2E-D20.0	20.0	20	45	100	2	Picture 2	●

● Stock available ○ Make-to-order

Indexable milling tools
Solid carbide end mills
HMX series

➤ Applicable workpiece material table ● Very suitable ○ Suitable

Workpiece material											
Carbon steel	Alloy steel	Pre-hardened steel, Hardened steel				Stainless steel	Cast iron, Nodular cast iron	Copper alloy	Aluminum alloy	Titanium alloy	Heat resistant alloy
		~40HRC	~50HRC	~55HRC	~68HRC						
			○	●	●		○				



HMX series for machining high hardness steel

2-flute flattened end mills with long straight shank and short cutting edge



HMX-2EFP

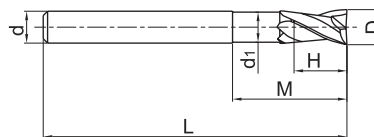
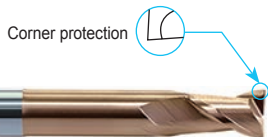

● High-rigidity short cutting edge, suitable for heavy cutting and deep cavity milling.

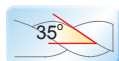

Type	Basic dimension(mm)						Number of teeth Z	Stock
	D	d	H	M	d1	L		
HMX-2EFP-D6.0	6.0	6	9	30	5.8	75	2	●
HMX-2EFP-D8.0	8.0	8	12	40	7.8	100	2	●
HMX-2EFP-D10.0	10.0	10	15	50	9.6	100	2	●
HMX-2EFP-D12.0	12.0	12	18	50	11.5	100	2	●
HMX-2EFP-D16.0	16.0	16	24	50	15.5	150	2	●
HMX-2EFP-D20.0	20.0	20	30	60	19.5	150	2	●

● Stock available ○ Make-to-order

Indexable milling tools

Solid carbide end mills

HMX series

Applicable workpiece material table ○ Very suitable ○ Suitable

Workpiece material											
Carbon steel	Alloy steel	Pre-hardened steel, Hardened steel				Stainless steel	Cast iron, Nodular cast iron	Copper alloy	Aluminum alloy	Titanium alloy	Heat resistant alloy
		~40HRC	~50HRC	~55HRC	~68HRC						
			○	○	○		○				

Code key

B258

Graphics category and identification

B259

Cutting parameters

B525

Non-standard customization

B570-B571

HMX series for machining high hardness steel

2-flute flattened end mills with straight shank



HMX-2EBL/X

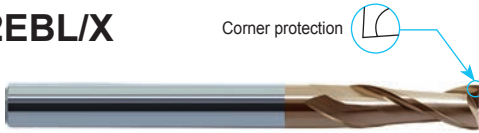

Corner protection

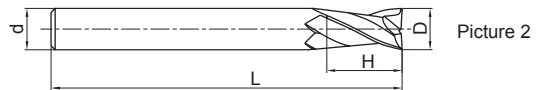
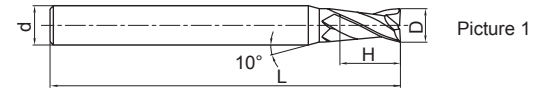

● HMX-2E series with long shank.

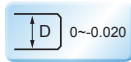
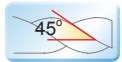

Type	Basic dimension(mm)				Number of teeth Z	Geometry	Stock
	D	d	H	L			
HMX-2EBL-D3.0	3.0	6	8	75	2	Picture 1	○
HMX-2EBL-D4.0S	4.0	4	11	75	2	Picture 2	○
HMX-2EBL-D4.0	4.0	6	11	75	2	Picture 1	○
HMX-2EBL-D6.0	6.0	6	16	75	2	Picture 2	○
HMX-2EBX-D6.0	6.0	6	16	100	2	Picture 2	○
HMX-2EBL-D8.0	8.0	8	20	75	2	Picture 2	○
HMX-2EBX-D8.0	8.0	8	20	100	2	Picture 2	○
HMX-2EBL-D10.0	10.0	10	25	100	2	Picture 2	○
HMX-2EBX-D10.0	10.0	10	25	150	2	Picture 2	○
HMX-2EBL-D12.0	12.0	12	30	100	2	Picture 2	○
HMX-2EBX-D12.0	12.0	12	30	150	2	Picture 2	○

● Stock available ○ Make-to-order

Indexable milling tools

Solid carbide end mills

HMX series

➤ Applicable workpiece material table ● Very suitable ○ Suitable

Workpiece material											
Carbon steel	Alloy steel	Pre-hardened steel, Hardened steel				Stainless steel	Cast iron, Nodular cast iron	Copper alloy	Aluminum alloy	Titanium alloy	Heat resistant alloy
		~40HRC	~50HRC	~55HRC	~68HRC						
			○	●	●		○				



HMX series for machining high hardness steel

4-flute flattened end mills with straight shank



HMX-4E

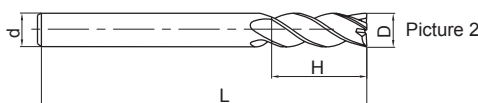
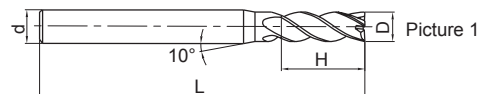

- For side milling and shallow slot milling.
- Very suitable for high speed cutting and dry cutting.

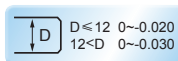
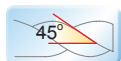

Type	Basic dimension(mm)				Number of teeth Z	Geometry	Stock
	D	d	H	L			
HMX-4E-D1.0F	1.0	3	3	50	4	Picture 1	●
HMX-4E-D1.0S	1.0	4	3	50	4	Picture 1	●
HMX-4E-D1.0	1.0	6	3	50	4	Picture 1	●
HMX-4E-D1.5F	1.5	3	4	50	4	Picture 1	●
HMX-4E-D1.5S	1.5	4	4	50	4	Picture 1	●
HMX-4E-D1.5	1.5	6	4	50	4	Picture 1	●
HMX-4E-D2.0F	2.0	3	6	50	4	Picture 1	●
HMX-4E-D2.0S	2.0	4	6	50	4	Picture 1	●
HMX-4E-D2.0	2.0	6	6	50	4	Picture 1	●
HMX-4E-D2.5F	2.5	3	8	50	4	Picture 1	●
HMX-4E-D2.5S	2.5	4	8	50	4	Picture 1	●
HMX-4E-D2.5	2.5	6	8	50	4	Picture 1	●
HMX-4E-D3.0F	3.0	3	8	50	4	Picture 2	●
HMX-4E-D3.0S	3.0	4	8	50	4	Picture 1	●
HMX-4E-D3.0	3.0	6	8	50	4	Picture 1	●
HMX-4E-D3.5S	3.5	4	10	50	4	Picture 1	●
HMX-4E-D4.0S	4.0	4	11	50	4	Picture 2	●

● Stock available ○ Make-to-order

Indexable milling tools

Solid carbide end mills

HMX series

Applicable workpiece material table ● Very suitable ○ Suitable

Workpiece material											
Carbon steel	Alloy steel	Pre-hardened steel, Hardened steel				Stainless steel	Cast iron, Nodular cast iron	Copper alloy	Aluminum alloy	Titanium alloy	Heat resistant alloy
		~40HRC	~50HRC	~55HRC	~68HRC						
			○	●	●		○				

Code key

B258

Graphics category and identification

B259

Cutting parameters

B526

Non-standard customization

B570-B571

HMX series for machining high hardness steel

4-flute flattened end mills with straight shank



HMX-4E

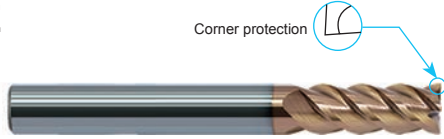

- For side milling and shallow slot milling.
- Very suitable for high speed cutting and dry cutting.

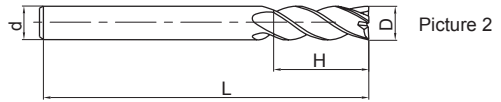
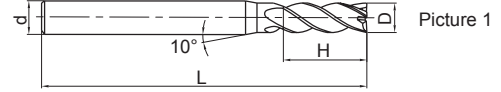

Type	Basic dimension(mm)				Number of teeth Z	Geometry	Stock
	D	d	H	L			
HMX-4E-D3.5	3.5	6	10	50	4	Picture 1	●
HMX-4E-D4.0	4.0	6	11	50	4	Picture 1	●
HMX-4E-D4.5	4.5	6	11	50	4	Picture 1	●
HMX-4E-D5.0	5.0	6	13	50	4	Picture 1	●
HMX-4E-D5.5	5.5	6	16	50	4	Picture 1	●
HMX-4E-D6.0	6.0	6	16	50	4	Picture 2	●
HMX-4E-D7.0	7.0	8	20	60	4	Picture 1	●
HMX-4E-D8.0	8.0	8	20	60	4	Picture 2	●
HMX-4E-D9.0	9.0	10	22	75	4	Picture 1	●
HMX-4E-D10.0	10.0	10	25	75	4	Picture 2	●
HMX-4E-D11.0	11.0	12	26	75	4	Picture 1	●
HMX-4E-D12.0	12.0	12	30	75	4	Picture 2	●
HMX-4E-D14.0	14.0	14	32	75	4	Picture 2	●
HMX-4E-D16.0	16.0	16	45	100	4	Picture 2	●
HMX-4E-D18.0	18.0	18	45	100	4	Picture 2	●
HMX-4E-D20.0	20.0	20	45	100	4	Picture 2	●

● Stock available ○ Make-to-order

Indexable milling tools
Solid carbide end mills
HMX series

➤ Applicable workpiece material table ● Very suitable ○ Suitable

Workpiece material											
Carbon steel	Alloy steel	Pre-hardened steel, Hardened steel				Stainless steel	Cast iron, Nodular cast iron	Copper alloy	Aluminum alloy	Titanium alloy	Heat resistant alloy
		~40HRC	~50HRC	~55HRC	~68HRC						
			○	●	●		○				



HMX series for machining high hardness steel

4-flute flattened end mills with straight shank and long cutting edge



HMX-4EL

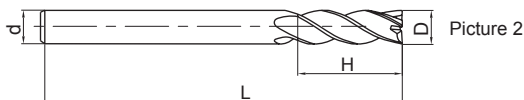
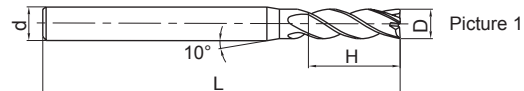
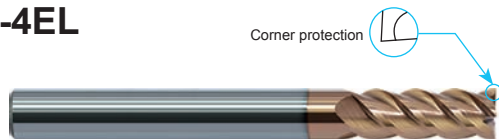

● HM-4E series with long cutting edge.

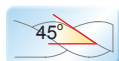

Type	Basic dimension(mm)				Number of teeth Z	Geometry	Stock
	D	d	H	L			
HMX-4EL-D3.0	3.0	6	12	75	4	Picture 1	●
HMX-4EL-D4.0	4.0	6	15	75	4	Picture 1	●
HMX-4EL-D5.0	5.0	6	20	75	4	Picture 1	●
HMX-4EL-D6.0	6.0	6	20	75	4	Picture 2	●
HMX-4EL-D8.0	8.0	8	25	100	4	Picture 2	●
HMX-4EL-D10.0	10.0	10	30	100	4	Picture 2	●
HMX-4EL-D12.0	12.0	12	35	100	4	Picture 2	●
HMX-4EL-D14.0	14.0	14	40	100	4	Picture 2	●
HMX-4EL-D16.0	16.0	16	50	150	4	Picture 2	●
HMX-4EL-D20.0	20.0	20	55				

Indexable milling tools

Solid carbide end mills

HMX series

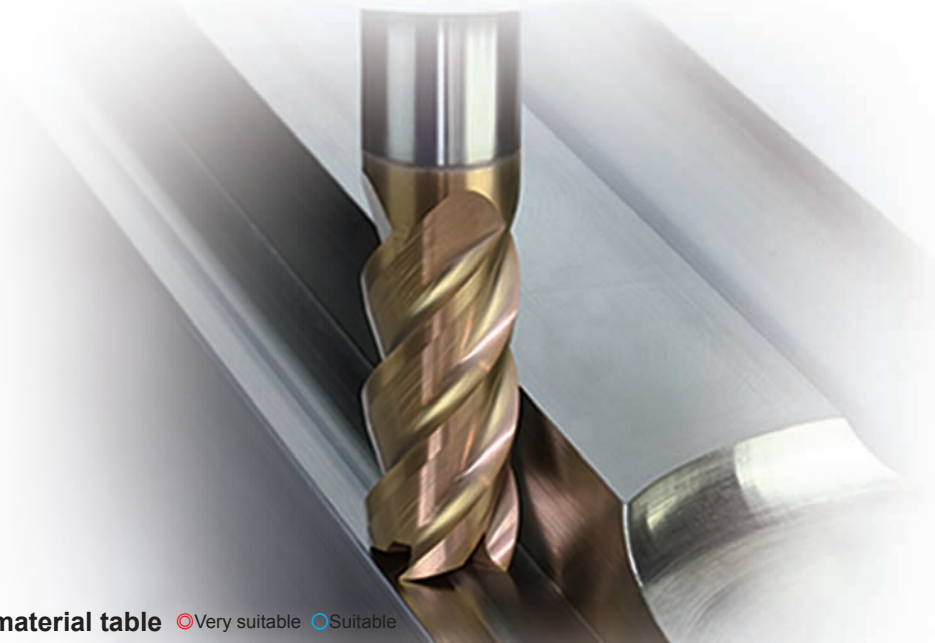

Applicable workpiece material table

Workpiece material

Carbon steel	Alloy steel	Pre-hardened steel, Hardened steel				Stainless steel	Cast iron, Nodular cast iron	Copper alloy	Aluminum alloy	Titanium alloy	Heat resistant alloy
		~40HRC	~50HRC	~55HRC	~68HRC						
			○	◎	◎		○				

Code key

B258

Graphics category and identification

B259

Cutting parameters

B526

Non-standard customization

B570-B571

HMX series for machining high hardness steel

4-flute flattened end mills with straight shank, long neck and short cutting edge



HMX-4EFP

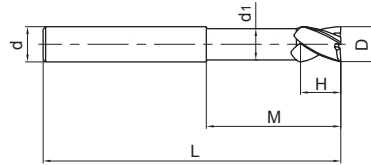
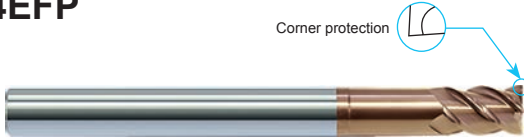

● High-rigidity short cutting edge, suitable for heavy cutting and deep cavity milling.

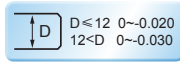
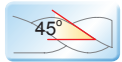

Type	Basic dimension(mm)						Number of teeth Z	Stock
	D	d	H	M	d ₁	L		
HMX-4EFP-D6.0	6.0	6	9	30	5.8	75	4	●
HMX-4EFP-D8.0	8.0	8	12	40	7.8	100	4	●
HMX-4EFP-D10.0	10.0	10	15	50	9.6	100	4	●
HMX-4EFP-D12.0	12.0	12	18	50	11.5	100	4	●
HMX-4EFP-D16.0	16.0	16	24	50	15.5	150	4	●
HMX-4EFP-D20.0	20.0	20	30	60	19.5	150	4	●

● Stock available ○ Make-to-order

Indexable milling tools
Solid carbide end mills
HMX series

➤ Applicable workpiece material table ○ Very suitable ○ Suitable

Workpiece material											
Carbon steel	Alloy steel	Pre-hardened steel, Hardened steel				Stainless steel	Cast iron, Nodular cast iron	Copper alloy	Aluminum alloy	Titanium alloy	Heat resistant alloy
		~40HRC	~50HRC	~55HRC	~68HRC						
			○	○	○		○				



HMX series for machining high hardness steel

4-flute flattened end mills with long shank



HMX-4EBL/X

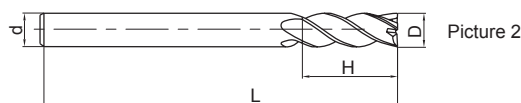
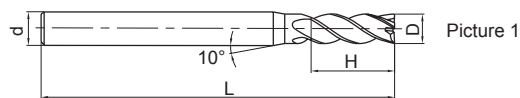
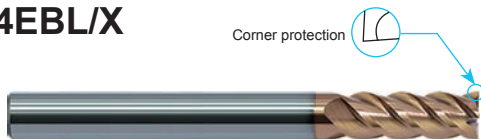

● HMX-4E series with long shank.

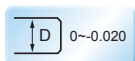
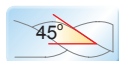

Type	Basic dimension(mm)				Number of teeth Z	Geometry	Stock
	D	d	H	L			
HMX-4EBL-D3.0S	3.0	4	8	75	4	Picture 1	●
HMX-4EBL-D3.0	3.0	6	8	75	4	Picture 1	●
HMX-4EBL-D4.0S	4.0	4	11	75	4	Picture 2	●
HMX-4EBL-D4.0	4.0	6	11	75	4	Picture 1	●
HMX-4EBL-D6.0	6.0	6	16	75	4	Picture 2	●
HMX-4EBX-D6.0	6.0	6	16	100	4	Picture 2	●
HMX-4EBL-D8.0	8.0	8	20	75	4	Picture 2	●
HMX-4EBX-D8.0	8.0	8	20	100	4	Picture 2	●
HMX-4EBL-D10.0	10.0	10	25	100	4	Picture 2	●
HMX-4EBX-D10.0	10.0	10	25	150	4	Picture 2	●
HMX-4EBL-D12.0	12.0	12	30	100	4	Picture 2	●
HMX-4EBX-D12.0	12.0	12	30	150	4	Picture 2	●

● Stock available ○ Make-to-order

Indexable milling tools

Solid carbide end mills

HMX series

Applicable workpiece material table ○ Very suitable ○ Suitable

Workpiece material											
Carbon steel	Alloy steel	Pre-hardened steel, Hardened steel				Stainless steel	Cast iron, Nodular cast iron	Copper alloy	Aluminum alloy	Titanium alloy	Heat resistant alloy
		~40HRC	~50HRC	~55HRC	~68HRC						
			○	○	○		○				

Code key

B258

Graphics category and identification

B259

Cutting parameters

B526

Non-standard customization

B570-B571

HMX series for machining high hardness steel

6-flute flattened end mills with straight shank



HMX-6E

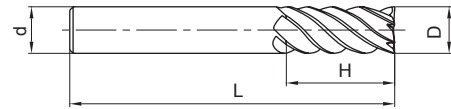
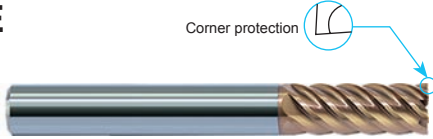

- High tool rigidity reduce tool deflection in side milling.
- Very suitable for high speed cutting and dry cutting.



Type	Basic dimension(mm)				Number of teeth Z	Stock
	D	d	H	L		
HMX-6E-D6.0	6.0	6	18	60	6	●
HMX-6E-D8.0	8.0	8	20	60	6	●
HMX-6E-D10.0	10.0	10	30	75	6	●
HMX-6E-D12.0	12.0	12	32	75	6	●
HMX-6E-D16.0	16.0	16	40	100	6	●
HMX-6E-D20.0	20.0	20	45	100	6	●

● Stock available ○ Make-to-order

Indexable milling tools
Solid carbide end mills
HMX series

➤ Applicable workpiece material table ○Very suitable ○Suitable

Workpiece material											
Carbon steel	Alloy steel	Pre-hardened steel, Hardened steel				Stainless steel	Cast iron, Nodular cast iron	Copper alloy	Aluminum alloy	Titanium alloy	Heat resistant alloy
		~40HRC	~50HRC	~55HRC	~68HRC						
			○	○	○		○				



HMX series for machining high hardness steel

6-flute flattened end mills with straight shank and long cutting edge



HMX-6EL

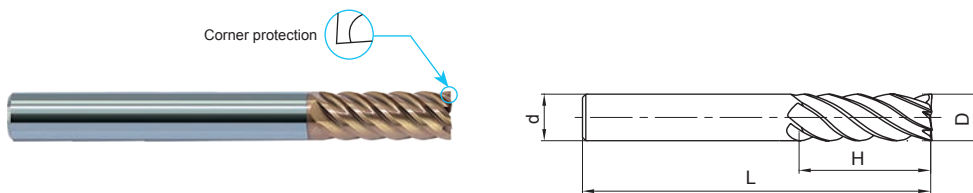

● HM-6E series with long cutting edge.



Type	Basic dimension(mm)				Number of teeth Z	Stock
	D	d	H	L		
HMX-6EL-D6.0	6.0	6	24	75	6	●
HMX-6EL-D8.0	8.0	8	32	75	6	●
HMX-6EL-D10.0	10.0	10	40	100	6	●
HMX-6EL-D12.0	12.0	12	45	100	6	●
HMX-6EL-D16.0	16.0	16	64	150	6	●
HMX-6EL-D20.0	20.0	20	75	150	6	●

● Stock available ○ Make-to-order

Indexable milling tools

Solid carbide end mills

HMX series

Applicable workpiece material table ○ Very suitable ○ Suitable

Workpiece material											
Carbon steel	Alloy steel	Pre-hardened steel, Hardened steel				Stainless steel	Cast iron, Nodular cast iron	Copper alloy	Aluminum alloy	Titanium alloy	Heat resistant alloy
		~40HRC	~50HRC	~55HRC	~68HRC						
			○	◎	◎		○				



2-flute flattened end mills with straight shank, long neck and short cutting edge



Deep flattened slot

HMX-2EP



● Suitable for narrow slot milling or milling of fine parts that could generate interference.

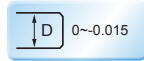
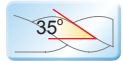
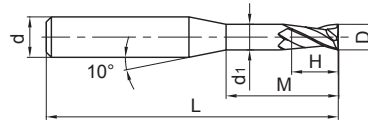

Type	Basic dimension(mm)						Number of teeth Z	Stock
	D	d	H	M	d1	L		
HMX-2EP-D0.3-M02	0.3	4	0.4	2	0.25	50	2	●
HMX-2EP-D0.3-M04	0.3	4	0.4	4	0.25	50	2	●
HMX-2EP-D0.4-M02	0.4	4	0.6	2	0.35	50	2	●
HMX-2EP-D0.4-M04	0.4	4	0.6	4	0.35	50	2	●
HMX-2EP-D0.5-M04	0.5	4	0.7	4	0.45	50	2	●
HMX-2EP-D0.5-M06	0.5	4	0.7	6	0.45	50	2	●
HMX-2EP-D0.5-M08	0.5	4	0.7	8	0.45	50	2	●
HMX-2EP-D0.6-M04	0.6	4	0.9	4	0.55	50	2	●
HMX-2EP-D0.6-M06	0.6	4	0.9	6	0.55	50	2	●
HMX-2EP-D0.7-M04	0.7	4	1.0	4	0.65	50	2	●
HMX-2EP-D0.7-M06	0.7	4	1.0	6	0.65	50	2	●
HMX-2EP-D0.7-M08	0.7	4	1.0	8	0.65	50	2	●
HMX-2EP-D0.8-M04	0.8	4	1.2	4	0.75	50	2	●
HMX-2EP-D0.8-M06	0.8	4	1.2	6	0.75	50	2	●
HMX-2EP-D0.8-M08	0.8	4	1.2	8	0.75	50	2	●
HMX-2EP-D0.8-M10	0.8	4	1.2	10	0.75	50	2	●
HMX-2EP-D1.0-M04	1.0	4	1.5	4	0.95	50	2	●
HMX-2EP-D1.0-M06	1.0	4	1.5	6	0.95	50	2	●
HMX-2EP-D1.0-M08	1.0	4	1.5	8	0.95	50	2	●
HMX-2EP-D1.0-M10	1.0	4	1.5	10	0.95	50	2	●
HMX-2EP-D1.0-M12	1.0	4	1.5	12	0.95	50	2	●
HMX-2EP-D1.0-M14	1.0	4	1.5	14	0.95	50	2	●
HMX-2EP-D1.2-M06	1.2	4	1.8	6	1.15	50	2	●
HMX-2EP-D1.2-M08	1.2	4	1.8	8	1.15	50	2	●
HMX-2EP-D1.2-M10	1.2	4	1.8	10	1.15	50	2	●
HMX-2EP-D1.2-M12	1.2	4	1.8	12	1.15	50	2	●
HMX-2EP-D1.5-M06	1.5	4	2.3	6	1.45	50	2	●
HMX-2EP-D1.5-M08	1.5	4	2.3	8	1.45	50	2	●
HMX-2EP-D1.5-M10	1.5	4	2.3	10	1.45	50	2	●

Applicable workpiece material table ● Very suitable ○ Suitable

● Stock available ○ Make-to-order

Workpiece material											
Carbon steel	Alloy steel	Pre-hardened steel, Hardened steel				Stainless steel	Cast iron, Nodular cast iron	Copper alloy	Aluminum alloy	Titanium alloy	Heat resistant alloy
		~40HRC	~50HRC	~55HRC	~68HRC						
			○	●	●		○				

Code key

B258

Graphics category and identification

B259

Cutting parameters

B530-B531

Non-standard customization

B570-B571

Indexable milling tools
Solid carbide end mills
HMX series

HMX series for machining high hardness steel

2-flute flattened end mills with straight shank, long neck and short cutting edge



Deep flattened slot

HMX-2EP



● Suitable for narrow slot milling or milling of fine parts that could generate interference.

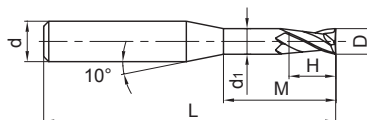
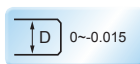
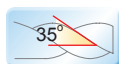

Indexable milling tools

Solid carbide end mills

HMX series

Type	Basic dimension(mm)						Number of teeth Z	Stock
	D	d	H	M	d ₁	L		
HMX-2EP-D1.5-M12	1.5	4	2.3	12	1.45	50	2	●
HMX-2EP-D1.5-M14	1.5	4	2.3	14	1.45	50	2	●
HMX-2EP-D2.0-M06	2.0	4	3.0	6	1.95	50	2	●
HMX-2EP-D2.0-M08	2.0	4	3.0	8	1.95	50	2	●
HMX-2EP-D2.0-M10	2.0	4	3.0	10	1.95	50	2	●
HMX-2EP-D2.0-M12	2.0	4	3.0	12	1.95	50	2	●
HMX-2EP-D2.0-M14	2.0	4	3.0	14	1.95	50	2	●
HMX-2EP-D2.0-M16	2.0	4	3.0	16	1.95	50	2	●
HMX-2EP-D2.5-M08	2.5	4	3.7	8	2.4	50	2	●
HMX-2EP-D2.5-M10	2.5	4	3.7	10	2.4	50	2	●
HMX-2EP-D2.5-M12	2.5	4	3.7	12	2.4	50	2	●
HMX-2EP-D2.5-M14	2.5	4	3.7	14	2.4	50	2	●
HMX-2EP-D2.5-M16	2.5	4	3.7	16	2.4	60	2	●
HMX-2EP-D2.5-M18	2.5	4	3.7	18	2.4	60	2	●
HMX-2EP-D2.5-M20	2.5	4	3.7	20	2.4	60	2	●
HMX-2EP-D3.0-M06	3.0	6	4.5	6	2.85	50	2	●
HMX-2EP-D3.0-M08	3.0	6	4.5	8	2.85	50	2	●
HMX-2EP-D3.0-M10	3.0	6	4.5	10	2.85	50	2	●
HMX-2EP-D3.0-M12	3.0	6	4.5	12	2.85	50	2	●
HMX-2EP-D3.0-M14	3.0	6	4.5	14	2.85	60	2	●
HMX-2EP-D3.0-M16	3.0	6	4.5	16	2.85	60	2	●
HMX-2EP-D3.0-M18	3.0	6	4.5	18	2.85	60	2	●
HMX-2EP-D3.0-M20	3.0	6	4.5	20	2.85	60	2	●
HMX-2EP-D4.0-M12	4.0	6	6.0	12	3.85	60	2	●
HMX-2EP-D4.0-M16	4.0	6	6.0	16	3.85	60	2	●
HMX-2EP-D4.0-M20	4.0	6	6.0	20	3.85	60	2	●
HMX-2EP-D4.0-M25	4.0	6	6.0	25	3.85	60	2	●
HMX-2EP-D5.0-M16	5.0	6	7.5	16	4.85	60	2	●
HMX-2EP-D5.0-M25	5.0	6	7.5	25	4.85	70	2	●

● Stock available ○ Make-to-order

➤ Applicable workpiece material table ● Very suitable ○ Suitable

Workpiece material											
Carbon steel	Alloy steel	Pre-hardened steel, Hardened steel				Stainless steel	Cast iron, Nodular cast iron	Copper alloy	Aluminum alloy	Titanium alloy	Heat resistant alloy
		~40HRC	~50HRC	~55HRC	~68HRC						
			○	●	●		○				

Code key

B258

Graphics category and identification

B259

Cutting parameters

B530-B531

Non-standard customization

B570-B571

HMX series for machining high hardness steel

2-flute flattened end mills with straight shank and tiny diameter



HMX-2ES



Tiny diameter end mills can fully display high speed and high precision performances of machining center, often used for machining of precision components such as electronic part etc.

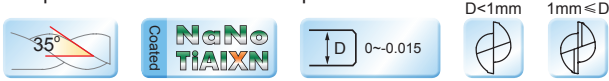
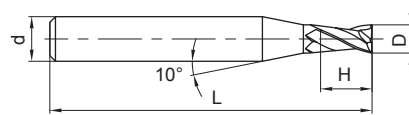

Type	Basic dimension(mm)				Number of teeth Z	Stock
	D	d	H	L		
HMX-2ES-D0.3	0.3	4	0.6	50	2	●
HMX-2ES-D0.4	0.4	4	0.8	50	2	●
HMX-2ES-D0.5	0.5	4	1.0	50	2	●
HMX-2ES-D0.6	0.6	4	1.2	50	2	●
HMX-2ES-D0.7	0.7	4	1.4	50	2	●
HMX-2ES-D0.8	0.8	4	1.6	50	2	●
HMX-2ES-D0.9	0.9	4	1.8	50	2	●
HMX-2ES-D1.0	1.0	4	2.0	50	2	●
HMX-2ES-D1.1	1.1	4	2.0	50	2	●
HMX-2ES-D1.2	1.2	4	2.5	50	2	●
HMX-2ES-D1.3	1.3	4	2.5	50	2	●
HMX-2ES-D1.4	1.4	4	3.0	50	2	●
HMX-2ES-D1.5	1.5	4	3.0	50	2	●
HMX-2ES-D1.6	1.6	4	3.5	50	2	●
HMX-2ES-D1.7	1.7	4	3.5	50	2	●
HMX-2ES-D1.8	1.8	4	4.0	50	2	●
HMX-2ES-D1.9	1.9	4	4.0	50	2	●
HMX-2ES-D2.0	2.0	4	4.0	50	2	●
HMX-2ES-D2.1	2.1	4	4.0	50	2	●
HMX-2ES-D2.2	2.2	4	4.5	50	2	●
HMX-2ES-D2.3	2.3	4	4.5	50	2	●
HMX-2ES-D2.4	2.4	4	5.0	50	2	●
HMX-2ES-D2.5	2.5	4	5.0	50	2	●
HMX-2ES-D2.6	2.6	4	5.0	50	2	●
HMX-2ES-D2.7	2.7	4	5.5	50	2	●
HMX-2ES-D2.8	2.8	4	5.5	50	2	●
HMX-2ES-D2.9	2.9	4	6.0	50	2	●
HMX-2ES-D3.0	3.0	4	6.0	50	2	●

● Stock available ○ Make-to-order

Applicable workpiece material table ○Very suitable ○Suitable

Workpiece material											
Carbon steel	Alloy steel	Pre-hardened steel, Hardened steel				Stainless steel	Cast iron, Nodular cast iron	Copper alloy	Aluminum alloy	Titanium alloy	Heat resistant alloy
		~40HRC	~50HRC	~55HRC	~68HRC						
			○	○	○		○				



Indexable milling tools
Solid carbide end mills
HMX series



MILLING Solid Carbide End Mills

HMX series for machining high hardness steel

2-flute ball nose end mills with straight shank



HMX-2B

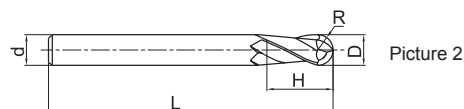
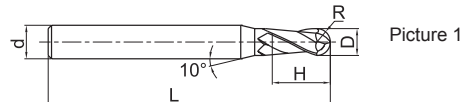

- For profile milling.
- Very suitable for high speed cutting and dry cutting.

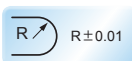

Type	Basic dimension(mm)					Number of teeth Z	Geometry	Stock
	D	R	d	H	L			
HMX-2B-R0.5S	1.0	0.5	4	2	50	2	Picture 1	●
HMX-2B-R0.5	1.0	0.5	6	2	50	2	Picture 1	●
HMX-2B-R0.75S	1.5	0.75	4	3	50	2	Picture 1	●
HMX-2B-R0.75	1.5	0.75	6	3	50	2	Picture 1	●
HMX-2B-R1.0S	2.0	1.0	4	4	50	2	Picture 1	●
HMX-2B-R1.0	2.0	1.0	6	4	50	2	Picture 1	●
HMX-2B-R1.25S	2.5	1.25	4	5	50	2	Picture 1	●
HMX-2B-R1.25	2.5	1.25	6	5	50	2	Picture 1	●
HMX-2B-R1.5S	3.0	1.5	4	6	50	2	Picture 1	●
HMX-2B-R1.5	3.0	1.5	6	6	50	2	Picture 1	●
HMX-2B-R1.75	3.5	1.75	6	8	50	2	Picture 1	●
HMX-2B-R2.0S	4.0	2.0	4	8	50	2	Picture 2	●
HMX-2B-R2.0	4.0	2.0	6	8	50	2	Picture 1	●
HMX-2B-R2.5	5.0	2.5	6	10	50	2	Picture 1	●
HMX-2B-R2.75	5.5	2.75	6	12	50	2	Picture 1	●
HMX-2B-R3.0	6.0	3.0	6	12	50	2	Picture 2	●
HMX-2B-R3.5	7.0	3.5	8	14	60	2	Picture 1	●
HMX-2B-R4.0	8.0	4.0	8	16	60	2	Picture 2	●
HMX-2B-R4.5	9.0	4.5	10	18	75	2	Picture 1	●
HMX-2B-R5.0	10.0	5.0	10	20	75	2	Picture 2	●
HMX-2B-R6.0	12.0	6.0	12	24	75	2	Picture 2	●
HMX-2B-R7.0	14.0	7.0	14	28	75	2	Picture 2	●
HMX-2B-R8.0	16.0	8.0	16	32	100	2	Picture 2	●
HMX-2B-R10.0	20.0	10.0	20	40	100	2	Picture 2	●

● Stock available ○ Make-to-order

Workpiece material											
Carbon steel	Alloy steel	Pre-hardened steel, Hardened steel				Stainless steel	Cast iron, Nodular cast iron	Copper alloy	Aluminum alloy	Titanium alloy	Heat resistant alloy
		~40HRC	~50HRC	~55HRC	~68HRC						
			○	◎	◎		○				

Code key B258 Graphics category and identification B259 Cutting parameters B533 Non-standard customization B570-B571

2-flute ball nose end mills with straight shank



HMX-2BL/M/X

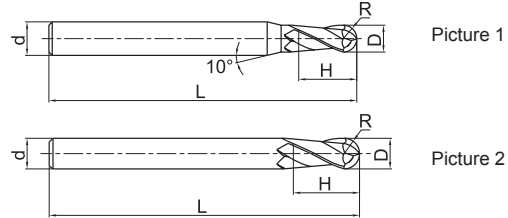

●HM-2B series with long shank.

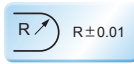
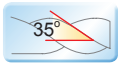

Type	Basic dimension(mm)					Number of teeth Z	Geometry	Stock
	D	R	d	H	L			
HMX-2BL-R1.0S	2.0	1.0	4	4	75	2	Picture 1	●
HMX-2BL-R1.0	2.0	1.0	6	4	75	2	Picture 1	●
HMX-2BL-R1.25S	2.5	1.25	4	5	75	2	Picture 1	●
HMX-2BL-R1.25	2.5	1.25	6	6	75	2	Picture 1	●
HMX-2BL-R1.5S	3.0	1.5	4	6	75	2	Picture 1	●
HMX-2BL-R1.5	3.0	1.5	6	6	75	2	Picture 1	●
HMX-2BL-R1.75S	3.5	1.75	4	8	75	2	Picture 1	●
HMX-2BL-R1.75	3.5	1.75	6	8	75	2	Picture 1	●
HMX-2BL-R2.0S	4.0	2.0	4	8	75	2	Picture 2	●
HMX-2BL-R2.0	4.0	2.0	6	8	75	2	Picture 1	●
HMX-2BL-R2.5	5.0	2.5	6	10	75	2	Picture 1	●
HMX-2BL-R2.75	5.5	2.75	6	12	75	2	Picture 1	●
HMX-2BL-R3.0	6.0	3.0	6	12	75	2	Picture 2	●
HMX-2BX-R3.0	6.0	3.0	6	12	100	2	Picture 2	●
HMX-2BL-R3.5	7.0	3.5	8	14	75	2	Picture 1	●
HMX-2BM-R4.0	8.0	4.0	8	16	75	2	Picture 2	●
HMX-2BL-R4.0	8.0	4.0	8	16	100	2	Picture 2	●
HMX-2BL-R4.5	9.0	4.5	10	18	100	2	Picture 1	●
HMX-2BL-R5.0	10.0	5.0	10	20	100	2	Picture 2	●
HMX-2BX-R5.0	10.0	5.0	10	20	150	2	Picture 2	●
HMX-2BL-R6.0	12.0	6.0	12	24	100	2	Picture 2	●
HMX-2BX-R6.0	12.0	6.0	12	24	150	2	Picture 2	●
HMX-2BL-R7.0	14.0	7.0	14	28	100	2	Picture 2	●
HMX-2BL-R8.0	16.0	8.0	16	32	150	2	Picture 2	●
HMX-2BL-R10.0	20.0	10.0	20	40	150	2	Picture 2	●

● Stock available ○ Make-to-order

Applicable workpiece material table ○Very suitable ○Suitable

Workpiece material											
Carbon steel	Alloy steel	Pre-hardened steel, Hardened steel				Stainless steel	Cast iron, Nodular cast iron	Copper alloy	Aluminum alloy	Titanium alloy	Heat resistant alloy
		~40HRC	~50HRC	~55HRC	~68HRC						
			○	●	●		○				

Code key **B258** Graphics category and identification **B259** Cutting parameters **B533** Non-standard customization **B570-B571**

Indexable milling tools
Solid carbide end mills
HMX series

HMX series for machining high hardness steel

2-flute ball nose end mills with straight shank, long neck and short cutting edge



HMX-2BFP

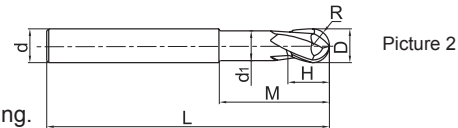
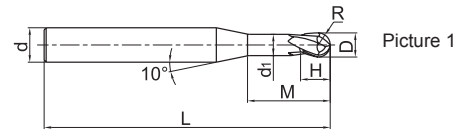

- Short cutting edge and high rigidity designed, applicable for heavy cutting.

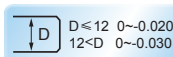
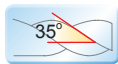

Type	Basic dimension(mm)							Number of teeth Z	Geometry	Stock
	D	R	H	d ₁	M	d	L			
HMX-2BFP-R0.5	1.0	0.5	1	0.95	2.5	6	75	2	Picture 1	●
HMX-2BFP-R0.75	1.5	0.75	1.5	1.45	3.0	6	75	2	Picture 1	●
HMX-2BFP-R1.0	2.0	1.0	2	1.95	4.0	6	75	2	Picture 1	●
HMX-2BFP-R1.5	3.0	1.5	3	2.85	6.0	6	75	2	Picture 1	●
HMX-2BFP-R2.0	4.0	2.0	4	3.85	8.0	6	75	2	Picture 1	●
HMX-2BFP-R2.5	5.0	2.5	5	4.85	10.0	6	75	2	Picture 1	●
HMX-2BFP-R3.0	6.0	3.0	6	5.8	12.0	6	75	2	Picture 2	●
HMX-2BFP-R4.0	8.0	4.0	8	7.8	16.0	8	100	2	Picture 2	●
HMX-2BFP-R5.0	10.0	5.0	10	9.6	20.0	10	100	2	Picture 2	●
HMX-2BFP-R6.0	12.0	6.0	12	11.5	24.0	12	100	2	Picture 2	●
HMX-2BFP-R8.0	16.0	8.0	16	15.5	32.0	16	150	2	Picture 2	●
HMX-2BFP-R10.0	20.0	10.0	20	19.5	40.0	20	150	2	Picture 2	●

● Stock available ○ Make-to-order

Indexable milling tools

Solid carbide end mills

HMX series

Applicable workpiece material table ○Very suitable ○Suitable

Workpiece material											
Carbon steel	Alloy steel	Pre-hardened steel, Hardened steel				Stainless steel	Cast iron, Nodular cast iron	Copper alloy	Aluminum alloy	Titanium alloy	Heat resistant alloy
		~40HRC	~50HRC	~55HRC	~68HRC						
			○	●	●		○				

Code key

B258

Graphics category and identification

B259

Cutting parameters

B533

Non-standard customization

B570-B571

4-flute ball nose end mills with straight shank



HMX-4B



- 4-flute ball nose end mill can operate with higher feed speed and machining efficiency, extending tool life in machining high-hardness workpiece.

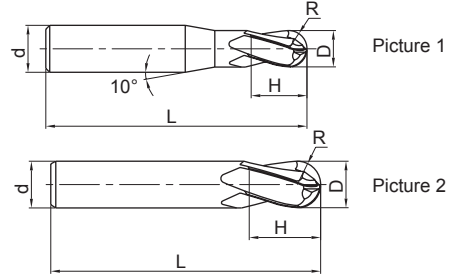
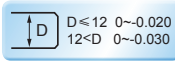
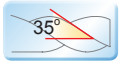

Type	Basic dimension(mm)					Number of teeth Z	Geometry	Stock
	D	R	d	H	L			
HMX-4B-R1.5	3.0	1.5	6	6	50	4	Picture 1	●
HMX-4B-R2.0	4.0	2.0	6	8	50	4	Picture 1	●
HMX-4B-R2.5	5.0	2.5	6	10	50	4	Picture 1	●
HMX-4B-R3.0	6.0	3.0	6	12	50	4	Picture 2	●
HMX-4B-R4.0	8.0	4.0	8	16	60	4	Picture 2	●
HMX-4B-R5.0	10.0	5.0	10	20	75	4	Picture 2	●
HMX-4B-R6.0	12.0	6.0	12	24	75	4	Picture 2	●
HMX-4B-R7.0	14.0	7.0	14	28	75	4	Picture 2	●
HMX-4B-R8.0	16.0	8.0	16	32	100	4	Picture 2	●
HMX-4B-R9.0	18.0	9.0	18	36	100	4	Picture 2	●
HMX-4B-R10.0	20.0	10.0	20	40	100	4	Picture 2	●

● Stock available ○ Make-to-order

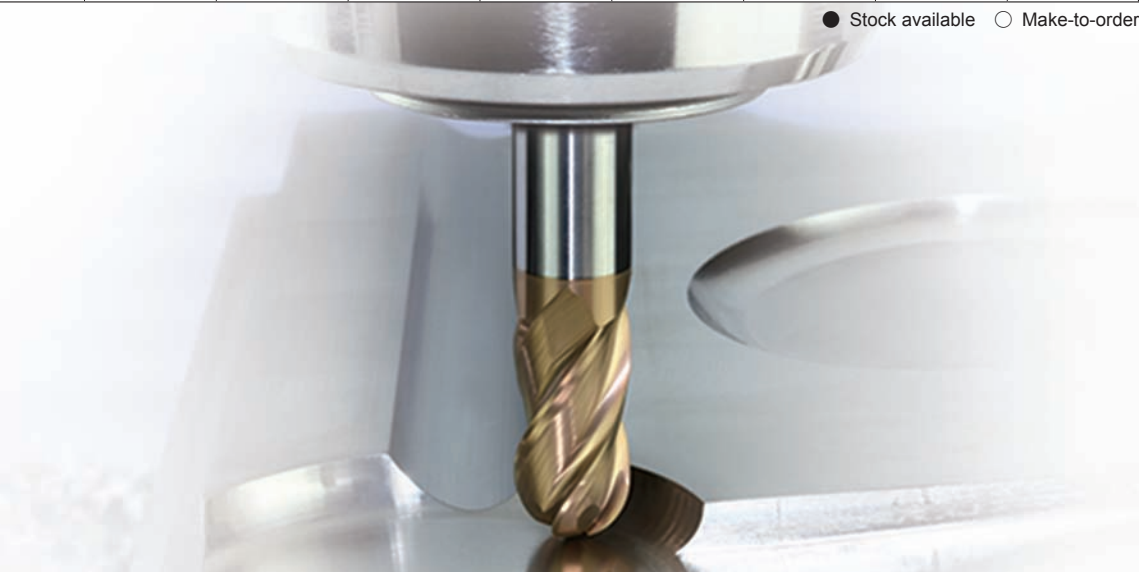

Applicable workpiece material table ○ Very suitable ○ Suitable

Workpiece material											
Carbon steel	Alloy steel	Pre-hardened steel, Hardened steel				Stainless steel	Cast iron, Nodular cast iron	Copper alloy	Aluminum alloy	Titanium alloy	Heat resistant alloy
		~40HRC	~50HRC	~55HRC	~68HRC						
			○	○	○		○				

Code key **B258** Graphics category and identification **B259** Cutting parameters **B534** Non-standard customization **B570-B571**

Indexable milling tools
Solid carbide end mills
HMX series

HMX series for machining high hardness steel

4-flute ball nose end mills with straight and long shank



HMX-4BL

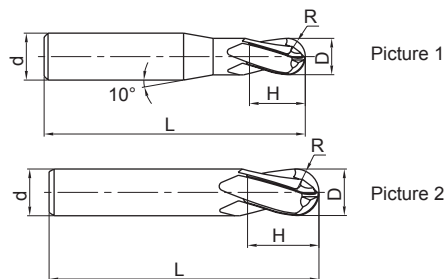

● HMX-4B series with long shank.

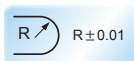
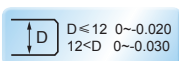
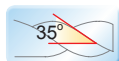

Type	Basic dimension(mm)					Number of teeth Z	Geometry	Stock
	D	R	d	H	L			
HMX-4BL-R1.5	3.0	1.5	6	6	75	4	Picture 1	○
HMX-4BL-R2.0	4.0	2.0	6	8	75	4	Picture 1	○
HMX-4BL-R2.5	5.0	2.5	6	10	75	4	Picture 1	○
HMX-4BL-R3.0	6.0	3.0	6	12	75	4	Picture 2	○
HMX-4BL-R4.0	8.0	4.0	8	16	100	4	Picture 2	○
HMX-4BL-R5.0	10.0	5.0	10	20	100	4	Picture 2	○
HMX-4BL-R6.0	12.0	6.0	12	24	100	4	Picture 2	○
HMX-4BL-R7.0	14.0	7.0	14	28	100	4	Picture 2	○
HMX-4BL-R8.0	16.0	8.0	16	32	150	4	Picture 2	○
HMX-4BL-R9.0	18.0	9.0	18	36	150	4	Picture 2	○
HMX-4BL-R10.0	20.0	10.0	20	40	150	4	Picture 2	○

● Stock available ○ Make-to-order

Indexable milling tools

Solid carbide end mills

HMX series

Applicable workpiece material table ○Very suitable ○Suitable

Workpiece material											
Carbon steel	Alloy steel	Pre-hardened steel, Hardened steel				Stainless steel	Cast iron, Nodular cast iron	Copper alloy	Aluminum alloy	Titanium alloy	Heat resistant alloy
		~40HRC	~50HRC	~55HRC	~68HRC						
			○	●	●		○				

Code key

B258

Graphics category and identification

B259

Cutting parameters

B534

Non-standard customization

B570-B571

2-flute tiny ball nose end mills with straight shank



HMX-2BS

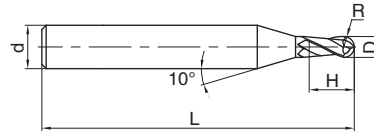

● Tiny diameter end mills can fully display high speed and high precision performances of machining center, often used for machining of precision components such as electronic part etc..

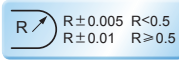
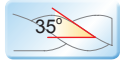

Type	Basic dimension(mm)					Number of teeth Z	Stock
	D	R	d	H	L		
HMX-2BS-R0.15	0.30	0.15	4	0.5	50	2	●
HMX-2BS-R0.20	0.40	0.20	4	0.6	50	2	●
HMX-2BS-R0.25	0.50	0.25	4	0.8	50	2	●
HMX-2BS-R0.30	0.60	0.30	4	0.9	50	2	●
HMX-2BS-R0.35	0.70	0.35	4	1.0	50	2	●
HMX-2BS-R0.40	0.80	0.40	4	1.2	50	2	●
HMX-2BS-R0.45	0.90	0.45	4	1.3	50	2	●
HMX-2BS-R0.50	1.00	0.50	4	1.5	50	2	●
HMX-2BS-R0.60	1.20	0.60	4	1.8	50	2	●
HMX-2BS-R0.70	1.40	0.70	4	2.0	50	2	●
HMX-2BS-R0.75	1.50	0.75	4	2.3	50	2	●
HMX-2BS-R0.80	1.60	0.80	4	2.5	50	2	●
HMX-2BS-R0.90	1.80	0.90	4	2.7	50	2	●
HMX-2BS-R1.00	2.00	1.00	4	3.0	50	2	●
HMX-2BS-R1.25	2.50	1.25	4	3.7	50	2	●
HMX-2BS-R1.50	3.00	1.50	4	4.5	50	2	●

● Stock available ○ Make-to-order

Indexable milling tools
Solid carbide end mills
HMX series

➤ Applicable workpiece material table ○Very suitable ○Suitable

Workpiece material											
Carbon steel	Alloy steel	Pre-hardened steel, Hardened steel				Stainless steel	Cast iron, Nodular cast iron	Copper alloy	Aluminum alloy	Titanium alloy	Heat resistant alloy
		~40HRC	~50HRC	~55HRC	~68HRC						
			○	○	○		○				





MILLING Solid Carbide End Mills

HMX series for machining high hardness steel

2-flute ball nose end mills with straight shank, long neck and short cutting edge



Deep ball nose slot

HMX-2BP

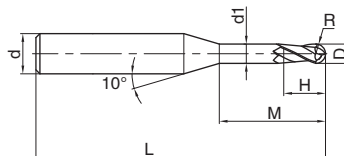

- Applicable for machining narrow slot and free-form surface.

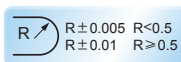
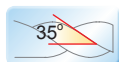

Type	Basic dimension(mm)							Number of teeth Z	Stock
	D	R	H	d ₁	M	d	L		
HMX-2BP-R0.15-M02	0.3	0.15	0.4	0.25	2	4	50	2	●
HMX-2BP-R0.15-M04	0.3	0.15	0.4	0.25	4	4	50	2	●
HMX-2BP-R0.2-M02	0.4	0.2	0.6	0.35	2	4	50	2	●
HMX-2BP-R0.2-M04	0.4	0.2	0.6	0.35	4	4	50	2	●
HMX-2BP-R0.25-M04	0.5	0.25	0.7	0.45	4	4	50	2	●
HMX-2BP-R0.25-M06	0.5	0.25	0.7	0.45	6	4	50	2	●
HMX-2BP-R0.3-M04	0.6	0.3	0.9	0.55	4	4	50	2	●
HMX-2BP-R0.3-M06	0.6	0.3	0.9	0.55	6	4	50	2	●
HMX-2BP-R0.3-M08	0.6	0.3	0.9	0.55	8	4	50	2	●
HMX-2BP-R0.4-M04	0.8	0.4	1.2	0.75	4	4	50	2	●
HMX-2BP-R0.4-M06	0.8	0.4	1.2	0.75	6	4	50	2	●
HMX-2BP-R0.4-M08	0.8	0.4	1.2	0.75	8	4	50	2	●
HMX-2BP-R0.4-M10	0.8	0.4	1.2	0.75	10	4	50	2	●
HMX-2BP-R0.5-M04	1.0	0.5	1.5	0.95	4	4	50	2	●
HMX-2BP-R0.5-M06	1.0	0.5	1.5	0.95	6	4	50	2	●
HMX-2BP-R0.5-M08	1.0	0.5	1.5	0.95	8	4	50	2	●
HMX-2BP-R0.5-M10	1.0	0.5	1.5	0.95	10	4	50	2	●
HMX-2BP-R0.5-M12	1.0	0.5	1.5	0.95	12	4	50	2	●
HMX-2BP-R0.6-M06	1.2	0.6	1.8	1.15	6	4	50	2	●
HMX-2BP-R0.6-M08	1.2	0.6	1.8	1.15	8	4	50	2	●
HMX-2BP-R0.6-M12	1.2	0.6	1.8	1.15	12	4	50	2	●
HMX-2BP-R0.6-M16	1.2	0.6	1.8	1.15	16	4	50	2	●
HMX-2BP-R0.75-M08	1.5	0.75	2.3	1.45	8	4	50	2	●
HMX-2BP-R0.75-M12	1.5	0.75	2.3	1.45	12	4	50	2	●
HMX-2BP-R0.75-M16	1.5	0.75	2.3	1.45	16	4	50	2	●
HMX-2BP-R1.0-M06	2.0	1.0	3.0	1.95	6	4	50	2	●
HMX-2BP-R1.0-M08	2.0	1.0	3.0	1.95	8	4	50	2	●
HMX-2BP-R1.0-M10	2.0	1.0	3.0	1.95	10	4	50	2	●
HMX-2BP-R1.0-M12	2.0	1.0	3.0	1.95	12	4	50	2	●
HMX-2BP-R1.0-M16	2.0	1.0	3.0	1.95	16	4	50	2	●
HMX-2BP-R1.0-M20	2.0	1.0	3.0	1.95	20	4	50	2	●

Applicable workpiece material table ● Very suitable ○ Suitable

● Stock available ○ Make-to-order

Workpiece material											
Carbon steel	Alloy steel	Pre-hardened steel, Hardened steel				Stainless steel	Cast iron, Nodular cast iron	Copper alloy	Aluminum alloy	Titanium alloy	Heat resistant alloy
		~40HRC	~50HRC	~55HRC	~68HRC						
			○	●	●		○				

Code key

B258

Graphics category and identification

B259

Cutting parameters

B536-B537

Non-standard customization

B570-B571

2-flute ball nose end mills with straight shank, long neck and short cutting edge



HMX-2BP

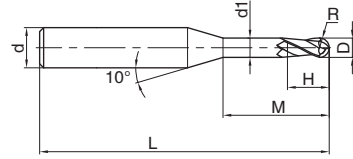

- Applicable for machining narrow slot and free-form surface

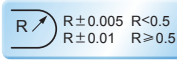
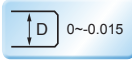
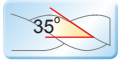

Type	Basic dimension(mm)							Number of teeth Z	Stock
	D	R	H	d ₁	M	d	L		
HMX-2BP-R1.25-M08	2.5	1.25	3.7	2.4	8	4	50	2	●
HMX-2BP-R1.25-M12	2.5	1.25	3.7	2.4	12	4	50	2	●
HMX-2BP-R1.25-M16	2.5	1.25	3.7	2.4	16	4	60	2	●
HMX-2BP-R1.25-M20	2.5	1.25	3.7	2.4	20	4	60	2	●
HMX-2BP-R1.5-M08	3.0	1.5	4.5	2.85	8	6	50	2	●
HMX-2BP-R1.5-M10	3.0	1.5	4.5	2.85	10	6	50	2	●
HMX-2BP-R1.5-M12	3.0	1.5	4.5	2.85	12	6	50	2	●
HMX-2BP-R1.5-M16	3.0	1.5	4.5	2.85	16	6	60	2	●
HMX-2BP-R1.5-M20	3.0	1.5	4.5	2.85	20	6	60	2	●
HMX-2BP-R2.0-M10	4.0	2.0	6.0	3.85	10	6	60	2	●
HMX-2BP-R2.0-M16	4.0	2.0	6.0	3.85	16	6	60	2	●
HMX-2BP-R2.0-M20	4.0	2.0	6.0	3.85	20	6	60	2	●
HMX-2BP-R2.0-M25	4.0	2.0	6.0	3.85	25	6	60	2	●
HMX-2BP-R2.5-M16	5.0	2.5	7.5	4.85	16	6	60	2	●
HMX-2BP-R2.5-M25	5.0	2.5	7.5	4.85	25	6	70	2	●

● Stock available ○ Make-to-order

Tool type: HM-2BP-R0.3-M08
 Dimensions: R0.3mm
 Workpiece material: S136(52HRC)
 Rotating speed: 30000r/min
 Feed speed: 200mm/min
 Axial cutting depth: $a_p=0.02\text{mm}$
 Radial cutting depth: $a_e=0.04\text{mm}$
 Cutting style: contour machining (mould of car light)
 Cooling system: air blow
 Machine tool: MIKRON HSM 800



End mill	HM-2BP-R0.3-M08	Similar product of company A
Cutting time	300min	180min
Abrasion value	0.025mm	0.048mm

Abrasion condition



Applicable workpiece material table ○Very suitable ○Suitable

Workpiece material											
Carbon steel	Alloy steel	Pre-hardened steel, Hardened steel				Stainless steel	Cast iron, Nodular cast iron	Copper alloy	Aluminum alloy	Titanium alloy	Heat resistant alloy
		~40HRC	~50HRC	~55HRC	~68HRC						
			○	○	○		○				

Code key

B258

Graphics category and identification B259

Cutting parameters B536-B537

Non-standard customization B570-B571

Indexable milling tools
Solid carbide end mills
HMX series

HMX series for machining high hardness steel

4-flute R end mills with straight shank



HMX-4R

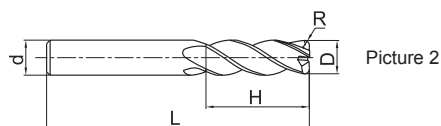
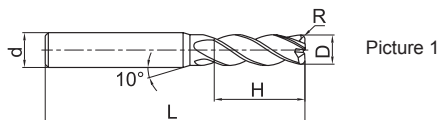

● Wide applications, applicable for several machining conditions.

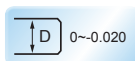

Type	Basic dimension(mm)					Number of teeth Z	Geometry	Stock
	D	R	d	H	L			
HMX-4R-D1.0R0.2	1.0	0.2	4	3	50	4	Picture 1	●
HMX-4R-D1.5R0.2	1.5	0.2	4	4	50	4	Picture 1	●
HMX-4R-D2.0R0.2	2.0	0.2	4	6	50	4	Picture 1	●
HMX-4R-D2.0R0.5	2.0	0.5	4	6	50	4	Picture 1	●
HMX-4R-D2.5R0.2	2.5	0.2	4	8	50	4	Picture 1	●
HMX-4R-D2.5R0.5	2.5	0.5	4	8	50	4	Picture 1	●
HMX-4R-D3.0R0.2	3.0	0.2	4	8	50	4	Picture 1	●
HMX-4R-D3.0R0.5	3.0	0.5	4	8	50	4	Picture 1	●
HMX-4R-D4.0R0.2	4.0	0.2	4	10	50	4	Picture 2	●
HMX-4R-D4.0R0.3	4.0	0.3	4	10	50	4	Picture 2	●
HMX-4R-D4.0R0.5	4.0	0.5	4	10	50	4	Picture 2	●
HMX-4R-D5.0R0.2	5.0	0.2	6	13	50	4	Picture 2	●
HMX-4R-D5.0R0.5	5.0	0.5	6	13	50	4	Picture 1	●
HMX-4R-D5.0R1.0	5.0	1.0	6	13	50	4	Picture 1	●
HMX-4R-D6.0R0.2	6.0	0.2	6	16	50	4	Picture 2	●
HMX-4R-D6.0R0.5	6.0	0.5	6	16	50	4	Picture 2	●
HMX-4R-D6.0R1.0	6.0	1.0	6	16	50	4	Picture 2	●

● Stock available ○ Make-to-order

Indexable milling tools

Solid carbide end mills

HMX series

Applicable workpiece material table ○Very suitable ○Suitable

Workpiece material											
Carbon steel	Alloy steel	Pre-hardened steel, Hardened steel				Stainless steel	Cast iron, Nodular cast iron	Copper alloy	Aluminum alloy	Titanium alloy	Heat resistant alloy
		~40HRC	~50HRC	~55HRC	~68HRC						
			○	○	○		○				

Code key

B258

Graphics category and identification

B259

Cutting parameters

B538

Non-standard customization

B570-B571

4-flute R end mills with straight shank



HMX-4R

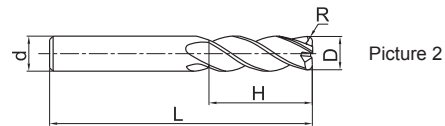
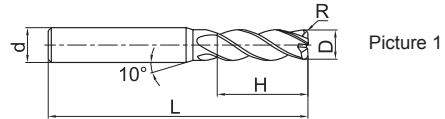

● Wide applications, applicable for several machining conditions.

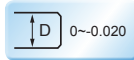
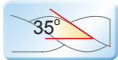

Type	Basic dimension(mm)					Number of teeth Z	Geometry	Stock
	D	R	d	H	L			
HMX-4R-D8.0R0.2	8.0	0.2	8	20	60	4	Picture 2	●
HMX-4R-D8.0R0.5	8.0	0.5	8	20	60	4	Picture 2	●
HMX-4R-D8.0R1.0	8.0	1.0	8	20	60	4	Picture 2	●
HMX-4R-D10.0R0.2	10.0	0.2	10	25	75	4	Picture 2	●
HMX-4R-D10.0R0.5	10.0	0.5	10	25	75	4	Picture 2	●
HMX-4R-D10.0R1.0	10.0	1.0	10	25	75	4	Picture 2	●
HMX-4R-D10.0R2.0	10.0	2.0	10	25	75	4	Picture 2	●
HMX-4R-D10.0R3.0	10.0	3.0	10	25	75	4	Picture 2	●
HMX-4R-D12.0R0.2	12.0	0.2	12	30	75	4	Picture 2	●
HMX-4R-D12.0R0.5	12.0	0.5	12	30	75	4	Picture 2	●
HMX-4R-D12.0R1.0	12.0	1.0	12	30	75	4	Picture 2	●
HMX-4R-D12.0R2.0	12.0	2.0	12	30	75	4	Picture 2	●
HMX-4R-D12.0R3.0	12.0	3.0	12	30	75	4	Picture 2	●

● Stock available ○ Make-to-order

Indexable milling tools
Solid carbide end mills
HMX series

➤ Applicable workpiece material table ○ Very suitable ○ Suitable

Workpiece material											
Carbon steel	Alloy steel	Pre-hardened steel, Hardened steel				Stainless steel	Cast iron, Nodular cast iron	Copper alloy	Aluminum alloy	Titanium alloy	Heat resistant alloy
		~40HRC	~50HRC	~55HRC	~68HRC						
			○	○	○		○				





B MILLING / Solid Carbide End Mills

HMX series for machining high hardness steel

4-flute R end mills with long shank



HMX-4RBL/M/X



● HMX-4R series with long shank.

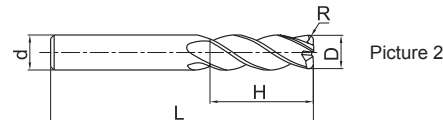
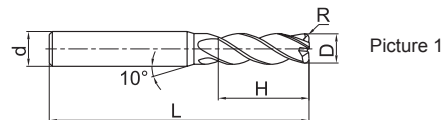
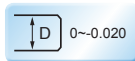
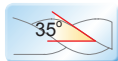

Type	Basic dimension(mm)					Number of teeth Z	Geometry	Stock
	D	R	d	H	L			
HMX-4RBL-D4.0R0.2S	4.0	0.2	4	10	75	4	Picture 2	●
HMX-4RBL-D4.0R0.2	4.0	0.2	6	10	75	4	Picture 1	●
HMX-4RBL-D4.0R0.5S	4.0	0.5	4	10	75	4	Picture 2	●
HMX-4RBL-D4.0R0.5	4.0	0.5	6	10	75	4	Picture 1	●
HMX-4RBL-D6.0R0.2	6.0	0.2	6	16	75	4	Picture 2	●
HMX-4RBX-D6.0R0.2	6.0	0.2	6	16	100	4	Picture 2	●
HMX-4RBL-D6.0R0.5	6.0	0.5	6	16	75	4	Picture 2	●
HMX-4RBX-D6.0R0.5	6.0	0.5	6	16	100	4	Picture 2	●
HMX-4RBL-D6.0R1.0	6.0	1.0	6	16	75	4	Picture 2	●
HMX-4RBX-D6.0R1.0	6.0	1.0	6	16	100	4	Picture 2	●
HMX-4RBM-D8.0R0.2	8.0	0.2	8	20	75	4	Picture 2	●
HMX-4RBL-D8.0R0.2	8.0	0.2	8	20	100	4	Picture 2	●
HMX-4RBM-D8.0R0.5	8.0	0.5	8	20	75	4	Picture 2	●
HMX-4RBL-D8.0R0.5	8.0	0.5	8	20	100	4	Picture 2	●
HMX-4RBM-D8.0R1.0	8.0	1.0	8	20	75	4	Picture 2	●
HMX-4RBL-D8.0R1.0	8.0	1.0	8	20	100	4	Picture 2	●
HMX-4RBL-D10.0R0.2	10.0	0.2	10	25	100	4	Picture 2	●
HMX-4RBX-D10.0R0.2	10.0	0.2	10	25	150	4	Picture 2	●
HMX-4RBL-D10.0R0.5	10.0	0.5	10	25	100	4	Picture 2	●
HMX-4RBX-D10.0R0.5	10.0	0.5	10	25	150	4	Picture 2	●
HMX-4RBL-D10.0R1.0	10.0	1.0	10	25	100	4	Picture 2	●
HMX-4RBX-D10.0R1.0	10.0	1.0	10	25	150	4	Picture 2	●
HMX-4RBL-D10.0R2.0	10.0	2.0	10	25	100	4	Picture 2	●
HMX-4RBX-D10.0R2.0	10.0	2.0	10	25	150	4	Picture 2	●
HMX-4RBL-D12.0R0.2	12.0	0.2	12	30	100	4	Picture 2	●
HMX-4RBX-D12.0R0.2	12.0	0.2	12	30	150	4	Picture 2	●
HMX-4RBL-D12.0R0.5	12.0	0.5	12	30	100	4	Picture 2	●
HMX-4RBX-D12.0R0.5	12.0	0.5	12	30	150	4	Picture 2	●
HMX-4RBL-D12.0R1.0	12.0	1.0	12	30	100	4	Picture 2	●
HMX-4RBX-D12.0R1.0	12.0	1.0	12	30	150	4	Picture 2	●
HMX-4RBL-D12.0R2.0	12.0	2.0	12	30	100	4	Picture 2	●
HMX-4RBX-D12.0R2.0	12.0	2.0	12	30	150	4	Picture 2	●

Applicable workpiece material table ● Very suitable ○ Suitable

● Stock available ○ Make-to-order

Workpiece material											
Carbon steel	Alloy steel	Pre-hardened steel, Hardened steel				Stainless steel	Cast iron, Nodular cast iron	Copper alloy	Aluminum alloy	Titanium alloy	Heat resistant alloy
		~40HRC	~50HRC	~55HRC	~68HRC						
			○	●	●		○				

Code key

B258

Graphics category and identification

B259

Cutting parameters

B538

Non-standard customization

B570-B571

HMX series for machining high hardness steel

4-flute R end mills with straight shank and short cutting edge



HMX-4RF

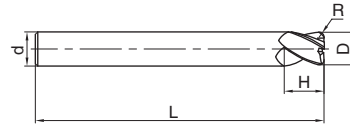

- High-rigidity short edge design, for cutting with high feed rate at high speed.

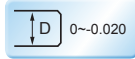
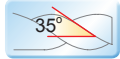

Type	Basic dimension(mm)					Number of teeth Z	Stock
	D	R	d	H	L		
HMX-4RF-D6.0R0.5	6.0	0.5	6	6	50	4	●
HMX-4RF-D6.0R1.0	6.0	1.0	6	6	50	4	●
HMX-4RF-D8.0R0.5	8.0	0.5	8	8	60	4	●
HMX-4RF-D8.0R1.0	8.0	1.0	8	8	60	4	●
HMX-4RF-10.0R0.5	10.0	0.5	10	10	75	4	●
HMX-4RF-D10.0R1.0	10.0	1.0	10	10	75	4	●
HMX-4RF-D10.0R2.0	10.0	2.0	10	10	75	4	●
HMX-4RF-D12.0R0.5	12.0	0.5	12	12	75	4	●
HMX-4RF-D12.0R1.0	12.0	1.0	12	12	75	4	●
HMX-4RF-D12.0R2.0	12.0	2.0	12	12	75	4	●

● Stock available ○ Make-to-order

Indexable milling tools

Solid carbide end mills

HMX series

Applicable workpiece material table ● Very suitable ○ Suitable

Workpiece material											
Carbon steel	Alloy steel	Pre-hardened steel, Hardened steel				Stainless steel	Cast iron, Nodular cast iron	Copper alloy	Aluminum alloy	Titanium alloy	Heat resistant alloy
		~40HRC	~50HRC	~55HRC	~68HRC						
			○	●	●		○				



HMX series for machining high hardness steel

4-flute R end mills with straight shank, long neck and short cutting edge



HMX-4RP

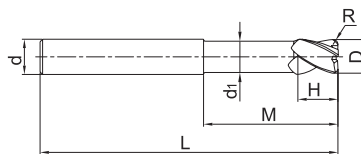

● Long shank and short cutting edge designed for deep cavity milling.

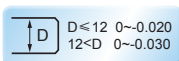
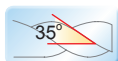

Type	Basic dimension(mm)							Number of teeth Z	Stock
	D	R	d	d ₁	H	M	L		
HMX-4RP-D6.0R0.5	6.0	0.5	6	5.8	6	18	75	4	●
HMX-4RP-D6.0R1.0	6.0	1.0	6	5.8	6	18	75	4	●
HMX-4RP-D8.0R0.5	8.0	0.5	8	7.8	8	24	100	4	●
HMX-4RP-D8.0R1.0	8.0	1.0	8	7.8	8	24	100	4	●
HMX-4RP-D10.0R0.5	10.0	0.5	10	9.6	10	30	100	4	●
HMX-4RP-D10.0R1.0	10.0	1.0	10	9.6	10	30	100	4	●
HMX-4RP-D10.0R2.0	10.0	2.0	10	9.6	10	30	100	4	●
HMX-4RP-D12.0R0.5	12.0	0.5	12	11.5	12	36	100	4	●
HMX-4RP-D12.0R1.0	12.0	1.0	12	11.5	12	36	100	4	●
HMX-4RP-D12.0R2.0	12.0	2.0	12	11.5	12	36	100	4	●
HMX-4RP-D16.0R1.0	16.0	1.0	16	15.5	16	40	150	4	●
HMX-4RP-D16.0R2.0	16.0	2.0	16	15.5	16	40	150	4	●

● Stock available ○ Make-to-order

Indexable milling tools

Solid carbide end mills

HMX series

Applicable workpiece material table ○ Very suitable ○ Suitable

Workpiece material											
Carbon steel	Alloy steel	Pre-hardened steel, Hardened steel				Stainless steel	Cast iron, Nodular cast iron	Copper alloy	Aluminum alloy	Titanium alloy	Heat resistant alloy
		~40HRC	~50HRC	~55HRC	~68HRC						
			○	○	○		○				

Code key

B258

Graphics category and identification

B259

Cutting parameters

B538

Non-standard customization

B570-B571

HMX series for machining high hardness steel

6-flute R end mills with straight shank, long neck, short cutting edge and high rigidity



HMX-6R-MAX

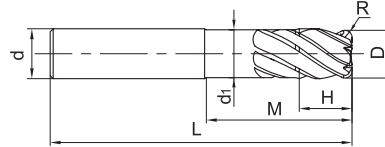

● High rigidity short cutting edge designed for high cutting speed, high feed, high efficient machining

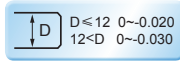

Type	Basic dimension(mm)							Number of teeth Z	Stock
	D	R	d	H	d ₁	M	L		
HMX-6R-D6R0.5-MAX	6.0	0.5	6	6	5.8	16	50	6	○
HMX-6R-D8R1.0-MAX	8.0	1.0	8	8	7.8	24	60	6	○
HMX-6R-D10R1.0-MAX	10.0	1.0	10	10	9.8	30	75	6	○
HMX-6R-D12R1.0-MAX	12.0	1.0	12	12	11.5	36	75	6	○
HMX-6R-D16R1.0-MAX	16.0	1.0	16	16	15.5	48	100	6	○
HMX-6R-D20R1.0-MAX	20.0	1.0	20	20	19.5	50	100	6	○

● Stock available ○ Make-to-order

Indexable milling tools

Solid carbide end mills

HMX series

➤ Applicable workpiece material table ○ Very suitable ○ Suitable

Workpiece material											
Carbon steel	Alloy steel	Pre-hardened steel, Hardened steel				Stainless steel	Cast iron, Nodular cast iron	Copper alloy	Aluminum alloy	Titanium alloy	Heat resistant alloy
		~40HRC	~50HRC	~55HRC	~68HRC						
			○	○	○		○				

Code key **B258**

Graphics category and identification **B259**

Cutting parameters **B539**

Non-standard customization **B570-B571**

TMM series

end mills for titanium machining



- High flexural strength, can significantly avoid the risks of premature chipping, suitable for titanium alloy materials milling machining
- Polished finish for both flank and rake face improves the surface smoothness, reduces friction, reduces cutting force and temperature, reduces abrasive wear caused by smearing
- Adopted differential pitch structure leads to high-efficiency milling with low vibration.

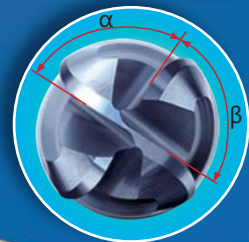
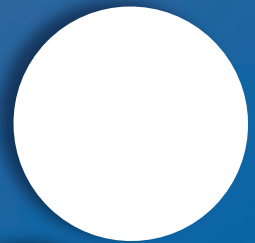

$\alpha \neq \beta$

Application field

Suitable for Aerospace industries applications or machining titanium alloy parts, improve machining efficiency for the customers;

Suitable for finishing titanium alloy parts in Aerospace industries to improve the dimensional accuracy of the parts.

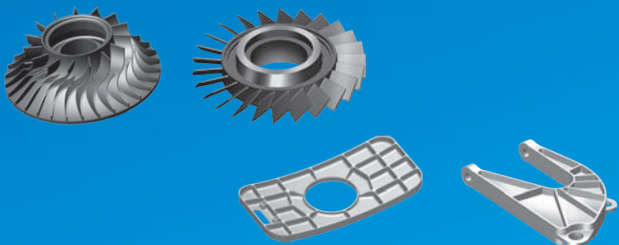

Longer tool life

Machining component: housings and casings

Workpiece material: TC4

Cutting tool: TM-5R-D16.0R0.5

Cutting parameters: S=720r/min,

F=128~160mm/min,

ap=13~15.3mm,

ae=8~16mm

CNC Machine type: planomiller

Method: Slot milling, Side face milling

Cooling method: Emulsion

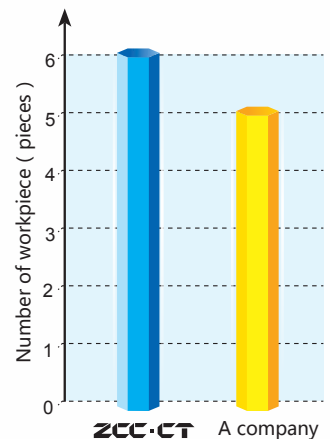

Test result: ZCC-CT product processed 6 components, product from A company only processed 5 components.

4-flute flattened end mills with straight shank



TM-4E

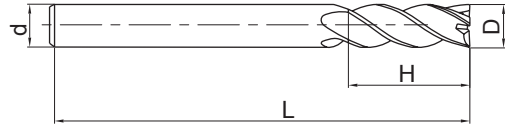

● Long shank, short cutting edge design, suitable for deep cavity milling .

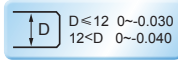
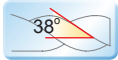

Type	Basic dimension(mm)				Number of teeth Z	Stock
	D	d	H	L		
TM-4E-D6.0	6.0	6	16	50	4	●
TM-4E-D8.0	8.0	8	20	60	4	●
TM-4E-D10.0	10.0	10	25	75	4	●
TM-4E-D12.0	12.0	12	30	75	4	●
TM-4E-D14.0	14.0	14	35	90	4	●
TM-4E-D16.0	16.0	16	35	90	4	●
TM-4E-D20.0	20.0	20	45	100	4	●
TM-4E-D25.0	25.0	25	50	110	4	●

● Stock available ○ Make-to-order

Indexable milling tools

Solid carbide end mills

TM series

Applicable workpiece material table ○Very suitable ○Suitable

Workpiece material											
Carbon steel	Alloy steel	Pre-hardened steel、Hardened steel				Stainless steel	Cast iron, Nodular cast iron	Copper alloy	Aluminum alloy	Titanium alloy	Heat resistant alloy
		~40HRC	~50HRC	~55HRC	~68HRC						
○	○					○				○	○



TM series for titanium alloy machining

4-flute ball nose end mill



TM-4B

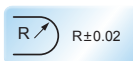
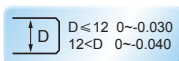
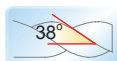
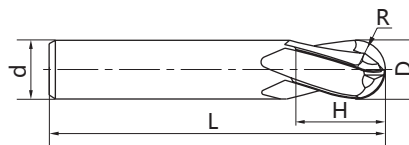

Type	Basic dimension(mm)					Number of teeth Z	Stock
	D	R	d	H	L		
TM-4B-R3.0	6.0	3.0	6	9	50	4	●
TM-4B-R4.0	8.0	4.0	8	12	60	4	●
TM-4B-R5.0	10.0	5.0	10	15	75	4	●
TM-4B-R6.0	12.0	6.0	12	18	75	4	●
TM-4B-R8.0	16.0	8.0	16	24	85	4	●
TM-4B-R10.0	20.0	10.0	20	30	100	4	●

● Stock available ○ Make-to-order

Indexable milling tools

Solid carbide end mills

TM series

Applicable workpiece material table ○Very suitable ○Suitable

Workpiece material											
Carbon steel	Alloy steel	Pre-hardened steel, Hardened steel				Stainless steel	Cast iron, Nodular cast iron	Copper alloy	Aluminum alloy	Titanium alloy	Heat resistant alloy
		~40HRC	~50HRC	~55HRC	~68HRC						
○	○					○				○	○

Code key

B258

Graphics category and identification

B259

Cutting parameters

B540

Non-standard customization

B570-B571

TM series for titanium alloy machining

4-flute R end mills with straight shank



TM-4R

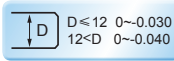
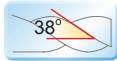
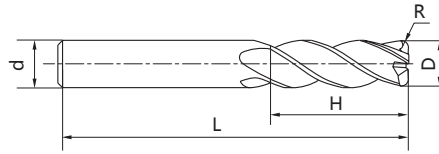

Type	Basic dimension(mm)					Number of teeth Z	Stock
	D	R	d	H	L		
TM-4R-D6.0R0.2	6.0	0.2	6	16	50	4	●
TM-4R-D6.0R0.3	6.0	0.3	6	16	50	4	●
TM-4R-D6.0R0.5	6.0	0.5	6	16	50	4	●
TM-4R-D6.0R0.75	6.0	0.75	6	16	50	4	●
TM-4R-D6.0R1.0	6.0	1.0	6	16	50	4	●
TM-4R-D8.0R0.2	8.0	0.2	8	20	60	4	●
TM-4R-D8.0R0.3	8.0	0.3	8	20	60	4	●
TM-4R-D8.0R0.5	8.0	0.5	8	20	60	4	●
TM-4R-D8.0R0.75	8.0	0.75	8	20	60	4	●
TM-4R-D8.0R1.0	8.0	1.0	8	20	60	4	●
TM-4R-D8.0R2.0	8.0	2.0	8	20	60	4	●
TM-4R-D10.0R0.2	10.0	0.2	10	25	75	4	●
TM-4R-D10.0R0.3	10.0	0.3	10	25	75	4	●
TM-4R-D10.0R0.5	10.0	0.5	10	25	75	4	●
TM-4R-D10.0R0.75	10.0	0.75	10	25	75	4	●
TM-4R-D10.0R1.0	10.0	1.0	10	25	75	4	●
TM-4R-D10.0R1.5	10.0	1.5	10	25	75	4	●
TM-4R-D10.0R2.0	10.0	2.0	10	25	75	4	●
TM-4R-D12.0R0.2	12.0	0.2	12	30	75	4	●
TM-4R-D12.0R0.3	12.0	0.3	12	30	75	4	●

● Stock available ○ Make-to-order

Indexable milling tools

Solid carbide end mills

TM series

Applicable workpiece material table ○ Very suitable ○ Suitable

Workpiece material											
Carbon steel	Alloy steel	Pre-hardened steel, Hardened steel				Stainless steel	Cast iron, Nodular cast iron	Copper alloy	Aluminum alloy	Titanium alloy	Heat resistant alloy
		~40HRC	~50HRC	~55HRC	~68HRC						
○	○					○				○	○



TM series for titanium alloy machining

4-flute R end mills with straight shank



TM-4R

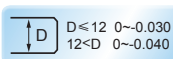
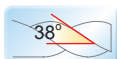
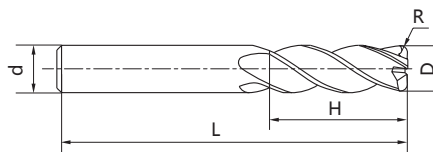

Type	Basic dimension(mm)					Number of teeth Z	Stock
	D	R	d	H	L		
TM-4R-D12.0R0.5	12.0	0.5	12	30	75	4	●
TM-4R-D12.0R0.75	12.0	0.75	12	30	75	4	●
TM-4R-D12.0R1.0	12.0	1.0	12	30	75	4	●
TM-4R-D12.0R1.5	12.0	1.5	12	30	75	4	●
TM-4R-D12.0R2.0	12.0	2.0	12	30	75	4	●
TM-4R-D12.0R2.5	12.0	2.5	12	30	75	4	●
TM-4R-D12.0R3.0	12.0	3.0	12	30	75	4	●
TM-4R-D14.0R0.2	14.0	0.2	14	35	90	4	●
TM-4R-D14.0R0.3	14.0	0.3	14	35	90	4	●
TM-4R-D14.0R0.5	14.0	0.5	14	35	90	4	●
TM-4R-D14.0R0.75	14.0	0.75	14	35	90	4	●
TM-4R-D14.0R1.0	14.0	1.0	14	35	90	4	●
TM-4R-D14.0R1.5	14.0	1.5	14	35	90	4	●
TM-4R-D14.0R2.0	14.0	2.0	14	35	90	4	●
TM-4R-D14.0R2.5	14.0	2.5	14	35	90	4	●
TM-4R-D14.0R3.0	14.0	3.0	14	35	90	4	●
TM-4R-D16.0R0.2	16.0	0.2	16	35	90	4	●
TM-4R-D16.0R0.3	16.0	0.3	16	35	90	4	●
TM-4R-D16.0R0.5	16.0	0.5	16	35	90	4	●

● Stock available ○ Make-to-order

Indexable milling tools

Solid carbide end mills

TM series

Applicable workpiece material table ○ Very suitable ○ Suitable

Workpiece material											
Carbon steel	Alloy steel	Pre-hardened steel, Hardened steel				Stainless steel	Cast iron, Nodular cast iron	Copper alloy	Aluminum alloy	Titanium alloy	Heat resistant alloy
		~40HRC	~50HRC	~55HRC	~68HRC						
○	○					○				○	○

Code key

B258

Graphics category and identification

B259

Cutting parameters

B540

Non-standard customization

B570-B571

TM series for titanium alloy machining

4-flute R end mills with straight shank



TM-4R

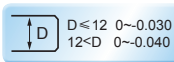
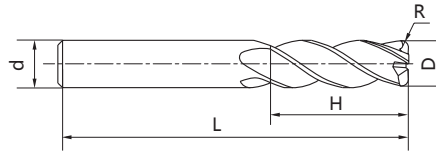

Type	Basic dimension(mm)					Number of teeth Z	Stock
	D	R	d	H	L		
TM-4R-D16.0R0.75	16.0	0.75	16	35	90	4	●
TM-4R-D16.0R1.0	16.0	1.0	16	35	90	4	●
TM-4R-D16.0R1.5	16.0	1.5	16	35	90	4	●
TM-4R-D16.0R2.0	16.0	2.0	16	35	90	4	●
TM-4R-D16.0R2.5	16.0	2.5	16	35	90	4	●
TM-4R-D16.0R3.0	16.0	3.0	16	35	90	4	●
TM-4R-D16.0R4.0	16.0	4.0	16	35	90	4	●
TM-4R-D20.0R0.2	20.0	0.2	20	45	100	4	●
TM-4R-D20.0R0.3	20.0	0.3	20	45	100	4	●
TM-4R-D20.0R0.5	20.0	0.5	20	45	100	4	●
TM-4R-D20.0R0.75	20.0	0.75	20	45	100	4	●
TM-4R-D20.0R1.0	20.0	1.0	20	45	100	4	●
TM-4R-D20.0R1.5	20.0	1.5	20	45	100	4	●
TM-4R-D20.0R2.0	20.0	2.0	20	45	100	4	●
TM-4R-D20.0R2.5	20.0	2.5	20	45	100	4	●
TM-4R-D20.0R3.0	20.0	3.0	20	45	100	4	●
TM-4R-D20.0R4.0	20.0	4.0	20	45	100	4	●
TM-4R-D25.0R1.0	25.0	1.0	25	50	110	4	●
TM-4R-D25.0R2.0	25.0	2.0	25	50	110	4	●
TM-4R-D25.0R3.0	25.0	3.0	25	50	110	4	●
TM-4R-D25.0R4.0	25.0	4.0	25	50	110	4	●
TM-4R-D25.0R5.0	25.0	5.0	25	50	110	4	●

● Stock available ○ Make-to-order

Indexable milling tools

Solid carbide end mills

TM series

Applicable workpiece material table ○Very suitable ○Suitable

Workpiece material											
Carbon steel	Alloy steel	Pre-hardened steel, Hardened steel				Stainless steel	Cast iron, Nodular cast iron	Copper alloy	Aluminum alloy	Titanium alloy	Heat resistant alloy
		~40HRC	~50HRC	~55HRC	~68HRC						
○	○					○				○	○



TM series for titanium alloy machining

4-flute R end mills with long neck, straight shank



TM-4RP

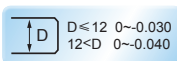
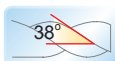
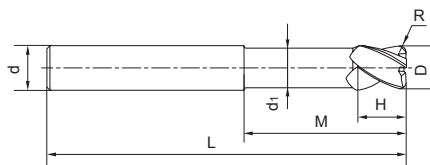

Type	Basic dimension(mm)							Number of teeth Z	Stock
	D	R	d	d ₁	H	M	L		
TM-4RP-D8.0R0.5	8.0	0.5	8	7.4	16	25	75	4	●
TM-4RP-D8.0R1.0	8.0	1.0	8	7.4	16	25	75	4	●
TM-4RP-D10.0R0.5	10.0	0.5	10	9.4	20	32	75	4	●
TM-4RP-D10.0R1.0	10.0	1.0	10	9.4	20	32	75	4	●
TM-4RP-D10.0R2.0	10.0	2.0	10	9.4	20	32	75	4	●
TM-4RP-D10.0R3.0	10.0	3.0	10	9.4	20	32	75	4	●
TM-4RP-D12.0R0.5	12.0	0.5	12	11.4	24	40	90	4	●
TM-4RP-D12.0R1.0	12.0	1.0	12	11.4	24	40	90	4	●
TM-4RP-D12.0R2.0	12.0	2.0	12	11.4	24	40	90	4	●
TM-4RP-D12.0R3.0	12.0	3.0	12	11.4	24	40	90	4	●
TM-4RP-D16.0R0.5	16.0	0.5	16	15.0	32	50	100	4	●
TM-4RP-D16.0R1.0	16.0	1.0	16	15.0	32	50	100	4	●
TM-4RP-D16.0R2.0	16.0	2.0	16	15.0	32	50	100	4	●
TM-4RP-D16.0R3.0	16.0	3.0	16	15.0	32	50	100	4	●
TM-4RP-D20.0R0.5	20.0	0.5	20	19.0	35	60	110	4	●
TM-4RP-D20.0R1.0	20.0	1.0	20	19.0	35	60	110	4	●
TM-4RP-D20.0R2.0	20.0	2.0	20	19.0	35	60	110	4	●
TM-4RP-D20.0R3.0	20.0	3.0	20	19.0	35	60	110	4	●
TM-4RP-D25.0R1.0	25.0	1.0	25	24.0	45	75	150	4	●
TM-4RP-D25.0R2.0	25.0	2.0	25	24.0	45	75	150	4	●
TM-4RP-D25.0R3.0	25.0	3.0	25	24.0	45	75	150	4	●
TM-4RP-D25.0R4.0	25.0	4.0	25	24.0	45	75	150	4	●
TM-4RP-D25.0R5.0	25.0	5.0	25	24.0	45	75	150	4	●

● Stock available ○ Make-to-order

Applicable workpiece material table ○ Very suitable ○ Suitable

Workpiece material											
Carbon steel	Alloy steel	Pre-hardened steel, Hardened steel				Stainless steel	Cast iron, Nodular cast iron	Copper alloy	Aluminum alloy	Titanium alloy	Heat resistant alloy
		~40HRC	~50HRC	~55HRC	~68HRC						
○	○					○				○	○

Code key

B258

Graphics category and identification

B259

Cutting parameters

B540

Non-standard customization

B570-B571

TM series for titanium alloy machining

5-flute R end mills with straight shank



TM-5R

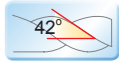
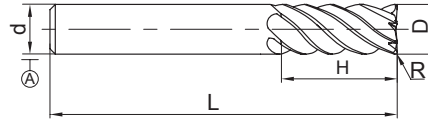

Type	Basic dimension(mm)					Number of teeth Z	Stock
	D	R	d	H	L		
TM-5R-D6.0R0.2	6.0	0.2	6	16	50	5	○
TM-5R-D6.0R0.3	6.0	0.3	6	16	50	5	○
TM-5R-D6.0R0.5	6.0	0.5	6	16	50	5	○
TM-5R-D6.0R0.75	6.0	0.75	6	16	50	5	○
TM-5R-D6.0R1.0	6.0	1.0	6	16	50	5	○
TM-5R-D8.0R0.2	8.0	0.2	8	20	60	5	○
TM-5R-D8.0R0.3	8.0	0.3	8	20	60	5	○
TM-5R-D8.0R0.5	8.0	0.5	8	20	60	5	○
TM-5R-D8.0R0.75	8.0	0.75	8	20	60	5	○
TM-5R-D8.0R1.0	8.0	1.0	8	20	60	5	○
TM-5R-D8.0R2.0	8.0	2.0	8	20	60	5	○
TM-5R-D10.0R0.2	10.0	0.2	10	25	75	5	○
TM-5R-D10.0R0.3	10.0	0.3	10	25	75	5	○
TM-5R-D10.0R0.5	10.0	0.5	10	25	75	5	○
TM-5R-D10.0R0.75	10.0	0.75	10	25	75	5	○
TM-5R-D10.0R1.0	10.0	1.0	10	25	75	5	○
TM-5R-D10.0R1.5	10.0	1.5	10	25	75	5	○
TM-5R-D10.0R2.0	10.0	2.0	10	25	75	5	○
TM-5R-D12.0R0.2	12.0	0.2	12	30	75	5	○
TM-5R-D12.0R0.3	12.0	0.3	12	30	75	5	○
TM-5R-D12.0R0.5	12.0	0.5	12	30	75	5	○
TM-5R-D12.0R0.75	12.0	0.75	12	30	75	5	○
TM-5R-D12.0R1.0	12.0	1.0	12	30	75	5	○
TM-5R-D12.0R1.5	12.0	1.5	12	30	75	5	○
TM-5R-D12.0R2.0	12.0	2.0	12	30	75	5	○
TM-5R-D12.0R2.5	12.0	2.5	12	30	75	5	○
TM-5R-D12.0R3.0	12.0	3.0	12	30	75	5	○
TM-5R-D14.0R0.2	14.0	0.2	14	35	90	5	○
TM-5R-D14.0R0.3	14.0	0.3	14	35	90	5	○
TM-5R-D14.0R0.5	14.0	0.5	14	35	90	5	○
TM-5R-D14.0R0.75	14.0	0.75	14	35	90	5	○

Applicable workpiece material table ○ Very suitable ○ Suitable

● Stock available ○ Make-to-order

Workpiece material											
Carbon steel	Alloy steel	Pre-hardened steel, Hardened steel				Stainless steel	Cast iron, Nodular cast iron	Copper alloy	Aluminum alloy	Titanium alloy	Heat resistant alloy
		~40HRC	~50HRC	~55HRC	~68HRC						
○	○					○				○	○

Code key

B258

Graphics category and identification

B259

Cutting parameters

B542

Non-standard customization

B570-B571

Indexable milling tools
Solid carbide end mills
TM series



MILLING Solid Carbide End Mills

TM series for titanium alloy machining

5-flute R end mills with straight shank



Radius shoulder

Profile

Radius corner slot

TM-5R

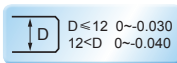
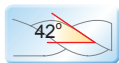
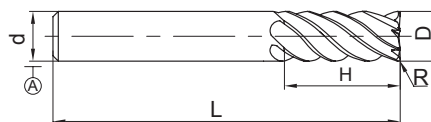

Type	Basic dimension(mm)					Number of teeth Z	Stock
	D	R	d	H	L		
TM-5R-D14.0R1.0	14.0	1.0	14	35	90	5	○
TM-5R-D14.0R1.5	14.0	1.5	14	35	90	5	○
TM-5R-D14.0R2.0	14.0	2.0	14	35	90	5	○
TM-5R-D14.0R2.5	14.0	2.5	14	35	90	5	○
TM-5R-D14.0R3.0	14.0	3.0	14	35	90	5	○
TM-5R-D16.0R0.2	16.0	0.2	16	35	90	5	○
TM-5R-D16.0R0.3	16.0	0.3	16	35	90	5	○
TM-5R-D16.0R0.5	16.0	0.5	16	35	90	5	○
TM-5R-D16.0R0.75	16.0	0.75	16	35	90	5	○
TM-5R-D16.0R1.0	16.0	1.0	16	35	90	5	○
TM-5R-D16.0R1.5	16.0	1.5	16	35	90	5	○
TM-5R-D16.0R2.0	16.0	2.0	16	35	90	5	○
TM-5R-D16.0R2.5	16.0	2.5	16	35	90	5	○
TM-5R-D16.0R3.0	16.0	3.0	16	35	90	5	○
TM-5R-D16.0R4.0	16.0	4.0	16	35	90	5	○
TM-5R-D20.0R0.2	20.0	0.2	20	45	100	5	○
TM-5R-D20.0R0.3	20.0	0.3	20	45	100	5	○
TM-5R-D20.0R0.5	20.0	0.5	20	45	100	5	○
TM-5R-D20.0R0.75	20.0	0.75	20	45	100	5	○
TM-5R-D20.0R1.0	20.0	1.0	20	45	100	5	○
TM-5R-D20.0R1.5	20.0	1.5	20	45	100	5	○
TM-5R-D20.0R2.0	20.0	2.0	20	45	100	5	○
TM-5R-D20.0R2.5	20.0	2.5	20	45	100	5	○
TM-5R-D20.0R3.0	20.0	3.0	20	45	100	5	○
TM-5R-D20.0R4.0	20.0	4.0	20	45	100	5	○
TM-5R-D25.0R1.0	25.0	1.0	25	50	110	5	○
TM-5R-D25.0R2.0	25.0	2.0	25	50	110	5	○
TM-5R-D25.0R3.0	25.0	3.0	25	50	110	5	○
TM-5R-D25.0R4.0	25.0	4.0	25	50	110	5	○
TM-5R-D25.0R5.0	25.0	5.0	25	50	110	5	○

● Stock available ○ Make-to-order

Applicable workpiece material

Carbon steel	Alloy steel	Pre-hardened steel, Hardened steel				Stainless steel	Cast iron, Nodular cast iron	Copper alloy	Aluminum alloy	Titanium alloy	Heat resistant alloy
		~40HRC	~50HRC	~55HRC	~68HRC						
○	○					○				○	○

Code key

B258

Graphics category and identification

B259

Cutting parameters

B542

Non-standard customization

B570-B571

TM series for titanium alloy machining

6-flute R end mills with straight shank



TM-6R

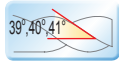
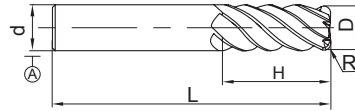

Type	Basic dimension(mm)					Number of teeth Z	Stock
	D	R	d	H	L		
TM-6R-D10.0R1.0	10.0	1.0	10	25	75	6	○
TM-6R-D10.0R2.0	10.0	2.0	10	25	75	6	○
TM-6R-D12.0R1.0	12.0	1.0	12	30	75	6	○
TM-6R-D12.0R2.0	12.0	2.0	12	30	75	6	○
TM-6R-D12.0R3.0	12.0	3.0	12	30	75	6	○
TM-6R-D14.0R1.0	14.0	1.0	14	35	90	6	○
TM-6R-D14.0R2.0	14.0	2.0	14	35	90	6	○
TM-6R-D14.0R3.0	14.0	3.0	14	35	90	6	○
TM-6R-D16.0R1.0	16.0	1.0	16	35	90	6	○
TM-6R-D16.0R2.5	16.0	2.5	16	35	90	6	○
TM-6R-D16.0R4.0	16.0	4.0	16	35	90	6	○
TM-6R-D20.0R1.0	20.0	1.0	20	45	100	6	○
TM-6R-D20.0R2.5	20.0	2.5	20	45	100	6	○
TM-6R-D20.0R4.0	20.0	4.0	20	45	100	6	○
TM-6R-D25.0R1.0	25.0	1.0	25	50	110	6	○
TM-6R-D25.0R2.5	25.0	2.5	25	50	110	6	○
TM-6R-D25.0R4.0	25.0	4.0	25	50	110	6	○

● Stock available ○ Make-to-order

Indexable milling tools

Solid carbide end mills

TM series

Applicable workpiece material table ○Very suitable ○Suitable

Workpiece material											
Carbon steel	Alloy steel	Pre-hardened steel, Hardened steel				Stainless steel	Cast iron, Nodular cast iron	Copper alloy	Aluminum alloy	Titanium alloy	Heat resistant alloy
		~40HRC	~50HRC	~55HRC	~68HRC						
○	○					○				○	○



NM series for copper machining

Outstanding NM milling series, let copper&alloys of copper machining wonderful!

- With super sharp edge, most suitable for high precision machining of copper&alloy of copper.
- With CrN coating which own good lubricating property and small friction coefficient, can realize light cutting processing circle, long tool life and high quality machined surface.

Coat	Hardness(HV)	Friction coefficient	Oxidizing temperature(C°)	Strengthness combined with substrate
CrN	1800	0.25	700	⊙
TiN	2200	0.4	500	⊙
TiCN	2700	0.3	400	○
TiAlN	2800	0.3	800	⊙

⊙ Excellent ○ Normal

Tool: NM-2B-R3.0
 Dimension: R3.0mm
 workpiece material: C1100
 Rotating speed: 8000r/min (150m/min)
 Feed speed: 1200mm/min (0.15mm/r)
 Axial cutting depth: $a_p=0.3\text{mm}$
 Radial cutting depth: $a_e=0.6\text{mm}$
 Cutting style: face milling(down milling) Cooling system : air cooling
 Machine: MIKRON UCP 1000

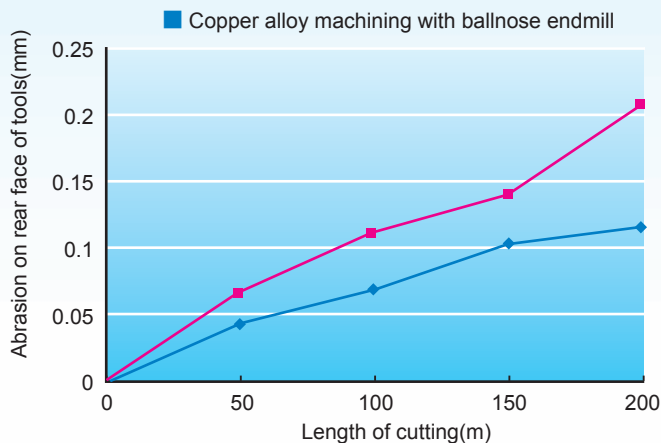
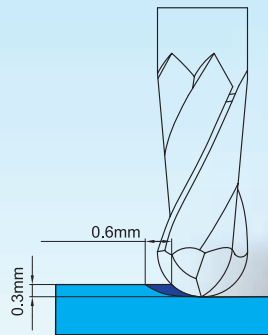

NM series for copper machining

2-flute flattened end mills with straight shank



NM-2E



- Very suitable for slotting.
- Sharp edge, can realize high quality surface.

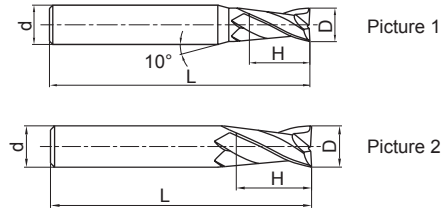

Type	Basic dimension(mm)				Number of teeth Z	Geometry	Stock
	D	d	H	L			
NM-2E-D1.0	1.0	4	3	50	2	Picture 1	○
NM-2E-D2.0	2.0	4	6	50	2	Picture 1	○
NM-2E-D3.0	3.0	6	8	50	2	Picture 1	○
NM-2E-D4.0	4.0	6	11	50	2	Picture 1	○
NM-2E-D5.0	5.0	6	13	50	2	Picture 1	○
NM-2E-D6.0	6.0	6	16	50	2	Picture 2	○
NM-2E-D8.0	8.0	8	20	60	2	Picture 2	○
NM-2E-D10.0	10.0	10	25	75	2	Picture 2	○
NM-2E-D12.0	12.0	12	30	75	2	Picture 2	○

● Stock available ○ Make-to-order

Indexable milling tools
Solid carbide end mills
NM series

➤ Applicable workpiece material table ○ Very suitable ○ Suitable

Workpiece material											
Carbon steel	Alloy steel	Pre-hardened steel, Hardened steel				Stainless steel	Cast iron, Nodular cast iron	Copper alloy	Aluminum alloy	Titanium alloy	Heat resistant alloy
		~40HRC	~50HRC	~55HRC	~68HRC						
							○	○			



NM series for copper machining

4-flute flattened end mills with straight shank



NM-4E

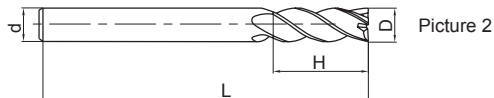
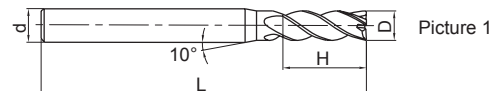

- Very suitable for slotting.
- Sharp edge, can realize high quality surface.

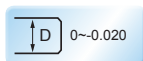
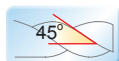

Type	Basic dimension(mm)				Number of teeth Z	Geometry	Stock
	D	d	H	L			
NM-4E-D3.0	3.0	6	8	50	4	Picture 1	○
NM-4E-D4.0	4.0	6	11	50	4	Picture 1	○
NM-4E-D5.0	5.0	6	13	50	4	Picture 1	○
NM-4E-D6.0	6.0	6	16	50	4	Picture 2	○
NM-4E-D8.0	8.0	8	20	60	4	Picture 2	○
NM-4E-D10.0	10.0	10	25	75	4	Picture 2	○
NM-4E-D12.0	12.0	12	30	75	4	Picture 2	○

● Stock available ○ Make-to-order

Indexable milling tools

Solid carbide end mills

NM series

Applicable workpiece material table ○Very suitable ○Suitable

Workpiece material											
Carbon steel	Alloy steel	Pre-hardened steel、Hardened steel				Stainless steel	Cast iron, Nodular cast iron	Copper alloy	Aluminum alloy	Titanium alloy	Heat resistant alloy
		~40HRC	~50HRC	~55HRC	~68HRC						
							●	○			

Code key

B258

Graphics category and identification

B259

Cutting parameters

B545

Non-standard customization

B570-B571

2-flute flattened end mills with straight shank, long neck and short cutting edge



Deep flattened slot

NM-2EP

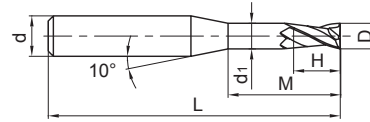

- Suitable for profile milling.
- Workpiece surface is excellent after machining.

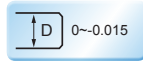
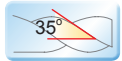

Type	Basic dimension(mm)						Number of teeth Z	Stock
	D	d	H	M	d ₁	L		
NM-2EP-D0.5-M04	0.5	4	0.7	4	0.45	50	2	○
NM-2EP-D0.5-M06	0.5	4	0.7	6	0.45	50	2	○
NM-2EP-D0.5-M08	0.5	4	0.7	8	0.45	50	2	○
NM-2EP-D0.8-M04	0.8	4	1.2	4	0.75	50	2	○
NM-2EP-D0.8-M06	0.8	4	1.2	6	0.75	50	2	○
NM-2EP-D0.8-M08	0.8	4	1.2	8	0.75	50	2	○
NM-2EP-D0.8-M10	0.8	4	1.2	10	0.75	50	2	○
NM-2EP-D1.0-M04	1.0	4	1.5	4	0.95	50	2	○
NM-2EP-D1.0-M06	1.0	4	1.5	6	0.95	50	2	○
NM-2EP-D1.0-M08	1.0	4	1.5	8	0.95	50	2	○
NM-2EP-D1.0-M10	1.0	4	1.5	10	0.95	50	2	○
NM-2EP-D1.0-M12	1.0	4	1.5	12	0.95	50	2	○
NM-2EP-D1.0-M14	1.0	4	1.5	14	0.95	50	2	○
NM-2EP-D1.5-M08	1.5	4	2.3	8	1.45	50	2	○
NM-2EP-D1.5-M16	1.5	4	2.3	16	1.45	50	2	○
NM-2EP-D2.0-M06	2.0	4	3.0	6	1.95	50	2	○
NM-2EP-D2.0-M08	2.0	4	3.0	8	1.95	50	2	○
NM-2EP-D2.0-M10	2.0	4	3.0	10	1.95	50	2	○
NM-2EP-D2.0-M12	2.0	4	3.0	12	1.95	50	2	○
NM-2EP-D2.0-M14	2.0	4	3.0	14	1.95	50	2	○
NM-2EP-D2.0-M16	2.0	4	3.0	16	1.95	50	2	○
NM-2EP-D2.5-M10	2.5	4	3.7	10	2.4	50	2	○
NM-2EP-D2.5-M20	2.5	4	3.7	20	2.4	60	2	○
NM-2EP-D3.0-M10	3.0	6	4.5	10	2.85	50	2	○
NM-2EP-D3.0-M20	3.0	6	4.5	20	2.85	60	2	○
NM-2EP-D4.0-M16	4.0	6	6.0	16	3.85	60	2	○
NM-2EP-D4.0-M25	4.0	6	6.0	25	3.85	60	2	○
NM-2EP-D5.0-M16	5.0	6	7.5	16	4.85	60	2	○
NM-2EP-D5.0-M25	5.0	6	7.5	25	4.85	70	2	○

Applicable workpiece material table ● Very suitable ○ Suitable

● Stock available ○ Make-to-order

Workpiece material											
Carbon steel	Alloy steel	Pre-hardened steel, Hardened steel				Stainless steel	Cast iron, Nodular cast iron	Copper alloy	Aluminum alloy	Titanium alloy	Heat resistant alloy
		~40HRC	~50HRC	~55HRC	~68HRC						
							●	○			

Code key

B258

Graphics category and identification

B259

Cutting parameters

B546

Non-standard customization

B570-B571

NM series for copper machining

2-flute ball nose end mills with straight shank



NM-2B



- Suitable for profile milling.
- Workpiece surface is excellent after machining.

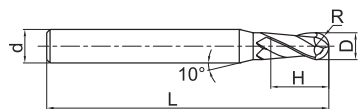
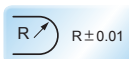
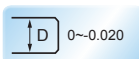
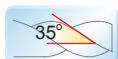

Picture 1

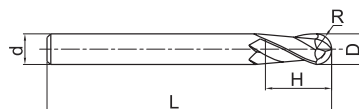

Picture 2

Type	Basic dimension(mm)					Number of teeth Z	Geometry	Stock
	D	R	d	H	L			
NM-2B-R0.5	1.0	0.5	4	2	50	2	Picture 1	○
NM-2B-R0.75	1.5	0.75	4	3	50	2	Picture 1	○
NM-2B-R1.0	2.0	1.0	4	4	50	2	Picture 1	○
NM-2B-R1.25	2.5	1.25	4	5	50	2	Picture 1	○
NM-2B-R1.5	3.0	1.5	6	6	50	2	Picture 1	○
NM-2B-R1.75	3.5	1.75	6	8	50	2	Picture 1	○
NM-2B-R2.0	4.0	2.0	6	8	50	2	Picture 1	○
NM-2B-R2.5	5.0	2.5	6	10	50	2	Picture 1	○
NM-2B-R3.0	6.0	3.0	6	12	50	2	Picture 2	○
NM-2B-R4.0	8.0	4.0	8	16	60	2	Picture 2	○
NM-2B-R5.0	10.0	5.0	10	20	75	2	Picture 2	○
NM-2B-R6.0	12.0	6.0	12	24	75	2	Picture 2	○

● Stock available ○ Make-to-order

Indexable milling tools

Solid carbide end mills

NM series

Applicable workpiece material table ○Very suitable ○Suitable

Workpiece material											
Carbon steel	Alloy steel	Pre-hardened steel, Hardened steel				Stainless steel	Cast iron, Nodular cast iron	Copper alloy	Aluminum alloy	Titanium alloy	Heat resistant alloy
		~40HRC	~50HRC	~55HRC	~68HRC						
							○	○			

Code key

B258

Graphics category and identification

B259

Cutting parameters

B547

Non-standard customization

B570-B571

2-flute ball nose end mills with straight shank, long neck and short cutting edge



NM-2BP

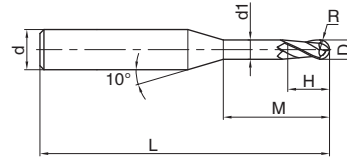

● Very suitable for copper electrode three dimensional machining.

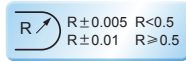
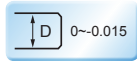
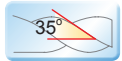

Type	Basic dimension(mm)							Number of teeth Z	Stock
	D	R	H	d ₁	M	d	L		
NM-2BP-R0.25-M04	0.5	0.25	0.7	0.45	4	4	50	2	○
NM-2BP-R0.25-M06	0.5	0.25	0.7	0.45	6	4	50	2	○
NM-2BP-R0.3-M04	0.6	0.3	0.9	0.55	4	4	50	2	○
NM-2BP-R0.3-M06	0.6	0.3	0.9	0.55	6	4	50	2	○
NM-2BP-R0.3-M08	0.6	0.3	0.9	0.55	8	4	50	2	○
NM-2BP-R0.4-M04	0.8	0.4	1.2	0.75	4	4	50	2	○
NM-2BP-R0.4-M06	0.8	0.4	1.2	0.75	6	4	50	2	○
NM-2BP-R0.4-M08	0.8	0.4	1.2	0.75	8	4	50	2	○
NM-2BP-R0.4-M10	0.8	0.4	1.2	0.75	10	4	50	2	○
NM-2BP-R0.5-M04	1.0	0.5	1.5	0.95	4	4	50	2	○
NM-2BP-R0.5-M06	1.0	0.5	1.5	0.95	6	4	50	2	○
NM-2BP-R0.5-M08	1.0	0.5	1.5	0.95	8	4	50	2	○
NM-2BP-R0.5-M10	1.0	0.5	1.5	0.95	10	4	50	2	○
NM-2BP-R0.5-M12	1.0	0.5	1.5	0.95	12	4	50	2	○
NM-2BP-R0.75-M08	1.5	0.75	2.3	1.45	8	4	50	2	○
NM-2BP-R0.75-M16	1.5	0.75	2.3	1.45	16	4	50	2	○
NM-2BP-R1.0-M06	2.0	1.0	3.0	1.95	6	4	50	2	○
NM-2BP-R1.0-M08	2.0	1.0	3.0	1.95	8	4	50	2	○
NM-2BP-R1.0-M10	2.0	1.0	3.0	1.95	10	4	50	2	○
NM-2BP-R1.0-M12	2.0	1.0	3.0	1.95	12	4	50	2	○
NM-2BP-R1.0-M16	2.0	1.0	3.0	1.95	16	4	50	2	○
NM-2BP-R1.0-M20	2.0	1.0	3.0	1.95	20	4	60	2	○
NM-2BP-R1.5-M10	3.0	1.5	4.5	2.85	10	6	50	2	○
NM-2BP-R1.5-M20	3.0	1.5	4.5	2.85	20	6	60	2	○
NM-2BP-R2.0-M10	4.0	2.0	6.0	3.85	10	6	60	2	○
NM-2BP-R2.0-M16	4.0	2.0	6.0	3.85	16	6	60	2	○
NM-2BP-R2.0-M20	4.0	2.0	6.0	3.85	20	6	60	2	○
NM-2BP-R2.0-M25	4.0	2.0	6.0	3.85	25	6	60	2	○
NM-2BP-R2.5-M16	5.0	2.5	7.5	4.85	16	6	60	2	○
NM-2BP-R2.5-M25	5.0	2.5	7.5	4.85	25	6	70	2	○

● Stock available ○ Make-to-order

Applicable workpiece material table ● Very suitable ○ Suitable

Workpiece material											
Carbon steel	Alloy steel	Pre-hardened steel, Hardened steel				Stainless steel	Cast iron, Nodular cast iron	Copper alloy	Aluminum alloy	Titanium alloy	Heat resistant alloy
		~40HRC	~50HRC	~55HRC	~68HRC						
								●	○		

Code key

B258

Graphics category and identification

B259

Cutting parameters

B548

Non-standard customization

B570-B571

Indexable milling tools
Solid carbide end mills
NM series

AL

series end mills for Al machining

● Chip pocket with unique shape exerts excellent performances even in slot and cavity machining.

● Sharp cutting edge and large helical angle design effectively prevent built-up edge.

● Anti-vibration design of whole edge can suppress the chattering during machining and improve surface quality.

Tool type: AL-3E-D6.0
Dimensions: $\varnothing 6.0\text{mm}$
Workpiece material: LC4
Rotating speed: 13000r/min (250m/min)
Feed speed: 1950mm/min (0.15mm/r)
Axial cutting depth: $a_p=9.0\text{mm}$
Radial cutting depth: $a_e=1.0\text{mm}$
Cutting style: Complicated cavity machining
Cooling system: air blow
Machine tool: MIKRON UCP 1000

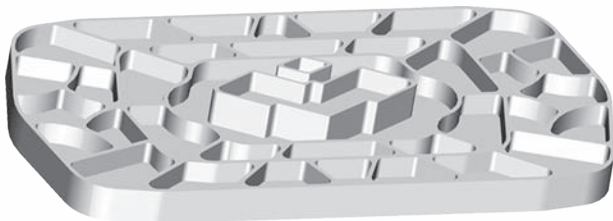

Even the complicated machining of thin-wall cavity parts can be achieved easily.



2-flute flattened end mills with straight shank



AL-2E

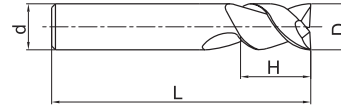
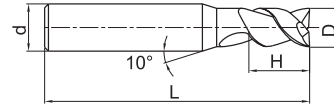

● Good chip removal performance, high machining efficiency.

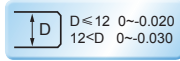
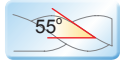

Type	Basic dimension(mm)				Number of teeth Z	Geometry	Stock
	D	d	H	L			
AL-2E-D1.0	1.0	4	3	50	2	Picture 1	●
AL-2E-D1.5	1.5	4	4	50	2	Picture 1	●
AL-2E-D2.0	2.0	4	6	50	2	Picture 1	●
AL-2E-D2.5	2.5	4	7	50	2	Picture 1	●
AL-2E-D3.0	3.0	6	9	50	2	Picture 1	●
AL-2E-D4.0	4.0	6	12	50	2	Picture 1	●
AL-2E-D5.0	5.0	6	15	50	2	Picture 1	●
AL-2E-D6.0	6.0	6	18	60	2	Picture 2	●
AL-2E-D8.0	8.0	8	20	60	2	Picture 2	●
AL-2E-D10.0	10.0	10	30	75	2	Picture 2	●
AL-2E-D12.0	12.0	12	32	75	2	Picture 2	●
AL-2E-D16.0	16.0	16	45	100	2	Picture 2	●
AL-2E-D20.0	20.0	20	45	100	2	Picture 2	●

● Stock available ○ Make-to-order

Indexable milling tools

Solid carbide end mills

AL series

Applicable workpiece material table ○ Very suitable ○ Suitable

Workpiece material											
Carbon steel	Alloy steel	Pre-hardened steel, Hardened steel				Stainless steel	Cast iron, Nodular cast iron	Copper alloy	Aluminum alloy	Titanium alloy	Heat resistant alloy
		~40HRC	~50HRC	~55HRC	~68HRC						
								○			

Code key **B258**

Graphics category and identification **B259**

Cutting parameters **B549**

Non-standard customization **B570-B571**

AL/ALG series for machining aluminum

2-flute flattened end mills with straight shank and long cutting edge



AL-2EL

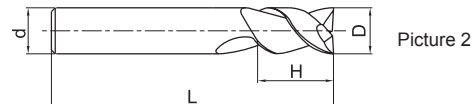
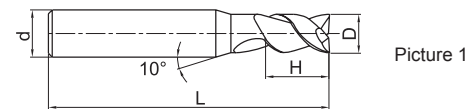

● AL-2E series with long cutting edge.

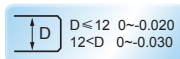
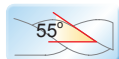

Type	Basic dimension(mm)				Number of teeth Z	Geometry	Stock
	D	d	H	L			
AL-2EL-D3.0	3.0	6	12	60	2	Picture 1	●
AL-2EL-D4.0	4.0	6	16	60	2	Picture 1	●
AL-2EL-D5.0	5.0	6	20	60	2	Picture 1	●
AL-2EL-D6.0	6.0	6	25	75	2	Picture 2	●
AL-2EL-D8.0	8.0	8	32	75	2	Picture 2	●
AL-2EL-D10.0	10.0	10	45	100	2	Picture 2	●
AL-2EL-D12.0	12.0	12	45	100	2	Picture 2	●
AL-2EL-D16.0	16.0	16	65	150	2	Picture 2	●
AL-2EL-D20.0	20.0	20	75	150	2	Picture 2	●

● Stock available ○ Make-to-order

Indexable
milling tools

Solid carbide
end mills

AL series

Applicable workpiece material table ○ Very suitable ○ Suitable

Workpiece material											
Carbon steel	Alloy steel	Pre-hardened steel, Hardened steel				Stainless steel	Cast iron, Nodular cast iron	Copper alloy	Aluminum alloy	Titanium alloy	Heat resistant alloy
		~40HRC	~50HRC	~55HRC	~68HRC						
								○			

Code key

B258

Graphics category and identification

B259

Cutting parameters

B549

Non-standard customization

B570-B571

3-flute flattened end mills with straight shank



AL-3E



- Outstanding cutting performance with no chattering, achieving high-precision machining.

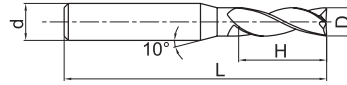
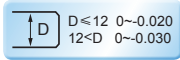
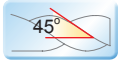

Picture 1

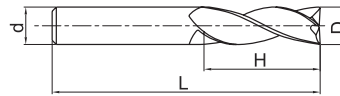

Picture 2

Type	Basic dimension(mm)				Number of teeth Z	Geometry	Stock
	D	d	H	L			
AL-3E-D1.0	1.0	4	3	50	3	Picture 1	●
AL-3E-D1.5	1.5	4	4	50	3	Picture 1	●
AL-3E-D2.0	2.0	4	6	50	3	Picture 1	●
AL-3E-D2.5	2.5	4	7	50	3	Picture 1	●
AL-3E-D3.0	3.0	6	9	50	3	Picture 1	●
AL-3E-D4.0	4.0	6	12	50	3	Picture 1	●
AL-3E-D5.0	5.0	6	15	50	3	Picture 1	●
AL-3E-D6.0	6.0	6	18	60	3	Picture 2	●
AL-3E-D8.0	8.0	8	20	60	3	Picture 2	●
AL-3E-D10.0	10.0	10	30	75	3	Picture 2	●
AL-3E-D12.0	12.0	12	32	75	3	Picture 2	●
AL-3E-D16.0	16.0	16	45	100	3	Picture 2	●
AL-3E-D20.0	20.0	20	45	100	3	Picture 2	●

● Stock available ○ Make-to-order

Indexable milling tools
Solid carbide end mills
AL series

Applicable workpiece material table ○ Very suitable ○ Suitable

Workpiece material											
Carbon steel	Alloy steel	Pre-hardened steel, Hardened steel				Stainless steel	Cast iron, Nodular cast iron	Copper alloy	Aluminum alloy	Titanium alloy	Heat resistant alloy
		~40HRC	~50HRC	~55HRC	~68HRC						
								○			



AL/ALG series for machining aluminum

3-flute flattened end mills with straight shank and long cutting edge



AL-3EL

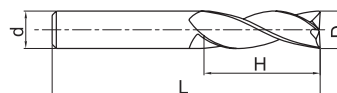
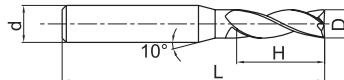

● AL-3E series with long cutting edge.

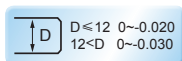
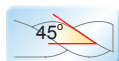

Type	Basic dimension(mm)				Number of teeth Z	Geometry	Stock
	D	d	H	L			
AL-3EL-D3.0	3.0	6	12	60	3	Picture 1	●
AL-3EL-D4.0	4.0	6	16	60	3	Picture 1	●
AL-3EL-D5.0	5.0	6	20	60	3	Picture 1	●
AL-3EL-D6.0	6.0	6	25	75	3	Picture 2	●
AL-3EL-D8.0	8.0	8	32	75	3	Picture 2	●
AL-3EL-D10.0	10.0	10	45	100	3	Picture 2	●
AL-3EL-D12.0	12.0	12	45	100	3	Picture 2	●
AL-3EL-D16.0	16.0	16	65	150	3	Picture 2	●
AL-3EL-D20.0	20.0	20	75	150	3	Picture 2	●

● Stock available ○ Make-to-order

Indexable milling tools

Solid carbide end mills

AL series

➤ Applicable workpiece material table ○Very suitable ○Suitable

Workpiece material											
Carbon steel	Alloy steel	Pre-hardened steel, Hardened steel				Stainless steel	Cast iron, Nodular cast iron	Copper alloy	Aluminum alloy	Titanium alloy	Heat resistant alloy
		~40HRC	~50HRC	~55HRC	~68HRC						
								○			

Code key

B258

Graphics category and identification

B259

Cutting parameters

B550

Non-standard customization

B570-B571

2-flute ball nose end mills with straight shank



AL-2B

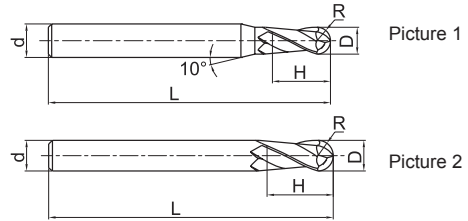

● Suitable for profile milling aluminum alloy.

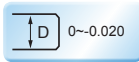
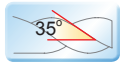

Type	Basic dimension(mm)					Number of teeth Z	Geometry	Stock
	D	R	d	H	L			
AL-2B-R1.0	2.0	1.0	6	4	60	2	Picture 1	●
AL-2B-R1.5	3.0	1.5	6	6	60	2	Picture 1	●
AL-2B-R2.0	4.0	2.0	6	8	60	2	Picture 1	●
AL-2B-R2.5	5.0	2.5	6	10	60	2	Picture 1	●
AL-2B-R3.0	6.0	3.0	6	12	60	2	Picture 2	●
AL-2B-R4.0	8.0	4.0	8	16	75	2	Picture 2	●
AL-2B-R5.0	10.0	5.0	10	20	75	2	Picture 2	●
AL-2B-R6.0	12.0	6.0	12	24	75	2	Picture 2	●

● Stock available ○ Make-to-order

Indexable milling tools

Solid carbide end mills

AL series

➤ Applicable workpiece material table ○Very suitable ○Suitable

Workpiece material											
Carbon steel	Alloy steel	Pre-hardened steel, Hardened steel				Stainless steel	Cast iron, Nodular cast iron	Copper alloy	Aluminum alloy	Titanium alloy	Heat resistant alloy
		~40HRC	~50HRC	~55HRC	~68HRC						
								○			

Code key **B258**

Graphics category and identification **B259**

Cutting parameters **B551**

Non-standard customization **B570-B571**

3-flute flattened end mills with straight shank and corrugated edges



AL-3W

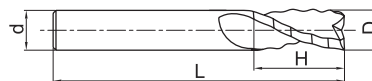

● For rough machining of Al alloy.

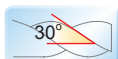

D ≤ 6	0 ~ -0.048	6 < D ≤ 10	0 ~ -0.058
10 < D ≤ 18	0 ~ -0.07	18 < D	0 ~ -0.084



Type	Basic dimension(mm)				Number of teeth Z	Stock
	D	d	H	L		
AL-3W-D6.0	6.0	6	16	50	3	●
AL-3W-D8.0	8.0	8	20	60	3	●
AL-3W-D10.0	10.0	10	25	75	3	●
AL-3W-D12.0	12.0	12	30	75	3	●
AL-3W-D16.0	16.0	16	45	100	3	●
AL-3W-D20.0	20.0	20	45	100	3	●

● Stock available ○ Make-to-order

Indexable
milling tools

Solid carbide
end mills

AL series

Applicable workpiece material table ○Very suitable ○Suitable

Workpiece material											
Carbon steel	Alloy steel	Pre-hardened steel, Hardened steel				Stainless steel	Cast iron, Nodular cast iron	Copper alloy	Aluminum alloy	Titanium alloy	Heat resistant alloy
		~40HRC	~50HRC	~55HRC	~68HRC						
									○		

Code key

B258

Graphics category and identification

B259

Cutting parameters

B552

Non-standard customization

B570-B571

2-flute R end mills with straight shank



super high speed

AL-2R-AIR

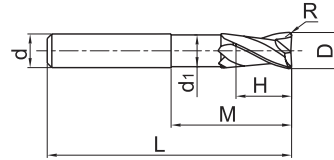

Very suitable for super high speed milling of Al workpiece.

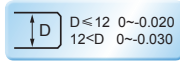
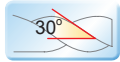

Type	Basic dimension(mm)							Number of teeth Z	Stock
	D	R	d	d ₁	H	M	L		
AL-2R-D6.0R1.0- AIR	6.0	1.0	6	5.5	7	20	57	2	○
AL-2R-D8.0R1.0- AIR	8.0	1.0	8	7.4	9	26	63	2	○
AL-2R-D10.0R1.0- AIR	10.0	1.0	10	9.2	11	31	72	2	○
AL-2R-D10.0R2.0- AIR	10.0	2.0	10	9.2	11	31	72	2	○
AL-2R-D12.0R1.0- AIR	12.0	1.0	12	11.0	12	37	83	2	○
AL-2R-D12.0R2.0- AIR	12.0	2.0	12	11.0	12	37	83	2	○
AL-2R-D12.0R3.0- AIR	12.0	3.0	12	11.0	12	37	83	2	○
AL-2R-D16.0R1.0- AIR	16.0	1.0	16	15.0	16	43	92	2	○
AL-2R-D16.0R2.0- AIR	16.0	2.0	16	15.0	16	43	92	2	○
AL-2R-D16.0R3.0- AIR	16.0	3.0	16	15.0	16	43	92	2	○
AL-2R-D16.0R4.0- AIR	16.0	4.0	16	15.0	16	43	92	2	○
AL-2R-D20.0R1.0- AIR	20.0	1.0	20	19.0	20	53	104	2	○
AL-2R-D20.0R2.0- AIR	20.0	2.0	20	19.0	20	53	104	2	○
AL-2R-D20.0R3.0- AIR	20.0	3.0	20	19.0	20	53	104	2	○
AL-2R-D20.0R4.0- AIR	20.0	4.0	20	19.0	20	53	104	2	○
AL-2R-D20.0R5.0- AIR	20.0	5.0	20	19.0	20	53	104	2	○
AL-2R-D20.0R6.0- AIR	20.0	6.0	20	19.0	20	53	104	2	○

● Stock available ○ Make-to-order

Indexable milling tools
Solid carbide end mills
AL series

Applicable workpiece material table ● Very suitable ○ Suitable

Workpiece material											
Carbon steel	Alloy steel	Pre-hardened steel, Hardened steel				Stainless steel	Cast iron, Nodular cast iron	Copper alloy	Aluminum alloy	Titanium alloy	Heat resistant alloy
		~40HRC	~50HRC	~55HRC	~68HRC						
									●		



2-flute R end mills with straight and long shank



super high speed AL-2RL-AIR

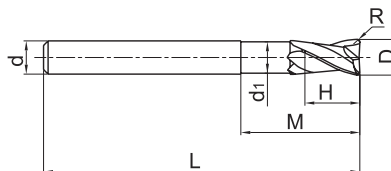

- Very suitable for super high speed milling of Al workpiece.

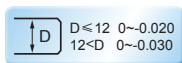
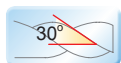

Type	Basic dimension(mm)							Number of teeth Z	Stock
	D	R	d	d ₁	H	M	L		
AL-2RL-D6.0R1.0- AIR	6.0	1.0	6	5.5	7	43	80	2	○
AL-2RL-D8.0R1.0- AIR	8.0	1.0	8	7.4	9	53	90	2	○
AL-2RL-D10.0R1.0- AIR	10.0	1.0	10	9.2	11	59	100	2	○
AL-2RL-D10.0R2.0- AIR	10.0	2.0	10	9.2	11	59	100	2	○
AL-2RL-D12.0R1.0- AIR	12.0	1.0	12	11.0	12	74	120	2	○
AL-2RL-D12.0R2.0- AIR	12.0	2.0	12	11.0	12	74	120	2	○
AL-2RL-D12.0R3.0- AIR	12.0	3.0	12	11.0	12	74	120	2	○
AL-2RL-D16.0R1.0- AIR	16.0	1.0	16	15.0	16	84	140	2	○
AL-2RL-D16.0R2.0- AIR	16.0	2.0	16	15.0	16	84	140	2	○
AL-2RL-D16.0R3.0- AIR	16.0	3.0	16	15.0	16	84	140	2	○
AL-2RL-D16.0R4.0- AIR	16.0	4.0	16	15.0	16	84	140	2	○
AL-2RL-D20.0R1.0- AIR	20.0	1.0	20	19.0	20	89	140	2	○
AL-2RL-D20.0R2.0- AIR	20.0	2.0	20	19.0	20	89	140	2	○
AL-2RL-D20.0R3.0- AIR	20.0	3.0	20	19.0	20	89	140	2	○
AL-2RL-D20.0R4.0- AIR	20.0	4.0	20	19.0	20	89	140	2	○
AL-2RL-D20.0R5.0- AIR	20.0	5.0	20	19.0	20	89	140	2	○
AL-2RL-D20.0R6.0- AIR	20.0	6.0	20	19.0	20	89	140	2	○

● Stock available ○ Make-to-order

Indexable milling tools

Solid carbide end mills

AL series

Applicable workpiece material table ●Very suitable ○Suitable

Workpiece material											
Carbon steel	Alloy steel	Pre-hardened steel, Hardened steel				Stainless steel	Cast iron, Nodular cast iron	Copper alloy	Aluminum alloy	Titanium alloy	Heat resistant alloy
		~40HRC	~50HRC	~55HRC	~68HRC						
								●			

Code key

B258

Graphics category and identification

B259

Cutting parameters

B553

Non-standard customization

B570-B571

3-flute R end mills with straight shank



super high speed

AL-3R-AIR

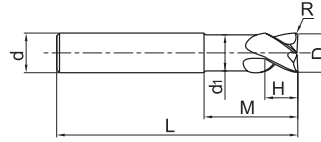

● Very suitable for super high speed milling of Al workpiece.

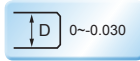
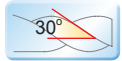

Type	Basic dimension(mm)							Number of teeth Z	Stock
	D	R	d	d ₁	H	M	L		
AL-3R-D12.0R1.0- AIR	12.0	1.0	12	11.0	12	37	83	3	○
AL-3R-D12.0R2.0- AIR	12.0	2.0	12	11.0	12	37	83	3	○
AL-3R-D12.0R3.0- AIR	12.0	3.0	12	11.0	12	37	83	3	○
AL-3R-D16.0R1.0- AIR	16.0	1.0	16	15.0	16	43	92	3	○
AL-3R-D16.0R2.0- AIR	16.0	2.0	16	15.0	16	43	92	3	○
AL-3R-D16.0R3.0- AIR	16.0	3.0	16	15.0	16	43	92	3	○
AL-3R-D16.0R4.0- AIR	16.0	4.0	16	15.0	16	43	92	3	○
AL-3R-D20.0R1.0- AIR	20.0	1.0	20	19.0	20	53	104	3	○
AL-3R-D20.0R2.0- AIR	20.0	2.0	20	19.0	20	53	104	3	○
AL-3R-D20.0R3.0- AIR	20.0	3.0	20	19.0	20	53	104	3	○
AL-3R-D20.0R4.0- AIR	20.0	4.0	20	19.0	20	53	104	3	○
AL-3R-D20.0R5.0- AIR	20.0	5.0	20	19.0	20	53	104	3	○
AL-3R-D20.0R6.0- AIR	20.0	6.0	20	19.0	20	53	104	3	○

● Stock available ○ Make-to-order

Indexable milling tools
Solid carbide end mills
AL series

Applicable workpiece material table ●Very suitable ○Suitable

Workpiece material											
Carbon steel	Alloy steel	Pre-hardened steel、Hardened steel				Stainless steel	Cast iron, Nodular cast iron	Copper alloy	Aluminum alloy	Titanium alloy	Heat resistant alloy
		~40HRC	~50HRC	~55HRC	~68HRC						
									●		



3-flute R end mills with straight and long shank



super high speed AL-3RL-AIR

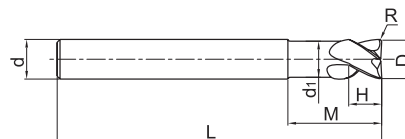

● Very suitable for super high speed milling of Al workpiece.

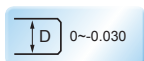

Type	Basic dimension(mm)							Number of teeth Z	Stock
	D	R	d	d ₁	H	M	L		
AL-3RL-D12.0R1.0- AIR	12.0	1.0	12	11.0	12	74	120	3	○
AL-3RL-D12.0R2.0- AIR	12.0	2.0	12	11.0	12	74	120	3	○
AL-3RL-D12.0R3.0- AIR	12.0	3.0	12	11.0	12	74	120	3	○
AL-3RL-D16.0R1.0- AIR	16.0	1.0	16	15.0	16	84	140	3	○
AL-3RL-D16.0R2.0- AIR	16.0	2.0	16	15.0	16	84	140	3	○
AL-3RL-D16.0R3.0- AIR	16.0	3.0	16	15.0	16	84	140	3	○
AL-3RL-D16.0R4.0- AIR	16.0	4.0	16	15.0	16	84	140	3	○
AL-3RL-D20.0R1.0- AIR	20.0	1.0	20	19.0	20	89	140	3	○
AL-3RL-D20.0R2.0- AIR	20.0	2.0	20	19.0	20	89	140	3	○
AL-3RL-D20.0R3.0- AIR	20.0	3.0	20	19.0	20	89	140	3	○
AL-3RL-D20.0R4.0- AIR	20.0	4.0	20	19.0	20	89	140	3	○
AL-3RL-D20.0R5.0- AIR	20.0	5.0	20	19.0	20	89	140	3	○
AL-3RL-D20.0R6.0- AIR	20.0	6.0	20	19.0	20	89	140	3	○

● Stock available ○ Make-to-order

Indexable milling tools

Solid carbide end mills

AL series

Applicable workpiece material table ● Very suitable ○ Suitable

Workpiece material											
Carbon steel	Alloy steel	Pre-hardened steel, Hardened steel				Stainless steel	Cast iron, Nodular cast iron	Copper alloy	Aluminum alloy	Titanium alloy	Heat resistant alloy
		~40HRC	~50HRC	~55HRC	~68HRC						
								●			

Code key

B258

Graphics category and identification

B259

Cutting parameters

B554

Non-standard customization

B570-B571

ALG series

Aluminum machining end mills

ALG series aluminum machining end mills are highly versatile and can achieve efficient cutting of aluminum alloy in various working conditions, with sharp edge design, light and fast cutting, excellent anti-bonding wear performance and high surface quality.

- ▶ Super fine grain carbide matrix, perfect combination of tool wear resistance and cutting edge strength;
- ▶ Special design of the chip tank realizes the perfect unification of tool strength and chip removal performance, which greatly improves the cutting stability;
- ▶ Large rake angle and sharp cutting edge design, effectively avoiding the generation of chip tumors;
- ▶ Optimized design of the flank surface and special surface treatment, the parts are machined with excellent surface quality.



Two cutting edges

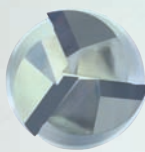

Three cutting edges

Application examples

Tool : ALG-3E-D8.0
Processing material: Aluminum alloy(HB110)
Machine: Machining center
Machining type: Side milling
Clamping type: Hydraulic toolholder
Cooling type: Emulsion
Cutting parameters : $n=13000r/min$,
 $f=900mm/min$, $a_p=8mm$, $a_e=0.5mm$

Machining surface quality comparison



ZCC-CT product

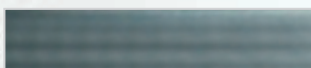

Company A's product

2-flute flattened end mills with straight shank



ALG-2E



- Good chip removal performance, high machining efficiency.

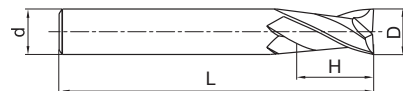
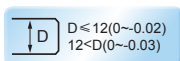

Picture 1

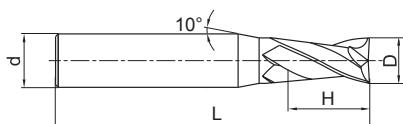

Picture 2

Type	Basic dimension(mm)				Number of teeth Z	Geometry	Stock
	D	d	H	L			
ALG-2E-D1.0	1.0	4	3	50	2	Picture 2	○
ALG-2E-D1.5	1.5	4	4	50	2	Picture 2	○
ALG-2E-D2.0	2.0	4	6	50	2	Picture 2	○
ALG-2E-D2.5	2.5	4	8	50	2	Picture 2	○
ALG-2E-D3.0S	3.0	4	8	50	2	Picture 2	○
ALG-2E-D3.0	3.0	6	8	50	2	Picture 2	○
ALG-2E-D3.5S	3.5	4	10	50	2	Picture 2	○
ALG-2E-D3.5	3.5	6	10	50	2	Picture 2	○
ALG-2E-D4.0S	4.0	4	11	50	2	Picture 1	○
ALG-2E-D4.0	4.0	6	11	50	2	Picture 2	○
ALG-2E-D4.5	4.5	6	11	50	2	Picture 2	○
ALG-2E-D5.0	5.0	6	13	50	2	Picture 2	○
ALG-2E-D5.5	5.5	6	16	50	2	Picture 2	○
ALG-2E-D6.0	6.0	6	16	50	2	Picture 1	○
ALG-2E-D7.0	7.0	8	20	60	2	Picture 2	○
ALG-2E-D8.0	8.0	8	20	60	2	Picture 1	○
ALG-2E-D9.0	9.0	10	22	75	2	Picture 2	○
ALG-2E-D10.0	10.0	10	25	75	2	Picture 1	○
ALG-2E-D11.0	11.0	12	26	75	2	Picture 2	○
ALG-2E-D12.0	12.0	12	30	75	2	Picture 1	○
ALG-2E-D14.0	14.0	14	32	75	2	Picture 1	○
ALG-2E-D16.0	16.0	16	45	100	2	Picture 1	○
ALG-2E-D18.0	18.0	18	45	100	2	Picture 1	○
ALG-2E-D20.0	20.0	20	45	100	2	Picture 1	○

● Stock available ○ Make-to-order

Applicable workpiece material table

● Very suitable ○ Suitable

Workpiece material											
Carbon steel	Alloy steel	Pre-hardened steel, Hardened steel				Stainless steel	Cast iron, Nodular cast iron	Copper alloy	Aluminum alloy	Titanium alloy	Heat resistant alloy
		~40HRC	~50HRC	~55HRC	~68HRC						
							●	●			

Code key

B258

Graphics category and identification

B259

Cutting parameters

B555

Non-standard customization

B570-B571

3-flute flattened end mills with straight shank



ALG-3E



● Good chip removal performance, can achieve high-precision machining.

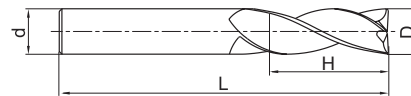
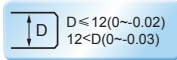

Picture 1

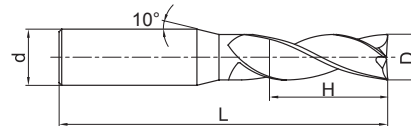

Picture 2

Type	Basic dimension(mm)				Number of teeth Z	Geometry	Stock
	D	d	H	L			
ALG-3E-D1.0	1.0	4	3	50	3	Picture 2	○
ALG-3E-D1.5	1.5	4	4	50	3	Picture 2	○
ALG-3E-D2.0	2.0	4	6	50	3	Picture 2	○
ALG-3E-D2.5	2.5	4	8	50	3	Picture 2	○
ALG-3E-D3.0S	3.0	4	8	50	3	Picture 2	○
ALG-3E-D3.0	3.0	6	8	50	3	Picture 2	○
ALG-3E-D4.0S	4.0	4	11	50	3	Picture 1	○
ALG-3E-D4.0	4.0	6	11	50	3	Picture 2	○
ALG-3E-D4.5	4.5	6	11	50	3	Picture 2	○
ALG-3E-D5.0	5.0	6	13	50	3	Picture 2	○
ALG-3E-D5.5	5.5	6	16	50	3	Picture 2	○
ALG-3E-D6.0	6.0	6	16	50	3	Picture 1	○
ALG-3E-D7.0	7.0	8	20	60	3	Picture 2	○
ALG-3E-D8.0	8.0	8	20	60	3	Picture 1	○
ALG-3E-D9.0	9.0	10	22	75	3	Picture 2	○
ALG-3E-D10.0	10.0	10	25	75	3	Picture 1	○
ALG-3E-D11.0	11.0	12	26	75	3	Picture 2	○
ALG-3E-D12.0	12.0	12	30	75	3	Picture 1	○
ALG-3E-D14.0	14.0	14	32	75	3	Picture 1	○
ALG-3E-D16.0	16.0	16	45	100	3	Picture 1	○
ALG-3E-D18.0	18.0	18	45	100	3	Picture 1	○
ALG-3E-D20.0	20.0	20	45	100	3	Picture 1	○

● Stock available ○ Make-to-order

➤ Applicable workpiece material table ○ Very suitable ○ Suitable

Workpiece material											
Carbon steel	Alloy steel	Pre-hardened steel, Hardened steel				Stainless steel	Cast iron, Nodular cast iron	Copper alloy	Aluminum alloy	Titanium alloy	Heat resistant alloy
		~40HRC	~50HRC	~55HRC	~68HRC						
								○	○		

Code key **B258**

Graphics category and identification **B259**

Cutting parameters **B556**

Non-standard customization **B570-B571**

Indexable milling tools
Solid carbide end mills
ALG series

2-flute R end mills with straight shank



ALG-2R



● very suitable for super high speed milling of Al workpiece.

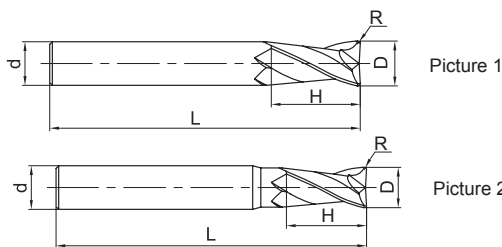
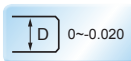
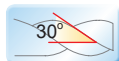

Indexable milling tools
Solid carbide end mills
ALG series

Type	Basic dimension(mm)					Number of teeth Z	Geometry	Stock
	D	R	d	H	L			
ALG-2R-D1.0R0.2S	1.0	0.2	4	3	50	2	Picture 2	○
ALG-2R-D1.5R0.2S	1.5	0.2	4	4	50	2	Picture 2	○
ALG-2R-D2.0R0.2S	2.0	0.2	4	6	50	2	Picture 2	○
ALG-2R-D2.0R0.5S	2.0	0.5	4	6	50	2	Picture 2	○
ALG-2R-D2.5R0.2S	2.5	0.2	4	8	50	2	Picture 2	○
ALG-2R-D2.5R0.5S	2.5	0.5	4	8	50	2	Picture 2	○
ALG-2R-D3.0R0.2S	3.0	0.2	4	8	50	2	Picture 2	○
ALG-2R-D3.0R0.5S	3.0	0.5	4	8	50	2	Picture 2	○
ALG-2R-D3.5R0.2S	3.5	0.2	4	10	50	2	Picture 2	○
ALG-2R-D3.5R0.5S	3.5	0.5	4	10	50	2	Picture 2	○
ALG-2R-D4.0R0.2S	4.0	0.2	4	11	50	2	Picture 1	○
ALG-2R-D4.0R0.5S	4.0	0.5	4	11	50	2	Picture 1	○
ALG-2R-D4.0R1.0S	4.0	1.0	4	11	50	2	Picture 1	○
ALG-2R-D6.0R0.3	6.0	0.3	6	16	50	2	Picture 1	○
ALG-2R-D6.0R0.5	6.0	0.5	6	16	50	2	Picture 1	○
ALG-2R-D6.0R1.0	6.0	1.0	6	16	50	2	Picture 1	○
ALG-2R-D8.0R0.3	8.0	0.3	8	20	60	2	Picture 1	○
ALG-2R-D8.0R0.5	8.0	0.5	8	20	60	2	Picture 1	○
ALG-2R-D8.0R1.0	8.0	1.0	8	20	60	2	Picture 1	○
ALG-2R-D10.0R0.3	10.0	0.3	10	25	75	2	Picture 1	○
ALG-2R-D10.0R0.5	10.0	0.5	10	25	75	2	Picture 1	○
ALG-2R-D10.0R1.0	10.0	1.0	10	25	75	2	Picture 1	○
ALG-2R-D10.0R1.5	10.0	1.5	10	25	75	2	Picture 1	○
ALG-2R-D10.0R2.0	10.0	2.0	10	25	75	2	Picture 1	○
ALG-2R-D12.0R0.3	12.0	0.3	12	30	75	2	Picture 1	○
ALG-2R-D12.0R0.5	12.0	0.5	12	30	75	2	Picture 1	○
ALG-2R-D12.0R1.0	12.0	1.0	12	30	75	2	Picture 1	○
ALG-2R-D12.0R1.5	12.0	1.5	12	30	75	2	Picture 1	○
ALG-2R-D12.0R2.0	12.0	2.0	12	30	75	2	Picture 1	○

➤ Applicable workpiece material table ● Very suitable ○ Suitable ● Stock available ○ Make-to-order

Workpiece material											
Carbon steel	Alloy steel	Pre-hardened steel, Hardened steel				Stainless steel	Cast iron, Nodular cast iron	Copper alloy	Aluminum alloy	Titanium alloy	Heat resistant alloy
		~40HRC	~50HRC	~55HRC	~68HRC						
							●	●			

Code key

B258

Graphics category and identification

B259

Cutting parameters

B557

Non-standard customization

B570-B571

3-flute R end mills with straight shank



ALG-3R



● very suitable for super high speed milling of Al workpiece.

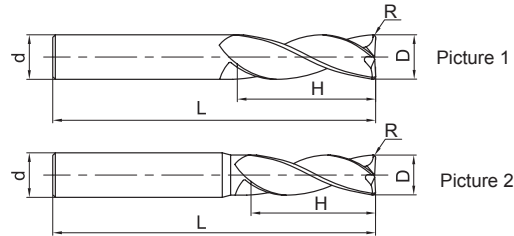
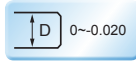
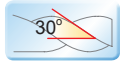

Type	Basic dimension(mm)					Number of teeth Z	Geometry	Stock
	D	R	d	H	L			
ALG-3R-D1.0R0.2S	1.0	0.2	4	3	50	3	Picture 2	○
ALG-3R-D1.5R0.2S	1.5	0.2	4	4	50	3	Picture 2	○
ALG-3R-D2.0R0.2S	2.0	0.2	4	6	50	3	Picture 2	○
ALG-3R-D2.0R0.5S	2.0	0.5	4	6	50	3	Picture 2	○
ALG-3R-D2.5R0.2S	2.5	0.2	4	8	50	3	Picture 2	○
ALG-3R-D2.5R0.5S	2.5	0.5	4	8	50	3	Picture 2	○
ALG-3R-D3.0R0.2S	3.0	0.2	4	8	50	3	Picture 2	○
ALG-3R-D3.0R0.5S	3.0	0.5	4	8	50	3	Picture 2	○
ALG-3R-D3.5R0.2S	3.5	0.2	4	10	50	3	Picture 2	○
ALG-3R-D3.5R0.5S	3.5	0.5	4	10	50	3	Picture 2	○
ALG-3R-D4.0R0.2S	4.0	0.2	4	11	50	3	Picture 1	○
ALG-3R-D4.0R0.5S	4.0	0.5	4	11	50	3	Picture 1	○
ALG-3R-D4.0R1.0S	4.0	1.0	4	11	50	3	Picture 1	○
ALG-3R-D6.0R0.3	6.0	0.3	6	16	50	3	Picture 1	○
ALG-3R-D6.0R0.5	6.0	0.5	6	16	50	3	Picture 1	○
ALG-3R-D6.0R1.0	6.0	1.0	6	16	50	3	Picture 1	○
ALG-3R-D8.0R0.3	8.0	0.3	8	20	60	3	Picture 1	○
ALG-3R-D8.0R0.5	8.0	0.5	8	20	60	3	Picture 1	○
ALG-3R-D8.0R1.0	8.0	1.0	8	20	60	3	Picture 1	○
ALG-3R-D10.0R0.3	10.0	0.3	10	25	75	3	Picture 1	○
ALG-3R-D10.0R0.5	10.0	0.5	10	25	75	3	Picture 1	○
ALG-3R-D10.0R1.0	10.0	1.0	10	25	75	3	Picture 1	○
ALG-3R-D10.0R1.5	10.0	1.5	10	25	75	3	Picture 1	○
ALG-3R-D10.0R2.0	10.0	2.0	10	25	75	3	Picture 1	○
ALG-3R-D12.0R0.3	12.0	0.3	12	30	75	3	Picture 1	○
ALG-3R-D12.0R0.5	12.0	0.5	12	30	75	3	Picture 1	○
ALG-3R-D12.0R1.0	12.0	1.0	12	30	75	3	Picture 1	○
ALG-3R-D12.0R1.5	12.0	1.5	12	30	75	3	Picture 1	○
ALG-3R-D12.0R2.0	12.0	2.0	12	30	75	3	Picture 1	○

➤ Applicable workpiece material table ● Very suitable ○ Suitable ● Stock available ○ Make-to-order

Workpiece material											
Carbon steel	Alloy steel	Pre-hardened steel, Hardened steel				Stainless steel	Cast iron, Nodular cast iron	Copper alloy	Aluminum alloy	Titanium alloy	Heat resistant alloy
		~40HRC	~50HRC	~55HRC	~68HRC						
								●	●		

Code key

B258

Graphics category and identification

B259

Cutting parameters

B558

Non-standard customization

B570-B571

Indexable milling tools
Solid carbide end mills
ALG series

S_M

series end mills for machining of hard-to-cut materials such as stainless steel, heat-resistant alloy, etc.

- Large helical and rake angle, sharp cutting edge, unique edge geometry can restrain cutting-heat's influence on tool nose, and greatly improve wear resistance and heat resistance.
- The coating with good heat resistance can achieve stable machining even at high temperature.
- Very suitable for machining of hard-to-cut materials such as stainless steel, Ni substrate high temperature alloy, etc.

Tool type: SM-3E-D6.0
 Dimensions: Ø6mm
 Workpiece material: 1Cr18Ni9Ti
 Rotating speed: 3700r/min (70m/min)
 Feed speed: 555mm/min(0.15mm/r)
 Axial cutting depth: $a_p=9\text{mm}$
 Radial cutting depth: $a_e=0.6\text{mm}$
 Cutting style: side milling (down milling)
 Cooling system: oil water emulsion
 Machine tool: MIKRON UCP 1000

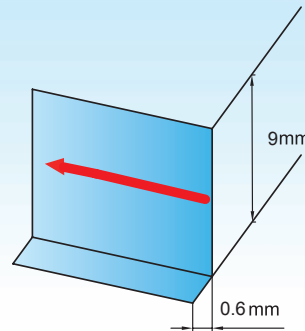

End mills	SM-3E-D6.0	Similar product of company A
Cutting length	100m	100m
Abrasion of peripheral edge	Even abrasion on cutting edge, value is 0.08 mm	Cutting edge is flaked fully, value is 0.135mm

Abrasion condition of peripheral edge

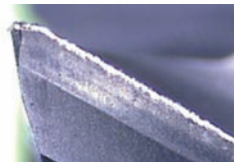

VSM series

End mills with unequal pitch and variable inclined angle;
Revolution on machining materials hard to cut: stainless
steel, heat resistant alloy, etc.

VSM-4E **VSM-4R**
VSM-4EFP **VSM-4RFP**

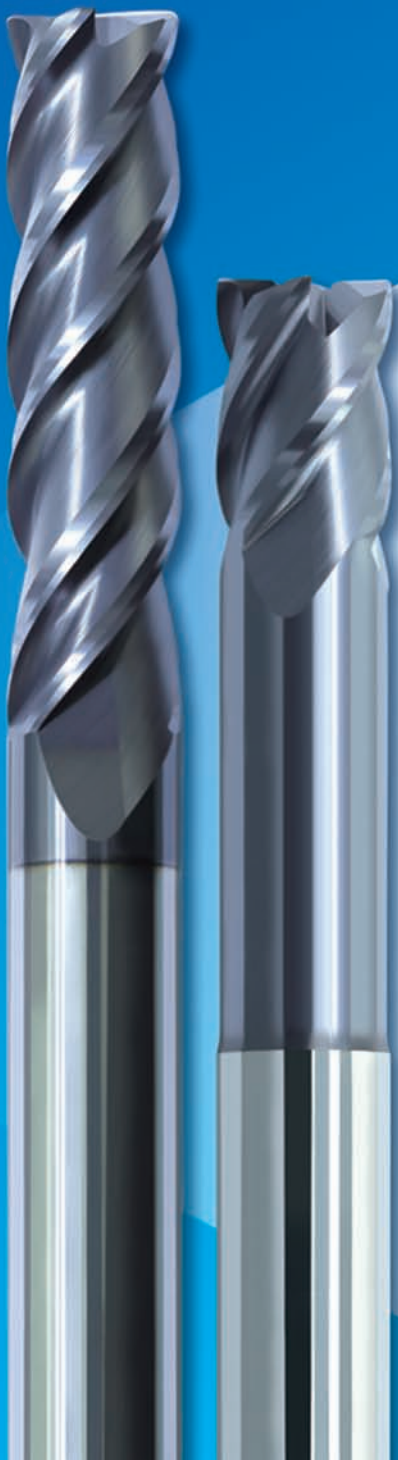

⚙️ VSM-4E-D12.0 Slotting stainless steel

Machine: MIKRON UCP1000

Chuck: HSK63-A

Machined material: 1Cr18Ni9Ti

Cutting speed: 80m/min

Feed per tooth: 0.05mm/z

Axial cutting depth: 6mm

Radial cutting depth: 12mm

Cooling system: air cooling

Cutting style: slotting

Overhang: 35mm

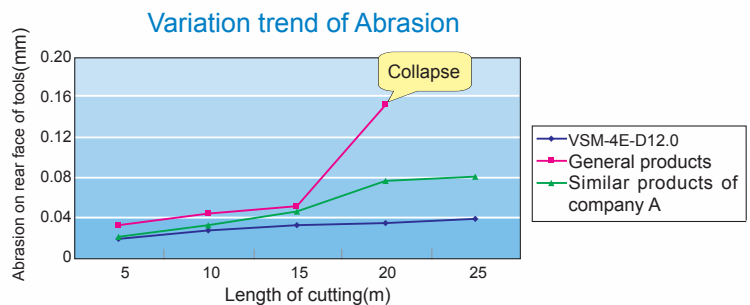
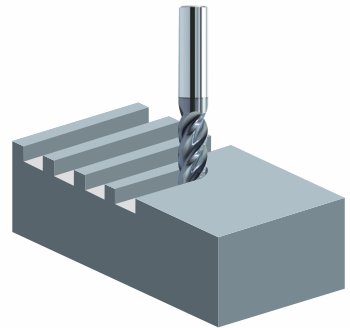

Note: ◆ Compared with competitor's, VSM end mills can perform better on wear resistance and tool life.

◆ Compared common tools, unequal pitch end mills perform stronger on resisting broken.

SM/VSM series for machining materials hard to cut

3-flute flattened end mills with straight shank



SM-3E



● Large helical angle, for machining of hard-to-cut materials such as Austenite stainless steel, heat-resistant alloy, etc.

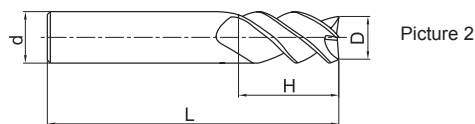
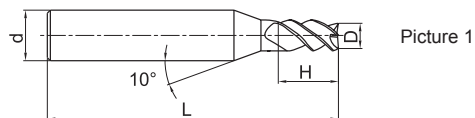
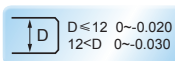
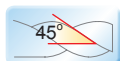

Type	Basic dimension(mm)				Number of teeth Z	Geometry	Stock
	D	d	H	L			
SM-3E-D3.0	3.0	6	8	50	3	Picture 1	○
SM-3E-D4.0	4.0	6	11	50	3	Picture 1	○
SM-3E-D5.0	5.0	6	13	50	3	Picture 1	○
SM-3E-D6.0	6.0	6	16	50	3	Picture 2	○
SM-3E-D7.0	7.0	8	20	60	3	Picture 1	○
SM-3E-D8.0	8.0	8	20	60	3	Picture 2	○
SM-3E-D9.0	9.0	10	22	75	3	Picture 1	○
SM-3E-D10.0	10.0	10	25	75	3	Picture 2	○
SM-3E-D11.0	11.0	12	26	75	3	Picture 1	○
SM-3E-D12.0	12.0	12	30	75	3	Picture 2	○
SM-3E-D16.0	16.0	16	45	100	3	Picture 2	○
SM-3E-D20.0	20.0	20	45	100	3	Picture 2	○

● Stock available ○ Make-to-order

Indexable milling tools

Solid carbide end mills

SM series

Applicable workpiece material table ○ Very suitable ○ Suitable

Workpiece material											
Carbon steel	Alloy steel	Pre-hardened steel, Hardened steel				Stainless steel	Cast iron, Nodular cast iron	Copper alloy	Aluminum alloy	Titanium alloy	Heat resistant alloy
		~40HRC	~50HRC	~55HRC	~68HRC						
○	○					○					

Code key

B258

Graphics category and identification

B259

Cutting parameters

B559

Non-standard customization

B570-B571

4-flutes unequal pitch end mills with straight shank



VSM-4E



- With variable inclined angle design, greatly improving the anti vibration performance.
- Very suitable for machining materials hard to cut :such as stainless steel,heat resist alloy and Ti-base alloy.

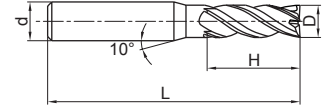
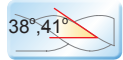

Picture 1

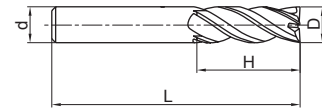

Picture 2

Type	Basic dimension(mm)				Number of teeth Z	Geometry	Stock
	D	d	H	L			
VSM-4E-D4.0	4.0	6	11	50	4	Picture 1	●
VSM-4E-D5.0	5.0	6	13	50	4	Picture 1	●
VSM-4E-D6.0	6.0	6	16	50	4	Picture 2	●
VSM-4E-D8.0	8.0	8	20	60	4	Picture 2	●
VSM-4E-D10.0	10.0	10	25	75	4	Picture 2	●
VSM-4E-D12.0	12.0	12	30	75	4	Picture 2	●
VSM-4E-D16.0	16.0	16	45	100	4	Picture 2	●
VSM-4E-D20.0	20.0	20	45	100	4	Picture 2	●

● Stock available ○ Make-to-order

Indexable milling tools
Solid carbide end mills
VSM series

➤ Applicable workpiece material table ○Very suitable ○Suitable

Workpiece material											
Carbon steel	Alloy steel	Pre-hardened steel, Hardened steel				Stainless steel	Cast iron, Nodular cast iron	Copper alloy	Aluminum alloy	Titanium alloy	Heat resistant alloy
		~40HRC	~50HRC	~55HRC	~68HRC						
○	○					○				○	○



SM/VSM series for machining materials hard to cut

4-flutes flattened end mills with straight shank, unequal pitch, long neck and short cutting edges



VSM-4EFP

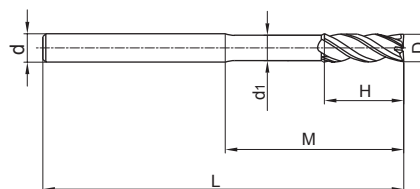

- With variable inclined angle design, greatly improving the anti vibration performance.
- Very suitable for machining materials hard to cut :such as stainless steel,heat resist alloy and Ti-base alloy.

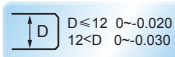
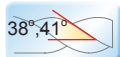

Type	Basic dimension(mm)						Number of teeth Z	Stock
	D	d	H	M	d ₁	L		
VSM-4EFP-D6.0	6.0	6	9	27	5.7	75	4	●
VSM-4EFP-D8.0	8.0	8	12	36	7.7	100	4	●
VSM-4EFP-D10.0	10.0	10	14	42	9.5	100	4	●
VSM-4EFP-D12.0	12.0	12	16	48	11.5	100	4	●
VSM-4EFP-D16.0	16.0	16	20	60	15.5	150	4	●

● Stock available ○ Make-to-order

Indexable
milling tools

Solid carbide
end mills

VSM series

Applicable workpiece material table ○ Very suitable ○ Suitable

Workpiece material											
Carbon steel	Alloy steel	Pre-hardened steel, Hardened steel				Stainless steel	Cast iron, Nodular cast iron	Copper alloy	Aluminum alloy	Titanium alloy	Heat resistant alloy
		~40HRC	~50HRC	~55HRC	~68HRC						
○	○					○				○	○

Code key

B258

Graphics category and identification

B259

Cutting parameters

B560

Non-standard customization

B570-B571

4-flute R end mills with straight shank



SM-4R

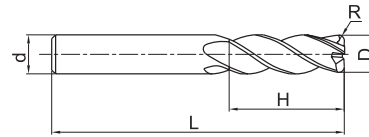

● Large helical angle and strong nose, for machining of hard-to-cut materials such as austenitic stainless steel, heat-resistant alloy, etc.

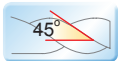

Type	Basic dimension(mm)					Number of teeth Z	Stock
	D	R	d	H	L		
SM-4R-D6.0R0.5	6.0	0.5	6	16	50	4	○
SM-4R-D6.0R1.0	6.0	1.0	6	16	50	4	○
SM-4R-D8.0R0.5	8.0	0.5	8	20	60	4	○
SM-4R-D8.0R1.0	8.0	1.0	8	20	60	4	○
SM-4R-D10.0R0.5	10.0	0.5	10	25	75	4	○
SM-4R-D10.0R1.0	10.0	1.0	10	25	75	4	○
SM-4R-D12.0R0.5	12.0	0.5	12	30	75	4	○
SM-4R-D12.0R1.0	12.0	1.0	12	30	75	4	○

● Stock available ○ Make-to-order

Indexable milling tools

Solid carbide end mills

SM series

➤ Applicable workpiece material table ○Very suitable ○Suitable

Workpiece material											
Carbon steel	Alloy steel	Pre-hardened steel, Hardened steel				Stainless steel	Cast iron, Nodular cast iron	Copper alloy	Aluminum alloy	Titanium alloy	Heat resistant alloy
		~40HRC	~50HRC	~55HRC	~68HRC						
○	○					○					

Code key **B258**

Graphics category and identification **B259**

Cutting parameters **B561**

Non-standard customization **B570-B571**

4-flute R end mills with straight shank



VSM-4R

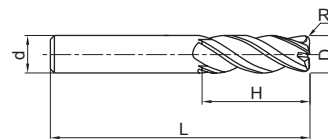

● Large helical angle and strong nose, for machining of hard-to-cut materials such as austenitic stainless steel, heat-resistant alloy, etc.

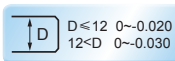
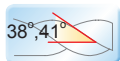

Type	Basic dimension(mm)					Number of teeth Z	Stock
	D	R	d	H	L		
VSM-4R-D6.0R0.5	6.0	0.5	6	16	50	4	●
VSM-4R-D6.0R1.0	6.0	1.0	6	16	50	4	●
VSM-4R-D8.0R0.5	8.0	0.5	8	20	60	4	●
VSM-4R-D8.0R1.0	8.0	1.0	8	20	60	4	●
VSM-4R-D10.0R0.5	10.0	0.5	10	25	75	4	●
VSM-4R-D10.0R1.0	10.0	1.0	10	25	75	4	●
VSM-4R-D10.0R2.0	10.0	2.0	10	25	75	4	●
VSM-4R-D12.0R0.5	12.0	0.5	12	30	75	4	●
VSM-4R-D12.0R1.0	12.0	1.0	12	30	75	4	●
VSM-4R-D12.0R2.0	12.0	2.0	12	30	75	4	●
VSM-4R-D16.0R1.0	16.0	1.0	16	45	100	4	●
VSM-4R-D16.0R2.0	16.0	2.0	16	45	100	4	●
VSM-4R-D16.0R3.0	16.0	3.0	16	45	100	4	●
VSM-4R-D20.0R1.0	20.0	1.0	20	45	100	4	●
VSM-4R-D20.0R2.0	20.0	2.0	20	45	100	4	●
VSM-4R-D20.0R3.0	20.0	3.0	20	45	100	4	●

● Stock available ○ Make-to-order

Indexable milling tools

Solid carbide end mills

VSM series

Applicable workpiece material table ○Very suitable ○Suitable

Workpiece material											
Carbon steel	Alloy steel	Pre-hardened steel, Hardened steel				Stainless steel	Cast iron, Nodular cast iron	Copper alloy	Aluminum alloy	Titanium alloy	Heat resistant alloy
		~40HRC	~50HRC	~55HRC	~68HRC						
○	○					○				○	○

Code key

B258

Graphics category and identification

B259

Cutting parameters

B562

Non-standard customization

B570-B571

4-flutes R end mills with straight shank, unequal pitch, long neck and short cutting edges



VSM-4RFP

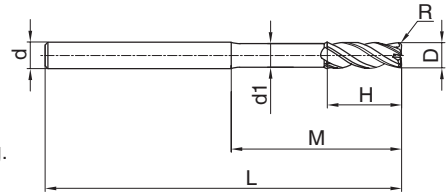

- With high rigidity short cutting edges design, suitable for deep cavity machining.
- With variable helical angle design, great improved vibration resistance and surface quality after machining.



Type	Basic dimension(mm)							Number of teeth Z	Stock
	D	R	d	d ₁	H	M	L		
VSM-4RFP-D6.0R0.5	6.0	0.5	6	5.7	9	27	75	4	●
VSM-4RFP-D6.0R1.0	6.0	1.0	6	5.7	9	27	75	4	●
VSM-4RFP-D8.0R0.5	8.0	0.5	8	7.7	12	36	100	4	●
VSM-4RFP-D8.0R1.0	8.0	1.0	8	7.7	12	36	100	4	●
VSM-4RFP-D10.0R0.5	10.0	0.5	10	9.5	14	42	100	4	●
VSM-4RFP-D10.0R1.0	10.0	1.0	10	9.5	14	42	100	4	●
VSM-4RFP-D10.0R2.0	10.0	2.0	10	9.5	14	42	100	4	●
VSM-4RFP-D12.0R0.5	12.0	0.5	12	11.5	16	48	100	4	●
VSM-4RFP-D12.0R1.0	12.0	1.0	12	11.5	16	48	100	4	●
VSM-4RFP-D12.0R2.0	12.0	2.0	12	11.5	16	48	100	4	●
VSM-4RFP-D16.0R1.0	16.0	1.0	16	15.5	20	60	150	4	●
VSM-4RFP-D16.0R2.0	16.0	2.0	16	15.5	20	60	150	4	●

● Stock available ○ Make-to-order

Indexable milling tools
Solid carbide end mills
VSM series

Applicable workpiece material table ○ Very suitable ○ Suitable

Workpiece material											
Carbon steel	Alloy steel	Pre-hardened steel, Hardened steel				Stainless steel	Cast iron, Nodular cast iron	Copper alloy	Aluminum alloy	Titanium alloy	Heat resistant alloy
		~40HRC	~50HRC	~55HRC	~68HRC						
○	○					○				○	○



CM series for general chamfering

2-flute helical flute chamfer end mills with straight shank



CM-2E

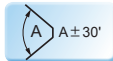
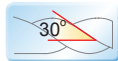
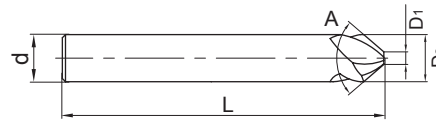

Type	Basic dimension(mm)					Number of teeth Z	Stock
	A	D1	D2	d	L		
CM-2E-D3.0-A60	60°	0.2	3	3	50	2	○
CM-2E-D4.0-A60	60°	0.2	4	4	50	2	○
CM-2E-D6.0-A60	60°	0.2	6	6	50	2	○
CM-2E-D8.0-A60	60°	0.5	8	8	60	2	○
CM-2E-D10.0-A60	60°	0.5	10	10	75	2	○
CM-2E-D12.0-A60	60°	0.5	12	12	75	2	○
CM-2E-D16.0-A60	60°	0.7	16	16	100	2	○
CM-2E-D3.0-A90	90°	0.2	3	3	50	2	○
CM-2E-D4.0-A90	90°	0.2	4	4	50	2	○
CM-2E-D6.0-A90	90°	0.2	6	6	50	2	○
CM-2E-D8.0-A90	90°	0.5	8	8	60	2	○
CM-2E-D10.0-A90	90°	0.5	10	10	75	2	○
CM-2E-D12.0-A90	90°	0.5	12	12	75	2	○
CM-2E-D16.0-A90	90°	0.7	16	16	100	2	○
CM-2E-D3.0-A120	120°	0.2	3	3	50	2	○
CM-2E-D4.0-A120	120°	0.2	4	4	50	2	○
CM-2E-D6.0-A120	120°	0.2	6	6	50	2	○
CM-2E-D8.0-A120	120°	0.5	8	8	60	2	○
CM-2E-D10.0-A120	120°	0.5	10	10	75	2	○
CM-2E-D12.0-A120	120°	0.5	12	12	75	2	○
CM-2E-D16.0-A120	120°	0.7	16	16	100	2	○

● Stock available ○ Make-to-order

Applicable workpiece material table ○ Very suitable ○ Suitable

Workpiece material											
Carbon steel	Alloy steel	Pre-hardened steel, Hardened steel				Stainless steel	Cast iron, Nodular cast iron	Copper alloy	Aluminum alloy	Titanium alloy	Heat resistant alloy
		~40HRC	~50HRC	~55HRC	~68HRC						
○	○	○	○	○	○	○	○	○	○	○	

Code key

B258

Graphics category and identification

B259

Cutting parameters

B563

Non-standard customization

B570-B571

4-flute helical flute chamfer end mills with straight shank



CM-4E

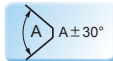
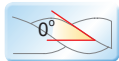
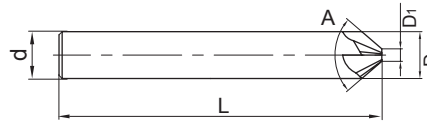

Type	Basic dimension(mm)					Number of teeth Z	Stock
	A	D ₁ (±0.02)	D ₂	d(h6)	L		
CM-4E-D3.0-B60	60°	0.2	3	3	50	4	○
CM-4E-D4.0-B60	60°	0.2	4	4	50	4	○
CM-4E-D6.0-B60	60°	0.2	6	6	50	4	○
CM-4E-D8.0-B60	60°	0.5	8	8	60	4	○
CM-4E-D10.0-B60	60°	0.5	10	10	75	4	○
CM-4E-D12.0-B60	60°	0.5	12	12	75	4	○
CM-4E-D16.0-B60	60°	0.7	16	16	100	4	○
CM-4E-D3.0-B90	90°	0.2	3	3	50	4	○
CM-4E-D4.0-B90	90°	0.2	4	4	50	4	○
CM-4E-D6.0-B90	90°	0.2	6	6	50	4	○
CM-4E-D8.0-B90	90°	0.5	8	8	60	4	○
CM-4E-D10.0-B90	90°	0.5	10	10	75	4	○
CM-4E-D12.0-B90	90°	0.5	12	12	75	4	○
CM-4E-D16.0-B90	90°	0.7	16	16	100	4	○
CM-4E-D3.0-B120	120°	0.2	3	3	50	4	○
CM-4E-D4.0-B120	120°	0.2	4	4	50	4	○
CM-4E-D6.0-B120	120°	0.2	6	6	50	4	○
CM-4E-D8.0-B120	120°	0.5	8	8	60	4	○
CM-4E-D10.0-B120	120°	0.5	10	10	75	4	○
CM-4E-D12.0-B120	120°	0.5	12	12	75	4	○
CM-4E-D16.0-B120	120°	0.7	16	16	100	4	○

● Stock available ○ Make-to-order

Indexable milling tools

Solid carbide end mills

CM series

Applicable workpiece material table ○Very suitable ○Suitable

Workpiece material											
Carbon steel	Alloy steel	Pre-hardened steel, Hardened steel				Stainless steel	Cast iron, Nodular cast iron	Copper alloy	Aluminum alloy	Titanium alloy	Heat resistant alloy
		~40HRC	~50HRC	~55HRC	~68HRC						
○	○	○	○	○	○	○	○	○	○	○	



VPM-4E★VPM-4EBL/X★VPM-4EFP

Workpiece material	Cast iron, Carbon steel, Alloy steel ~30HRC		Stainless steel		Carbon steel, Alloy steel ~40HRC		Carbon steel, Alloy steel ~50HRC		Hardened steel ~55HRC	
	Diameter (mm)	Rotating speed (min ⁻¹)	Feed speed (mm/min)	Rotating speed (min ⁻¹)	Feed speed (mm/min)	Rotating speed (min ⁻¹)	Feed speed (mm/min)	Rotating speed (min ⁻¹)	Feed speed (mm/min)	Rotating speed (min ⁻¹)
3	15900	1220	8500	180	13270	950	10600	630	7430	360
4	11900	1260	6370	190	9950	970	8000	645	570	370
5	9500	1350	5060	190	7960	1010	6400	675	4460	390
6	7900	1330	4250	210	6630	1030	5300	690	3710	390
8	5900	1330	3180	210	4970	1020	4000	680	2785	405
10	4700	1310	2550	210	3980	1010	3200	675	2230	375
12	4000	1310	2120	210	3310	1010	2650	675	1855	375
14	3400	1220	1820	180	2840	945	2300	630	1590	360
16	3000	1220	1590	180	2480	945	2000	630	1390	360
18	2600	1200	1410	160	2210	930	1800	620	1240	350
20	2400	1200	1270	160	1990	930	1600	620	1115	350
Maximum cutting depth										

1. The above table shows the standard value of side milling. When milling slot, 60%~80% of rotating speed and 50%~70% of feed speed stated above are recommended as standard.
2. Please select high-precision machine and tool holder.
3. Please use air blow or cutting liquid with high mist retardant property.
4. Down milling is recommended in the case of side milling.
5. When the machine rigidity and workpiece fixture stability is low, vibration and abnormal noise may be generated. Please reduce the rotating speed and feed speed stated above correspondingly.
6. Make overhang of tool as short as possible in conditions of non-interference.

Indexable milling tools

Solid carbide end mills

Cutting parameters for VPM series end mills

VPM-4R★VPM-4RBL/X★VPM-4RFP

Workpiece material	Cast iron, Carbon steel, Alloy steel ~30HRC		Stainless steel		Carbon steel, Alloy steel ~40HRC		Carbon steel, Alloy steel ~50HRC		Hardened steel ~55HRC			
	Diameter (mm)	Rotating speed (min ⁻¹)	Feed speed (mm/min)	Rotating speed (min ⁻¹)	Feed speed (mm/min)	Rotating speed (min ⁻¹)	Feed speed (mm/min)	Rotating speed (min ⁻¹)	Feed speed (mm/min)	Rotating speed (min ⁻¹)	Feed speed (mm/min)	
3	15900	1460	8500	215	13270	1140	10600	755	7430	430		
4	11900	1510	6370	225	9950	1160	8000	770	570	440		
5	9500	1620	5060	225	7960	1210	6400	810	4460	465		
6	7900	1590	4250	250	6630	1235	5300	825	3710	465		
8	5900	1590	3180	250	4970	1220	4000	815	2785	485		
10	4700	157	2550	250	3980	1210	3200	810	2230	450		
12	4000	1570	2120	250	3310	1210	2650	810	1855	450		
14	3400	1460	1820	215	2840	1130	2300	755	1590	430		
16	3000	1460	1590	215	2480	1130	2000	755	1390	430		
18	2600	1440	1410	190	2210	1115	1800	740	1240	420		
20	2400	1440	1270	190	1990	1115	1600	740	1115	420		
Maximum cutting depth												

1. The above table shows the standard value of side milling. When milling slot, 60%~80% of rotating speed and 50%~70% of feed speed stated above are recommended as standard.
2. Please select high-precision machine and tool holder.
3. Please use air blow or cutting liquid with high mist retardant property.
4. Down milling is recommended in the case of side milling.
5. When the machine rigidity and workpiece fixture stability is low, vibration and abnormal noise may be generated. Please reduce the rotating speed and feed speed stated above correspondingly.
6. Make overhang of tool as short as possible in conditions of non-interference.

UM-4E★UM-4EL(general cutting)

Workpiece material	Cast iron, Carbon steel, Alloy steel ~30HRC		Stainless steel		Pre-hardened steel, quenched and tempered steel ~40HRC		Pre-hardened steel, quenched and tempered steel ~50HRC		Hardened steel ~55HRC	
	Diameter (mm)	Rotating speed (min ⁻¹)	Feed speed (mm/min)	Rotating speed (min ⁻¹)	Feed speed (mm/min)	Rotating speed (min ⁻¹)	Feed speed (mm/min)	Rotating speed (min ⁻¹)	Feed speed (mm/min)	Rotating speed (min ⁻¹)
4	10800	1000	5500	180	8000	770	6500	605	5570	440
5	8200	1050	4500	180	6400	810	5000	635	4460	465
6	7000	1080	3700	195	5300	825	4200	645	3710	465
8	5200	1065	2800	195	4000	815	3200	665	2785	485
10	4200	1050	2200	195	3200	810	2500	630	2230	450
12	3500	1050	1850	195	2650	810	2100	630	1855	450
14	3000	975	1600	180	2300	755	1800	595	1590	430
16	2600	975	1400	170	2000	755	1600	595	1390	430
18	2300	960	1250	150	1800	745	1400	580	1240	420
20	2050	960	1100	150	1600	745	1250	580	1115	420

Maximum cutting depth						
	Diameter range	Cutting depth ap	Diameter range	Cutting depth ap	Diameter range	Cutting depth ap
	Ø1 ≤ D < Ø3	0.15D		Ø1 ≤ D < Ø3	0.1D	
	Ø3 ≤ D < Ø6	0.3D		Ø3 ≤ D	0.2D	
	Ø6 ≤ D ≤ Ø20	0.5D				

- The above table shows the standard value of side milling. When milling slot, 50%~70% of rotating speed and 40%~60% of feed speed stated above are recommended as standard.
- Please select high-precision machine and tool holder.
- Please use air blow or cutting liquid with high mist retardant property.
- Down milling is recommended in the case of side milling.
- When the machine rigidity and workpiece fixture stability is low, vibration and abnormal noise may be generated. Please reduce the rotating speed and feed speed stated above correspondingly.
- Make overhang of tool as short as possible in conditions of non-interference.

UM-4E★UM-4EL(high speed side milling)

Workpiece material	Cast iron, Carbon steel, Alloy steel ~30HRC		Carbon steel, Alloy steel ~40HRC		Pre-hardened steel, quenched and tempered steel ~45HRC		Pre-hardened steel, quenched and tempered steel ~50HRC		Hardened steel ~55HRC	
Cutting speed	300m/min		250 m/min		200 m/min		150 m/min		100 m/min	
Diameter (mm)	Rotating speed (min ⁻¹)	Feed speed (mm/min)	Rotating speed (min ⁻¹)	Feed speed (mm/min)	Rotating speed (min ⁻¹)	Feed speed (mm/min)	Rotating speed (min ⁻¹)	Feed speed (mm/min)	Rotating speed (min ⁻¹)	Feed speed (mm/min)
6	15915	2045	13260	1700	10600	1360	7960	1020	5300	680
8	11935	2040	9950	1680	7960	1355	5970	1020	3980	680
10	9550	1990	7960	1655	6370	1330	4775	995	3180	660
12	7960	1990	6630	1655	5300	1330	3980	995	2650	660
14	6820	1850	5685	1545	4550	1235	3410	1080	2275	615
16	5970	1850	4975	1545	3980	1235	2985	1080	1990	615
18	5305	1850	4420	1545	3540	1235	2650	1080	1770	615
20	4775	1850	3980	1545	3180	1235	2390	1080	1590	615
Maximum cutting depth	<p style="text-align: center;">$a_e=0.05D$ $a_p=1.5D$ Maximum $a_e=1.0\text{mm}$</p>					<p style="text-align: center;">$a_e=0.03D$ $a_p=1D$ Maximum $a_e=0.5\text{mm}$</p>				

1. Please select high-precision machine and tool holder.
2. Please use air blow or MQL (minimum oil mist cooling).
3. Down milling is recommended in the case of side milling.
4. When the machine rigidity and workpiece fixture stability is low, vibration and abnormal noise may be generated. Please reduce the rotating speed and feed speed stated above correspondingly.
5. Make overhang of tool as short as possible in conditions of non-interference.

UM-4EFP(general cutting)

Workpiece material	Cast Iron, Nodular cast iron		Stainless steel		Carbon steel, Alloy steel ~40HRC		Carbon steel, Alloy steel ~50HRC		Hardened steel ~55HRC	
	Rotating speed (min ⁻¹)	Feed speed (mm/min)	Rotating speed (min ⁻¹)	Feed speed (mm/min)	Rotating speed (min ⁻¹)	Feed speed (mm/min)	Rotating speed (min ⁻¹)	Feed speed (mm/min)	Rotating speed (min ⁻¹)	Feed speed (mm/min)
6	7000	1400	3700	250	5300	1080	4200	845	3710	610
8	5200	1385	2800	250	4000	1060	3200	865	2785	630
10	4200	1365	2200	250	3200	1050	2500	815	2230	585
12	3500	1365	1850	250	2650	1050	2100	815	1855	585
16	2600	1270	1400	220	2000	975	1600	770	1390	560
20	2050	1255	1100	195	1600	965	1250	755	1115	545
Maximum cutting depth										

1. The above table shows the standard value of side milling. When milling slot, 50%~70% of rotating speed and 40%~60% of feed speed stated above are recommended as standard.
2. Please select high-precision machine and tool holder.
3. Please use air blow or cutting liquid with high mist retardant property.
4. Down milling is recommended in the case of side milling.
5. When the machine rigidity and workpiece fixture stability is low, vibration and abnormal noise may be generated. Please reduce the rotating speed and feed speed stated above correspondingly.
6. Make overhang of tool as short as possible in conditions of non-interference.

UM-4EFP (high speed side milling)

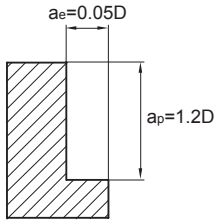
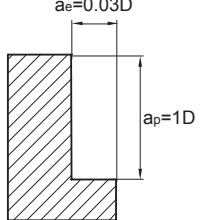
Workpiece material	Cast iron, Carbon steel, Alloy steel ~30HRC		Carbon steel, Alloy steel ~40HRC		Carbon steel, Alloy steel ~40HRC		Carbon steel, Alloy steel ~50HRC		Hardened steel ~55HRC	
Cutting speed	300m/min		250 m/min		200 m/min		150 m/min		100 m/min	
Diameter (mm)	Rotating speed (min ⁻¹)	Feed speed (mm/min)	Rotating speed (min ⁻¹)	Feed speed (mm/min)	Rotating speed (min ⁻¹)	Feed speed (mm/min)	Rotating speed (min ⁻¹)	Feed speed (mm/min)	Rotating speed (min ⁻¹)	Feed speed (mm/min)
6	15915	2655	13260	2210	10600	1770	7960	1325	5300	885
8	11935	2650	9950	2180	7960	1760	5970	1295	3980	885
10	9550	2590	7960	2150	6370	1730	4775	1295	3180	855
12	7960	2590	6630	2150	5300	1730	3980	1400	2650	855
16	5970	2410	4975	2015	3980	1605	2985	1400	1990	800
20	4775	2410	3980	2375	3180	1605	2390	1325	1590	800
Maximum cutting depth	 <p>Maximum $a_e=1.0\text{mm}$</p>						 <p>Maximum $a_e=0.5\text{mm}$</p>			

1. Please select high-precision machine and tool holder.
2. Please use air blow or MQL (minimum oil mist cooling).
3. Down milling is recommended in the case of side milling.
4. When the machine rigidity and workpiece fixture stability is low, vibration and abnormal noise may be generated. Please reduce the rotating speed and feed speed stated above correspondingly.
5. Make overhang of tool as short as possible in conditions of non-interference.

Cutting parameters for UM series end mills

UM-4R★UM-4RL(Standard)

Workpiece material	Cast iron, Carbon steel, Alloy steel ~30HRC		Quenched and tempered steel ~40HRC		Quenched and tempered steel ~45HRC		Quenched and tempered steel ~50HRC		Quenched and tempered steel ~55HRC	
	Rotating speed (min ⁻¹)	Feed speed (mm/min)	Rotating speed (min ⁻¹)	Feed speed (mm/min)	Rotating speed (min ⁻¹)	Feed speed (mm/min)	Rotating speed (min ⁻¹)	Feed speed (mm/min)	Rotating speed (min ⁻¹)	Feed speed (mm/min)
4.0×R0.3 4.0×R0.5	7950	3960	6350	2880	5550	2520	4000	1650	2400	755
5.0×R0.5 5.0×R1.0	6350	4200	5100	3060	4450	2670	3200	1710	1900	690
6.0×R0.5 6.0×R1.0	5300	4200	4250	3060	3700	2670	2650	1710	1600	690
8.0×R0.5 8.0×R1.0	4550	4200	3200	3060	2800	2670	2000	1710	1200	690
10.0×R0.5 10.0×R1.0 10.0×R2.0 10.0×R3.0	3200	4200	2550	3060	2250	2670	1600	1710	955	690
12.0×R0.5 12.0×R1.0 12.0×R2.0 12.0×R3.0	2650	4200	2100	3060	1850	2670	1350	1710	795	690
16.0×R1.0 16.0×R2.0 16.0×R3.0	2200	3485	1745	2540	1535	2215	1140	1420	660	570
20.0×R1.0 20.0×R2.0 20.0×R3.0	1825	2895	1450	2110	1275	1840	960	1180	550	475
Maximum cutting depth	Maximum $a_p=0.5\text{mm}$						Maximum $a_p=0.4\text{mm}$		Maximum $a_p=0.2\text{mm}$	
	<p>The diagram illustrates the maximum cutting depth parameters for the end mill. It shows a cross-section of the tool cutting into a workpiece. The axial cutting depth is labeled as $a_e=0.5D$, where D is the diameter of the end mill. The radial cutting depth is labeled as $a_p=0.2R$, where R is the corner radius of the end mill.</p>									

1. Please select high-precision machine and tool holder.
2. Please use air blast or cutting liquid with high mist retardant property.
3. Down milling is recommended.
4. When the machine rigidity and workpiece fixture stability is low, vibration and abnormal noise may be generated. Please reduce the rotating speed and feed speed stated above correspondingly.
5. Make overhang of tool as short as possible in conditions of non-interference.
6. The above cutting parameters are based on contour machining when overhang $L/D \leq 4$. Please make adjustments according to the table below when overhang is different.

Different cutting parameters under different overhang of tool:

Overhang	Cutting speed (m/min)	Axial cutting depth (mm)	Feed speed (mm/min)
$L/D \leq 4$	100%	100%	100%
$L/D=5$	60% ~ 80%	60% ~ 80%	60% ~ 80%
$L/D=6$	40% ~ 60%	40% ~ 60%	40% ~ 60%

UM-4R★UM-4RL(High speed)

Workpiece material	Cast iron, Carbon steel, Alloy steel ~30HRC		Quenched and tempered steel ~40HRC		Quenched and tempered steel ~45HRC		Quenched and tempered steel ~50HRC		Quenched and tempered steel ~55HRC	
	Rotating speed (min ⁻¹)	Feed speed (mm/min)	Rotating speed (min ⁻¹)	Feed speed (mm/min)	Rotating speed (min ⁻¹)	Feed speed (mm/min)	Rotating speed (min ⁻¹)	Feed speed (mm/min)	Rotating speed (min ⁻¹)	Feed speed (mm/min)
4.0×R0.3 4.0×R0.5	16000	7800	16000	7200	12000	5400	12000	4920	7950	2130
5.0×R0.5 5.0×R1.0	12500	8400	12500	7500	9550	5730	9550	5160	6350	2280
6.0×R0.5 6.0×R1.0	10600	8400	10600	7620	7950	5730	7950	5160	5300	2280
8.0×R0.5 8.0×R1.0	7950	8400	7950	7620	5950	5730	5950	5160	4000	2280
10.0×R0.5 10.0×R1.0 10.0×R2.0 10.0×R3.0	6350	8400	6350	7620	4750	5730	4750	5160	3200	2280
12.0×R0.5 12.0×R1.0 12.0×R2.0 12.0×R3.0	5300	8400	5300	7620	4000	5730	4000	5160	2650	2280
16.0×R1.0 16.0×R2.0 16.0×R3.0	3980	6970	3980	6320	2985	4755	2985	4280	1990	1890
20.0×R1.0 20.0×R2.0 20.0×R3.0	3185	5785	3185	5245	2385	3945	2385	3550	1590	1570
Maximum cutting depth	Maximum $a_p=0.4\text{mm}$						Maximum $a_p=0.2\text{mm}$		Maximum $a_p=0.1\text{mm}$	
	<p>The diagram illustrates the maximum cutting depth parameters for a ball nose end mill. It shows a cross-section of the tool cutting into a workpiece. The axial cutting depth is labeled as $a_e=0.3D$, where D is the tool diameter. The radial cutting depth is labeled as $a_p=0.2R$, where R is the tool radius. The workpiece surface is shown with diagonal hatching.</p>									

1. Please select high-precision machine and tool holder.
2. Please use air blow or cutting liquid with high mist retardant property.
3. Down milling is recommended.
4. When the machine rigidity and workpiece fixture stability is low, vibration and abnormal noise may be generated. Please reduce the rotating speed and feed speed stated above correspondingly.
5. Make overhang of tool as short as possible in conditions of non-interference.
6. The above cutting parameters are based on contour machining when overhang $L/D \leq 4$. Please make adjustments according to the table below when overhang is different.

Different cutting parameters under different overhang of tool:

Ratio of neck length to diameter	Cutting speed(m/min)	Axial cutting depth(mm)	Feed speed (mm/min)
$L/D \leq 4$	100%	100%	100%
$L/D=5$	60% ~ 80%	60% ~ 80%	60% ~ 80%
$L/D=6$	40% ~ 60%	40% ~ 60%	40% ~ 60%

Indexable milling tools

Solid carbide end mills

Cutting parameters for UM series end mills

UM-4RFP

Workpiece material	Cast iron, Carbon steel, Alloy steel ~30HRC		Stainless steel		Pre-hardened steel, quenched and tempered steel ~40HRC		Pre-hardened steel, quenched and tempered steel ~50HRC		Hardened steel ~55HRC	
	Diameter (mm)	Rotating speed (min ⁻¹)	Feed speed (mm/min)	Rotating speed (min ⁻¹)	Feed speed (mm/min)	Rotating speed (min ⁻¹)	Feed speed (mm/min)	Rotating speed (min ⁻¹)	Feed speed (mm/min)	Rotating speed (min ⁻¹)
4	10800	1210	5500	210	8000	925	6500	720	5570	530
5	8200	1265	4500	210	6400	965	5000	765	4460	560
6	7000	1295	3700	235	5300	995	4200	780	3710	560
8	5200	1285	2800	235	4000	975	3200	790	2785	580
10	4200	1265	2200	235	3200	965	2500	750	2230	540
12	3500	1265	1850	235	2650	965	2100	750	1855	540
16	2600	1180	1400	210	2000	925	1600	705	1390	520

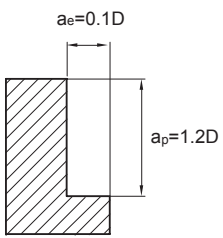
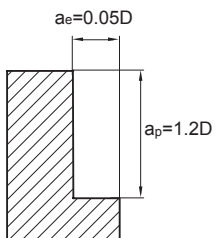
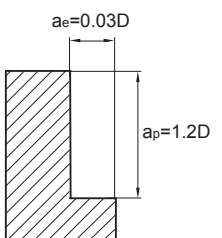
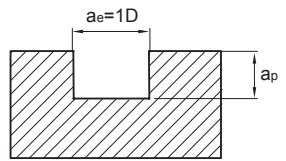
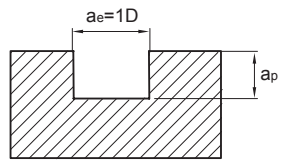
Maximum cutting depth																				
	Diagram	Table	Diagram	Table	Diagram	Table														
		<table border="1"> <thead> <tr> <th>Diameter range</th> <th>Cutting depth a_p</th> </tr> </thead> <tbody> <tr> <td>$\varnothing 1 \leq D < \varnothing 3$</td> <td>0.15D</td> </tr> <tr> <td>$\varnothing 3 \leq D < \varnothing 6$</td> <td>0.3D</td> </tr> <tr> <td>$\varnothing 6 \leq D \leq \varnothing 20$</td> <td>0.5D</td> </tr> </tbody> </table>	Diameter range	Cutting depth a_p	$\varnothing 1 \leq D < \varnothing 3$	0.15D	$\varnothing 3 \leq D < \varnothing 6$	0.3D	$\varnothing 6 \leq D \leq \varnothing 20$	0.5D				<table border="1"> <thead> <tr> <th>Diameter range</th> <th>Cutting depth a_p</th> </tr> </thead> <tbody> <tr> <td>$\varnothing 1 \leq D < \varnothing 3$</td> <td>0.1D</td> </tr> <tr> <td>$\varnothing 3 \leq D$</td> <td>0.2D</td> </tr> </tbody> </table>	Diameter range	Cutting depth a_p	$\varnothing 1 \leq D < \varnothing 3$	0.1D	$\varnothing 3 \leq D$	0.2D
Diameter range	Cutting depth a_p																			
$\varnothing 1 \leq D < \varnothing 3$	0.15D																			
$\varnothing 3 \leq D < \varnothing 6$	0.3D																			
$\varnothing 6 \leq D \leq \varnothing 20$	0.5D																			
Diameter range	Cutting depth a_p																			
$\varnothing 1 \leq D < \varnothing 3$	0.1D																			
$\varnothing 3 \leq D$	0.2D																			

1. The above table shows the standard value of side milling. When milling slot, 50%~70% of rotating speed and 40%~60% of feed speed stated above are recommended as standard.
2. Please select high-precision machine and tool holder.
3. Please use air blow or cutting liquid with high mist retardant property.
4. Down milling is recommended in the case of side milling.
5. When the machine rigidity and workpiece fixture stability is low, vibration and abnormal noise may be generated. Please reduce the rotating speed and feed speed stated above correspondingly.
6. Make overhang of tool as short as possible in conditions of non-interference.

PML-2E★PM-2E★PML-2EL★PM-2EL★PM-2EBL/X

Workpiece material	Cast iron, Carbon steel, Alloy steel ~30HRC		Stainless steel		Pre-hardened steel, quenched and tempered steel ~40HRC		Pre-hardened steel, quenched and tempered steel ~50HRC		Hardened steel ~55HRC	
	Diameter (mm)	Rotating speed (min ⁻¹)	Feed speed (mm/min)	Rotating speed (min ⁻¹)	Feed speed (mm/min)	Rotating speed (min ⁻¹)	Feed speed (mm/min)	Rotating speed (min ⁻¹)	Feed speed (mm/min)	Rotating speed (min ⁻¹)
1	20000	200	20000	60	20000	165	20000	120	20000	90
2	15000	320	11150	85	15000	285	13000	180	11140	130
3	14000	545	7500	120	10600	420	8500	330	7430	240
4	10800	560	5500	135	8000	425	6500	335	5570	245
5	8200	585	4500	135	6400	445	5000	355	4460	260
6	7000	600	3700	140	5300	465	4200	360	3710	260
8	5200	595	2800	140	4000	455	3200	365	2785	270
10	4200	585	2200	140	3200	445	2500	350	2230	250
12	3500	585	1850	140	2650	445	2100	350	1855	250
14	3000	545	1600	135	2300	420	1800	330	1590	240
16	2600	545	1400	120	2000	420	1600	330	1390	240
18	2300	535	1250	120	1800	415	1400	325	1240	235
20	2050	535	1100	120	1600	415	1250	325	1115	235

Maximum cutting depth	Diagram 1: $a_e=0.1D$		Diagram 2: $a_e=0.05D$		Diagram 3: $a_e=0.03D$													
	$a_p=1.5D$	$a_p=1.5D$	$a_p=1.5D$	$a_p=1.5D$	$a_p=1.5D$	$a_p=1.5D$												
Diagram 4: $a_e=1D$	<table border="1"> <thead> <tr> <th>Diameter range</th> <th>Cutting depth a_p</th> </tr> </thead> <tbody> <tr> <td>$\varnothing 1 \leq D < \varnothing 3$</td> <td>0.15D</td> </tr> <tr> <td>$\varnothing 3 \leq D < \varnothing 6$</td> <td>0.3D</td> </tr> <tr> <td>$\varnothing 6 \leq D < \varnothing 20$</td> <td>0.5D</td> </tr> </tbody> </table>		Diameter range	Cutting depth a_p	$\varnothing 1 \leq D < \varnothing 3$	0.15D	$\varnothing 3 \leq D < \varnothing 6$	0.3D	$\varnothing 6 \leq D < \varnothing 20$	0.5D	<table border="1"> <thead> <tr> <th>Diameter range</th> <th>Cutting depth a_p</th> </tr> </thead> <tbody> <tr> <td>$\varnothing 1 \leq D < \varnothing 3$</td> <td>0.1D</td> </tr> <tr> <td>$\varnothing 3 \leq D$</td> <td>0.2D</td> </tr> </tbody> </table>		Diameter range	Cutting depth a_p	$\varnothing 1 \leq D < \varnothing 3$	0.1D	$\varnothing 3 \leq D$	0.2D
	Diameter range	Cutting depth a_p																
$\varnothing 1 \leq D < \varnothing 3$	0.15D																	
$\varnothing 3 \leq D < \varnothing 6$	0.3D																	
$\varnothing 6 \leq D < \varnothing 20$	0.5D																	
Diameter range	Cutting depth a_p																	
$\varnothing 1 \leq D < \varnothing 3$	0.1D																	
$\varnothing 3 \leq D$	0.2D																	

- The above table shows the standard value of side milling. When milling slot, 50%~70% of rotating speed and 40%~60% of feed speed stated above are recommended as standard.
- Please select high-precision machine and tool holder.
- Please use air blow or cutting liquid with high mist retardant property.
- Down milling is recommended in the case of side milling.
- When the machine rigidity and workpiece fixture stability is low, vibration and abnormal noise may be generated. Please reduce the rotating speed and feed speed stated above correspondingly.
- Make overhang of tool as short as possible in conditions of non-interference.

Indexable milling tools

Solid carbide end mills

Cutting parameters for PML/PM series end mills

PML-2F★PM-2F★PML-2FL★PM-2FL

Workpiece material	Cast iron, Carbon steel, Alloy steel ~30HRC		Stainless steel		Pre-hardened steel, quenched and tempered steel ~40HRC		Pre-hardened steel, quenched and tempered steel ~50HRC		Hardened steel ~55HRC	
	Diameter (mm)	Rotating speed (min ⁻¹)	Feed speed (mm/min)	Rotating speed (min ⁻¹)	Feed speed (mm/min)	Rotating speed (min ⁻¹)	Feed speed (mm/min)	Rotating speed (min ⁻¹)	Feed speed (mm/min)	Rotating speed (min ⁻¹)
1	20000	140	20000	45	20000	115	20000	85	20000	65
2	15000	225	11150	60	15000	200	13000	125	11140	90
3	14000	385	7500	85	10600	295	8500	230	7430	170
4	10800	390	5500	95	8000	300	6500	235	5570	170
5	8200	410	4500	95	6400	315	5000	245	4460	180
6	7000	420	3700	95	5300	325	4200	255	3710	180
8	5200	415	2800	95	4000	320	3200	255	2785	190
10	4200	410	2200	95	3200	315	2500	240	2230	175
12	3500	410	1850	95	2650	315	2100	240	1855	175
14	3000	385	1600	95	2300	295	1800	230	1590	170
16	2600	385	1400	85	2000	295	1600	230	1390	170
18	2300	375	1250	85	1800	290	1400	230	1240	165
20	2050	375	1100	85	1600	290	1250	230	1115	165

Maximum cutting depth	Diagram 1: $a_e=0.1D$		Diagram 2: $a_e=0.05D$		Diagram 3: $a_e=0.03D$																					
	a_p	Table	a_p	Table	a_p	Table																				
	$a_p=1.5D$		$a_p=1.5D$		$a_p=1.5D$																					
	a_p	<table border="1"> <thead> <tr><th>Diameter range</th><th>Cutting depth a_p</th></tr> </thead> <tbody> <tr><td>$\varnothing 1 \leq D < \varnothing 3$</td><td>0.15D</td></tr> <tr><td>$\varnothing 3 \leq D < \varnothing 6$</td><td>0.3D</td></tr> <tr><td>$\varnothing 6 \leq D < \varnothing 20$</td><td>0.5D</td></tr> </tbody> </table>	Diameter range	Cutting depth a_p	$\varnothing 1 \leq D < \varnothing 3$	0.15D	$\varnothing 3 \leq D < \varnothing 6$	0.3D	$\varnothing 6 \leq D < \varnothing 20$	0.5D	a_p	<table border="1"> <thead> <tr><th>Diameter range</th><th>Cutting depth a_p</th></tr> </thead> <tbody> <tr><td>$\varnothing 1 \leq D < \varnothing 3$</td><td>0.1D</td></tr> <tr><td>$\varnothing 3 \leq D$</td><td>0.2D</td></tr> </tbody> </table>	Diameter range	Cutting depth a_p	$\varnothing 1 \leq D < \varnothing 3$	0.1D	$\varnothing 3 \leq D$	0.2D	a_p	<table border="1"> <thead> <tr><th>Diameter range</th><th>Cutting depth a_p</th></tr> </thead> <tbody> <tr><td>$\varnothing 1 \leq D < \varnothing 3$</td><td>0.1D</td></tr> <tr><td>$\varnothing 3 \leq D$</td><td>0.2D</td></tr> </tbody> </table>	Diameter range	Cutting depth a_p	$\varnothing 1 \leq D < \varnothing 3$	0.1D	$\varnothing 3 \leq D$	0.2D
Diameter range	Cutting depth a_p																									
$\varnothing 1 \leq D < \varnothing 3$	0.15D																									
$\varnothing 3 \leq D < \varnothing 6$	0.3D																									
$\varnothing 6 \leq D < \varnothing 20$	0.5D																									
Diameter range	Cutting depth a_p																									
$\varnothing 1 \leq D < \varnothing 3$	0.1D																									
$\varnothing 3 \leq D$	0.2D																									
Diameter range	Cutting depth a_p																									
$\varnothing 1 \leq D < \varnothing 3$	0.1D																									
$\varnothing 3 \leq D$	0.2D																									

- The above table shows the standard value of side milling. When milling slot, 50%~70% of rotating speed and 40%~60% of feed speed stated above are recommended as standard.
- Please select high-precision machine and tool holder.
- Please use air blow or cutting liquid with high mist retardant property.
- Down milling is recommended in the case of side milling.
- When the machine rigidity and workpiece fixture stability is low, vibration and abnormal noise may be generated. Please reduce the rotating speed and feed speed stated above correspondingly.
- Make overhang of tool as short as possible in conditions of non-interference.

PML-2EFP★PM-2EFP

Workpiece material	Cast iron, Carbon steel, Alloy steel ~30HRC		Stainless steel		Pre-hardened steel, quenched and tempered steel ~40HRC		Pre-hardened steel, quenched and tempered steel ~50HRC		Hardened steel ~55HRC			
	Diameter (mm)	Rotating speed (min ⁻¹)	Feed speed (mm/min)	Rotating speed (min ⁻¹)	Feed speed (mm/min)	Rotating speed (min ⁻¹)	Feed speed (mm/min)	Rotating speed (min ⁻¹)	Feed speed (mm/min)	Rotating speed (min ⁻¹)	Feed speed (mm/min)	
6	7000	780	3700	180	5300	600	4200	470	3710	340		
8	5200	775	2800	180	4000	595	3200	475	2785	350		
10	4200	755	2200	180	3200	575	2500	455	2230	325		
12	3500	755	1850	180	2650	575	2100	455	1855	325		
16	2600	710	1400	155	2000	545	1600	425	1390	310		
20	2050	700	1100	155	1600	540	1250	420	1115	305		
Maximum cutting depth												

- The above table shows the standard value of side milling. When milling slot, 50%~70% of rotating speed and 40%~60% of feed speed stated above are recommended as standard.
- Please select high-precision machine and tool holder.
- Please use air blow or cutting liquid with high mist retardant property.
- Down milling is recommended in the case of side milling.
- When the machine rigidity and workpiece fixture stability is low, vibration and abnormal noise may be generated. Please reduce the rotating speed and feed speed stated above correspondingly.
- Make overhang of tool as short as possible in conditions of non-interference.

PML-3E-H★PM-3E-H★PML-3EL-H★PM-3EL-H

Workpiece material	Cast iron, Carbon steel, Alloy steel ~30HRC		Stainless steel		Pre-hardened steel, quenched and tempered steel ~40HRC		Pre-hardened steel, quenched and tempered steel ~50HRC		Hardened steel ~55HRC	
	Diameter (mm)	Rotating speed (min ⁻¹)	Feed speed (mm/min)	Rotating speed (min ⁻¹)	Feed speed (mm/min)	Rotating speed (min ⁻¹)	Feed speed (mm/min)	Rotating speed (min ⁻¹)	Feed speed (mm/min)	Rotating speed (min ⁻¹)
1	20000	200	20000	75	20000	160	20000	100	20000	90
2	15000	325	11150	80	15000	285	13000	150	11140	130
3	14000	550	7500	100	10600	425	8500	280	7430	245
4	10800	565	5500	105	8000	430	6500	285	5570	250
5	8200	600	4500	105	6400	455	5000	300	4460	260
6	7000	605	3700	110	5300	465	4200	305	3710	260
8	5200	600	2800	110	4000	460	3200	310	2785	275
10	4200	600	2200	110	3200	455	2500	290	2230	255
12	3500	600	1850	110	2650	455	2100	290	1855	255
14	3000	550	1600	105	2300	425	1800	280	1590	245
16	2600	550	1400	100	2000	425	1600	280	1390	245
18	2300	540	1250	85	1800	415	1400	275	1240	240
20	2050	540	1100	85	1600	415	1250	275	1115	240

Maximum cutting depth	Diagram 1: $a_e=0.1D$		Diagram 2: $a_e=0.05D$		Diagram 3: $a_e=0.03D$	
	a_p	Value	a_p	Value	a_p	Value
		$1.5D$		$1.5D$		$1.5D$

Diagram 4: $a_e=1D$	Table 1	Table 2														
	<table border="1"> <thead> <tr> <th>Diameter range</th> <th>Cutting depth a_p</th> </tr> </thead> <tbody> <tr><td>$\varnothing 1 \leq D < \varnothing 3$</td><td>0.15D</td></tr> <tr><td>$\varnothing 3 \leq D < \varnothing 6$</td><td>0.3D</td></tr> <tr><td>$\varnothing 6 \leq D < \varnothing 20$</td><td>0.5D</td></tr> </tbody> </table>	Diameter range	Cutting depth a_p	$\varnothing 1 \leq D < \varnothing 3$	0.15D	$\varnothing 3 \leq D < \varnothing 6$	0.3D	$\varnothing 6 \leq D < \varnothing 20$	0.5D	<table border="1"> <thead> <tr> <th>Diameter range</th> <th>Cutting depth a_p</th> </tr> </thead> <tbody> <tr><td>$\varnothing 1 \leq D < \varnothing 3$</td><td>0.1D</td></tr> <tr><td>$\varnothing 3 \leq D$</td><td>0.2D</td></tr> </tbody> </table>	Diameter range	Cutting depth a_p	$\varnothing 1 \leq D < \varnothing 3$	0.1D	$\varnothing 3 \leq D$	0.2D
Diameter range	Cutting depth a_p															
$\varnothing 1 \leq D < \varnothing 3$	0.15D															
$\varnothing 3 \leq D < \varnothing 6$	0.3D															
$\varnothing 6 \leq D < \varnothing 20$	0.5D															
Diameter range	Cutting depth a_p															
$\varnothing 1 \leq D < \varnothing 3$	0.1D															
$\varnothing 3 \leq D$	0.2D															

- The above table shows the standard value of side milling. When milling slot, 50%~70% of rotating speed and 40%~60% of feed speed stated above are recommended as standard.
- Please select high-precision machine and tool holder.
- Please use air blow or cutting liquid with high mist retardant property.
- Down milling is recommended in the case of side milling.
- When the machine rigidity and workpiece fixture stability is low, vibration and abnormal noise may be generated. Please reduce the rotating speed and feed speed stated above correspondingly.
- Make overhang of tool as short as possible in conditions of non-interference.

PML-4E-G★PM-4E-G★PML-4EL-G★PM-4EL-G★PM-4EBL/X-G PML-4E-H★PM-4E-H★PML-4EL-H★PM-4EL-H(general cutting)

Workpiece material	Cast iron, Carbon steel, Alloy steel ~30HRC		Stainless steel		Pre-hardened steel, quenched and tempered steel ~40HRC		Pre-hardened steel, quenched and tempered steel ~50HRC		Hardened steel ~55HRC	
	Diameter (mm)	Rotating speed (min ⁻¹)	Feed speed (mm/min)	Rotating speed (min ⁻¹)	Feed speed (mm/min)	Rotating speed (min ⁻¹)	Feed speed (mm/min)	Rotating speed (min ⁻¹)	Feed speed (mm/min)	Rotating speed (min ⁻¹)
1	20000	270	20000	95	20000	215	20000	135	20000	120
2	15000	435	11150	110	15000	380	13000	200	11140	175
3	14000	735	7500	135	10600	565	8500	370	7430	325
4	10800	755	5500	140	8000	575	6500	380	5570	335
5	8200	795	4500	140	6400	605	5000	400	4460	350
6	7000	810	3700	145	5300	620	4200	405	3710	350
8	5200	800	2800	145	4000	615	3200	415	2785	365
10	4200	795	2200	145	3200	605	2500	390	2230	340
12	3500	795	1850	145	2650	605	2100	390	1855	340
14	3000	735	1600	140	2300	565	1800	370	1590	325
16	2600	735	1400	135	2000	565	1600	370	1390	325
18	2300	720	1250	115	1800	555	1400	365	1240	315
20	2050	720	1100	115	1600	555	1250	365	1115	315

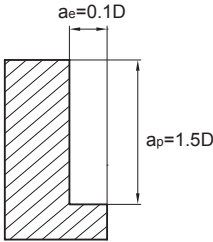
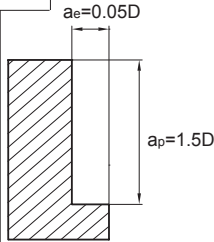
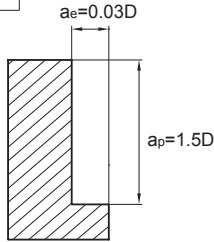
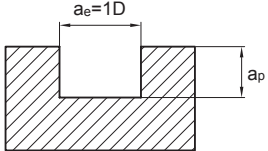
Maximum cutting depth	Diagram 1: $a_e=0.1D$		Diagram 2: $a_e=0.05D$		Diagram 3: $a_e=0.03D$																							
	a_p	Table	a_p	Table	a_p	Table																						
	1.5D	<table border="1"> <thead> <tr><th>Diameter range</th><th>Cutting depth a_p</th></tr> </thead> <tbody> <tr><td>$\varnothing 1 \leq D < \varnothing 3$</td><td>0.15D</td></tr> <tr><td>$\varnothing 3 \leq D < \varnothing 6$</td><td>0.3D</td></tr> <tr><td>$\varnothing 6 \leq D < \varnothing 20$</td><td>0.5D</td></tr> </tbody> </table>	Diameter range	Cutting depth a_p	$\varnothing 1 \leq D < \varnothing 3$	0.15D	$\varnothing 3 \leq D < \varnothing 6$	0.3D	$\varnothing 6 \leq D < \varnothing 20$	0.5D		1.5D	<table border="1"> <thead> <tr><th>Diameter range</th><th>Cutting depth a_p</th></tr> </thead> <tbody> <tr><td>$\varnothing 1 \leq D < \varnothing 3$</td><td>0.1D</td></tr> <tr><td>$\varnothing 3 \leq D$</td><td>0.2D</td></tr> </tbody> </table>	Diameter range	Cutting depth a_p	$\varnothing 1 \leq D < \varnothing 3$	0.1D	$\varnothing 3 \leq D$	0.2D		1.5D	<table border="1"> <thead> <tr><th>Diameter range</th><th>Cutting depth a_p</th></tr> </thead> <tbody> <tr><td>$\varnothing 1 \leq D < \varnothing 3$</td><td>0.1D</td></tr> <tr><td>$\varnothing 3 \leq D$</td><td>0.2D</td></tr> </tbody> </table>	Diameter range	Cutting depth a_p	$\varnothing 1 \leq D < \varnothing 3$	0.1D	$\varnothing 3 \leq D$	0.2D
	Diameter range	Cutting depth a_p																										
	$\varnothing 1 \leq D < \varnothing 3$	0.15D																										
$\varnothing 3 \leq D < \varnothing 6$	0.3D																											
$\varnothing 6 \leq D < \varnothing 20$	0.5D																											
Diameter range	Cutting depth a_p																											
$\varnothing 1 \leq D < \varnothing 3$	0.1D																											
$\varnothing 3 \leq D$	0.2D																											
Diameter range	Cutting depth a_p																											
$\varnothing 1 \leq D < \varnothing 3$	0.1D																											
$\varnothing 3 \leq D$	0.2D																											
	a_p	<table border="1"> <thead> <tr><th>Diameter range</th><th>Cutting depth a_p</th></tr> </thead> <tbody> <tr><td>$\varnothing 1 \leq D < \varnothing 3$</td><td>0.15D</td></tr> <tr><td>$\varnothing 3 \leq D < \varnothing 6$</td><td>0.3D</td></tr> <tr><td>$\varnothing 6 \leq D < \varnothing 20$</td><td>0.5D</td></tr> </tbody> </table>	Diameter range	Cutting depth a_p	$\varnothing 1 \leq D < \varnothing 3$	0.15D	$\varnothing 3 \leq D < \varnothing 6$	0.3D	$\varnothing 6 \leq D < \varnothing 20$	0.5D																		
	Diameter range	Cutting depth a_p																										
	$\varnothing 1 \leq D < \varnothing 3$	0.15D																										
$\varnothing 3 \leq D < \varnothing 6$	0.3D																											
$\varnothing 6 \leq D < \varnothing 20$	0.5D																											

- The above table shows the standard value of side milling. When milling slot, 50%~70% of rotating speed and 40%~60% of feed speed stated above are recommended as standard.
- Please select high-precision machine and tool holder.
- Please use air blow or cutting liquid with high mist retardant property.
- Down milling is recommended in the case of side milling.
- When the machine rigidity and workpiece fixture stability is low, vibration and abnormal noise may be generated. Please reduce the rotating speed and feed speed stated above correspondingly.
- Make overhang of tool as short as possible in conditions of non-interference.

Indexable milling tools

Solid carbide end mills

Cutting parameters for PML/PM series end mills

PML-4E-G★PM-4E-G★PML-4EL-G★PM-4EL-G★PM-4EBL/X-G PML-4E-H★PM-4E-H★PML-4EL-H★PM-4EL-H(high speed side milling)

Workpiece material	Cast iron, Carbon steel, Alloy steel ~30HRC		Carbon steel, Alloy steel ~40HRC		Pre-hardened steel, quenched and tempered steel ~45HRC		Pre-hardened steel, quenched and tempered steel ~50HRC		Hardened steel ~55HRC	
Cutting speed	300m/min		250 m/min		200 m/min		150 m/min		100 m/min	
Diameter (mm)	Rotating speed (min ⁻¹)	Feed speed (mm/min)	Rotating speed (min ⁻¹)	Feed speed (mm/min)	Rotating speed (min ⁻¹)	Feed speed (mm/min)	Rotating speed (min ⁻¹)	Feed speed (mm/min)	Rotating speed (min ⁻¹)	Feed speed (mm/min)
6	15915	1535	13260	1280	10600	1020	7960	765	5300	515
8	11935	1530	9950	1260	7960	1020	5970	765	3980	515
10	9550	1450	7960	1245	6370	1000	4775	750	3180	495
12	7960	1450	6630	1245	5300	1000	3980	750	2650	495
14	6820	1390	5685	1160	4550	930	3410	810	2275	465
16	5970	1390	4975	1160	3980	930	2985	810	1990	465
18	5305	1390	4420	1160	3540	930	2650	810	1770	465
20	4775	1390	3980	1160	3180	930	2390	810	1590	465

Maximum cutting depth		

1. Please select high-precision machine and tool holder.
2. Please use air blow or MQL (minimum oil mist cooling).
3. Down milling is recommended in the case of side milling.
4. When the machine rigidity and workpiece fixture stability is low, vibration and abnormal noise may be generated. Please reduce the rotating speed and feed speed stated above correspondingly.
5. Make overhang of tool as short as possible in conditions of non-interference.

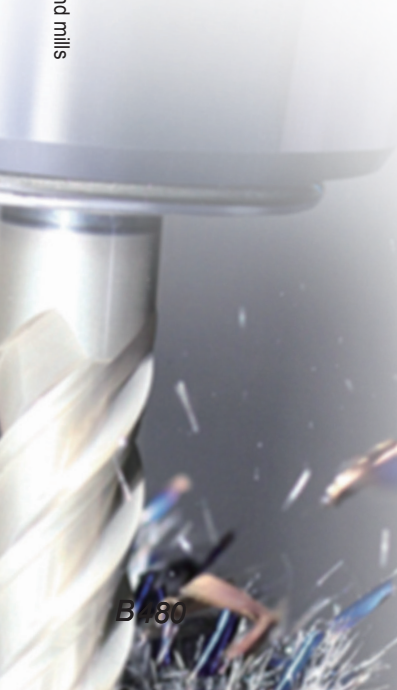

PML-4F-G★PM-4F-G★PML-4FL-G★PM-4FL-G(general cutting)

Workpiece material	Cast iron, Carbon steel, Alloy steel ~30HRC		Carbon steel, Alloy steel ~40HRC		Pre-hardened steel, quenched and tempered steel ~45HRC		Pre-hardened steel, quenched and tempered steel ~50HRC		Hardened steel ~55HRC	
	Diameter (mm)	Rotating speed (min ⁻¹)	Feed speed (mm/min)	Rotating speed (min ⁻¹)	Feed speed (mm/min)	Rotating speed (min ⁻¹)	Feed speed (mm/min)	Rotating speed (min ⁻¹)	Feed speed (mm/min)	Rotating speed (min ⁻¹)
1	20000	190	20000	70	20000	150	20000	95	20000	85
2	15000	305	11150	80	15000	265	13000	140	11140	125
3	14000	515	7500	95	10600	395	8500	260	7430	230
4	10800	530	5500	100	8000	4055	6500	265	5570	235
5	8200	555	4500	100	6400	425	5000	280	4460	245
6	7000	570	3700	100	5300	435	4200	283	3710	245
8	5200	560	2800	100	4000	430	3200	290	2785	255
10	4200	555	2200	100	3200	425	2500	275	2230	240
12	3500	555	1850	100	2650	425	2100	275	1855	240
14	3000	515	1600	100	2300	395	1800	260	1590	230
16	2600	515	1400	95	2000	395	1600	260	1390	230
18	2300	505	1250	80	1800	390	1400	255	1240	220
20	2050	505	1100	80	1600	390	1250	255	1115	220

Maximum cutting depth	Diagram 1: $a_e=0.1D$, $a_p=1.5D$		Diagram 2: $a_e=0.05D$, $a_p=1.5D$		Diagram 3: $a_e=0.03D$, $a_p=1.5D$	

Diagram 4: $a_e=1D$, a_p	Diameter range	Cutting depth a_p
	$\varnothing 1 \leq D < \varnothing 3$	0.15D
	$\varnothing 3 \leq D < \varnothing 6$	0.3D
	$\varnothing 6 \leq D < \varnothing 20$	0.5D

Diagram 5: $a_e=0.05D$, $a_p=1.5D$	Diameter range	Cutting depth a_p
	$\varnothing 1 \leq D < \varnothing 3$	0.1D
	$\varnothing 3 \leq D$	0.2D

Indexable milling tools

Solid carbide end mills

Cutting parameters for PML/PM series end mills

- The above table shows the standard value of side milling. When milling slot, 50%~70% of rotating speed and 40%~60% of feed speed stated above are recommended as standard.
- Please select high-precision machine and tool holder.
- Please use air blow or cutting liquid with high mist retardant property.
- Down milling is recommended in the case of side milling.
- When the machine rigidity and workpiece fixture stability is low, vibration and abnormal noise may be generated. Please reduce the rotating speed and feed speed stated above correspondingly.
- Make overhang of tool as short as possible in conditions of non-interference.

PML-4F-G★PM-4F-G★PML-4FL-G★PM-4FL-G(high speed side milling)

Workpiece material	Cast iron, Carbon steel, Alloy steel ~30HRC		Carbon steel, Alloy steel ~40HRC		Pre-hardened steel, quenched and tempered steel ~45HRC		Pre-hardened steel, quenched and tempered steel ~50HRC		Hardened steel ~55HRC		
Cutting speed	300m/min		250 m/min		200 m/min		150 m/min		100 m/min		
Diameter (mm)	Rotating speed (min ⁻¹)	Feed speed (mm/min)	Rotating speed (min ⁻¹)	Feed speed (mm/min)	Rotating speed (min ⁻¹)	Feed speed (mm/min)	Rotating speed (min ⁻¹)	Feed speed (mm/min)	Rotating speed (min ⁻¹)	Feed speed (mm/min)	
6	15915	1075	13260	900	10600	715	7960	535	5300	360	
8	11935	1070	9950	885	7960	715	5970	535	3980	360	
10	9550	1015	7960	870	6370	700	4775	525	3180	345	
12	7960	1015	6630	870	5300	700	3980	525	2650	345	
14	6820	975	5685	815	4550	650	3410	570	2275	325	
16	5970	975	4975	815	3980	650	2985	570	1990	325	
18	5305	975	4420	815	3540	650	2650	570	1770	325	
20	4775	975	3980	815	3180	650	2390	570	1590	325	
Maximum cutting depth											

1. Please select high-precision machine and tool holder.
2. Please use air blow or MQL(minimum oil mist cooling).
3. Down milling is recommended in the case of side milling.
4. When the machine rigidity and workpiece fixture stability is low, vibration and abnormal noise may be generated. Please reduce the rotating speed and feed speed stated above correspondingly.
5. Make overhang of tool as short as possible in conditions of non-interference.

PML-4EX-G★PM-4EX-G

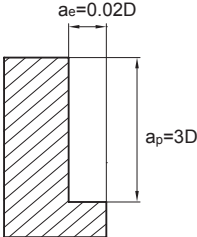
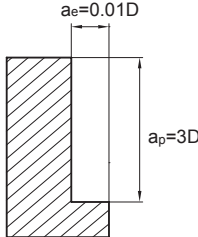
Workpiece material	Cast iron, Carbon steel, Alloy steel ~30HRC		Stainless steel		Pre-hardened steel, quenched and tempered steel ~40HRC		Pre-hardened steel, quenched and tempered steel ~50HRC		Hardened steel ~55HRC		
	Diameter (mm)	Rotating speed (min ⁻¹)	Feed speed (mm/min)	Rotating speed (min ⁻¹)	Feed speed (mm/min)	Rotating speed (min ⁻¹)	Feed speed (mm/min)	Rotating speed (min ⁻¹)	Feed speed (mm/min)	Rotating speed (min ⁻¹)	Feed speed (mm/min)
6	5800	570	2650	85	4250	410	3600	345	3180	305	
8	4400	570	2000	85	3180	410	2700	350	2390	310	
10	3500	555	1600	85	2550	400	2150	340	1910	300	
12	2900	555	1350	85	2120	400	1800	340	1590	300	
16	2200	520	1000	80	1590	380	1350	315	1195	280	
20	1750	510	800	75	1270	375	1050	310	955	280	
Maximum cutting depth											

1. Please select high-precision machine and tool holder.
2. Please use air blow or cutting liquid with high mist retardant property.
3. Down milling is recommended in the case of side milling.
4. When the machine rigidity and workpiece fixture stability is low, vibration and abnormal noise may be generated. Please reduce the rotating speed and feed speed stated above correspondingly.
5. Make overhang of tool as short as possible in conditions of non-interference.

PML-4E★PM-4E★PML-4EL★PM-4EL★PM-4EBL/X(general cutting)

Workpiece material	Cast iron, Carbon steel, Alloy steel ~30HRC		Stainless steel		Pre-hardened steel, quenched and tempered steel ~40HRC		Pre-hardened steel, quenched and tempered steel ~50HRC		Hardened steel ~55HRC	
	Diameter (mm)	Rotating speed (min ⁻¹)	Feed speed (mm/min)	Rotating speed (min ⁻¹)	Feed speed (mm/min)	Rotating speed (min ⁻¹)	Feed speed (mm/min)	Rotating speed (min ⁻¹)	Feed speed (mm/min)	Rotating speed (min ⁻¹)
1	20000	300	20000	108	20000	240	20000	180	20000	135
2	15000	480	11150	120	15000	420	13000	270	11140	195
3	14000	815	7500	145	10600	630	8500	495	7430	360
4	10800	840	5500	150	8000	645	6500	505	5570	370
5	8200	875	4500	150	6400	675	5000	530	4460	390
6	7000	900	3700	165	5300	690	4200	540	3710	390
8	5200	890	2800	165	4000	680	3200	555	2785	405
10	4200	875	2200	165	3200	675	2500	525	2230	375
12	3500	875	1850	165	2650	675	2100	525	1855	375
14	3000	815	1600	150	2300	630	1800	495	1590	360
16	2600	815	1400	145	2000	630	1600	495	1390	360
18	2300	805	1250	125	1800	620	1400	485	1240	350
20	2050	805	1100	125	1600	620	1250	485	1115	350

Maximum cutting depth	Diagram 1: $a_e=0.1D$, $a_p=1.5D$		Diagram 2: $a_e=0.05D$, $a_p=1.5D$		Diagram 3: $a_e=0.03D$, $a_p=1.5D$	

Diagram 4: $a_e=1D$, a_p	Diameter range	Cutting depth a_p
	$\varnothing 1 \leq D < \varnothing 3$	0.15D
	$\varnothing 3 \leq D < \varnothing 6$	0.3D
	$\varnothing 6 \leq D < \varnothing 20$	0.5D

Diameter range	Cutting depth a_p
$\varnothing 1 \leq D < \varnothing 3$	0.1D
$\varnothing 3 \leq D$	0.2D

- The above table shows the standard value of side milling. When milling slot, 50%~70% of rotating speed and 40%~60% of feed speed stated above are recommended as standard.
- Please select high-precision machine and tool holder.
- Please use air blow or cutting liquid with high mist retardant property.
- Down milling is recommended in the case of side milling.
- When the machine rigidity and workpiece fixture stability is low, vibration and abnormal noise may be generated. Please reduce the rotating speed and feed speed stated above correspondingly.
- Make overhang of tool as short as possible in conditions of non-interference.

PML-4E★PM-4E★PML-4EL★PM-4EL★PM-4EBL/X(high speed side milling)

Workpiece material	Cast iron, Carbon steel, Alloy steel ~30HRC		Carbon steel, Alloy steel ~40HRC		Pre-hardened steel, quenched and tempered steel ~45HRC		Pre-hardened steel, quenched and tempered steel ~50HRC		Hardened steel ~55HRC		
Cutting speed	300m/min		250 m/min		200 m/min		150 m/min		100 m/min		
Diameter (mm)	Rotating speed (min ⁻¹)	Feed speed (mm/min)	Rotating speed (min ⁻¹)	Feed speed (mm/min)	Rotating speed (min ⁻¹)	Feed speed (mm/min)	Rotating speed (min ⁻¹)	Feed speed (mm/min)	Rotating speed (min ⁻¹)	Feed speed (mm/min)	
6	15915	1705	13260	1420	10600	1135	7960	850	5300	570	
8	11935	1700	9950	1400	7960	1130	5970	850	3980	570	
10	9550	1660	7960	1380	6370	1110	4775	830	3180	550	
12	7960	1660	6630	1380	5300	1110	3980	830	2650	550	
14	6820	1545	5685	1290	4550	1030	3410	900	2275	515	
16	5970	1545	4975	1290	3980	1030	2985	900	1990	515	
18	5305	1545	4420	1290	3540	1030	2650	900	1770	515	
20	4775	1545	3980	1290	3180	1030	2390	900	1590	515	
Maximum cutting depth											

1. Please select high-precision machine and tool holder.
2. Please use air blow or MQL (minimum oil mist cooling).
3. Down milling is recommended in the case of side milling.
4. When the machine rigidity and workpiece fixture stability is low, vibration and abnormal noise may be generated. Please reduce the rotating speed and feed speed stated above correspondingly.
5. Make overhang of tool as short as possible in conditions of non-interference.

PML-4EFP★PM-4EFP(general cutting)

Workpiece material	Cast iron, Carbon steel, Alloy steel ~30HRC		Stainless steel		Pre-hardened steel, quenched and tempered steel ~40HRC		Pre-hardened steel, quenched and tempered steel ~50HRC		Hardened steel ~55HRC	
	Diameter (mm)	Rotating speed (min ⁻¹)	Feed speed (mm/min)	Rotating speed (min ⁻¹)	Feed speed (mm/min)	Rotating speed (min ⁻¹)	Feed speed (mm/min)	Rotating speed (min ⁻¹)	Feed speed (mm/min)	Rotating speed (min ⁻¹)
6	7000	1170	3700	210	5300	900	4200	705	3710	510
8	5200	1155	2800	210	4000	885	3200	720	2785	525
10	4200	1140	2200	210	3200	875	2500	680	2230	490
12	3500	1140	1850	210	2650	875	2100	680	1855	490
16	2600	1065	1400	185	2000	815	1600	645	1390	470
20	2050	1045	1100	165	1600	805	1250	630	1115	455

Maximum cutting depth			

- The above table shows the standard value of side milling. When milling slot, 50%~70% of rotating speed and 40%~60% of feed speed stated above are recommended as standard.
- Please select high-precision machine and tool holder.
- Please use air blow or cutting liquid with high mist retardant property.
- Down milling is recommended in the case of side milling.
- When the machine rigidity and workpiece fixture stability is low, vibration and abnormal noise may be generated. Please reduce the rotating speed and feed speed stated above correspondingly.
- Make overhang of tool as short as possible in conditions of non-interference.

Indexable milling tools

Solid carbide end mills

Cutting parameters for PML/PM series end mills

PML-4EFP★PM-4EFP(high speed side milling)

Workpiece material	Cast iron, Carbon steel, Alloy steel ~30HRC		Carbon steel, Alloy steel ~40HRC		Pre-hardened steel, quenched and tempered steel ~45HRC		Pre-hardened steel, quenched and tempered steel ~50HRC		Hardened steel ~55HRC		
Cutting speed	300m/min		250 m/min		200 m/min		150 m/min		100 m/min		
Diameter (mm)	Rotating speed (min ⁻¹)	Feed speed (mm/min)	Rotating speed (min ⁻¹)	Feed speed (mm/min)	Rotating speed (min ⁻¹)	Feed speed (mm/min)	Rotating speed (min ⁻¹)	Feed speed (mm/min)	Rotating speed (min ⁻¹)	Feed speed (mm/min)	
6	15915	2215	13260	1845	10600	1475	7960	1105	5300	740	
8	11935	2210	9950	1820	7960	1470	5970	1080	3980	740	
10	9550	2160	7960	1795	6370	1445	4775	1080	3180	715	
12	7960	2160	6630	1795	5300	1445	3980	1170	2650	715	
16	5970	2010	4975	1680	3980	1340	2985	1170	1990	670	
20	4775	2010	3980	1980	3180	1340	2390	1105	1590	670	
Maximum cutting depth											

1. Please select high-precision machine and tool holder.
2. Please use air blow or MQL (minimum oil mist cooling).
3. Down milling is recommended in the case of side milling.
4. When the machine rigidity and workpiece fixture stability is low, vibration and abnormal noise may be generated. Please reduce the rotating speed and feed speed stated above correspondingly.
5. Make overhang of tool as short as possible in conditions of non-interference.

PML-6E★PM-6E

Workpiece material	Cast iron, Carbon steel, Alloy steel ~30HRC		Stainless steel		Pre-hardened steel, quenched and tempered steel ~40HRC		Pre-hardened steel, quenched and tempered steel ~50HRC		Hardened steel ~55HRC		
	Diameter (mm)	Rotating speed (min ⁻¹)	Feed speed (mm/min)	Rotating speed (min ⁻¹)	Feed speed (mm/min)	Rotating speed (min ⁻¹)	Feed speed (mm/min)	Rotating speed (min ⁻¹)	Feed speed (mm/min)	Rotating speed (min ⁻¹)	Feed speed (mm/min)
6	7000	1070	3700	195	5300	815	4200	650	3710	470	
8	5200	1070	2800	195	4000	815	3200	660	2785	485	
10	4200	1035	2200	195	3200	800	2500	630	2230	450	
12	3500	1035	1850	195	2650	800	2100	630	1855	450	
16	2600	975	1400	180	2000	750	1600	590	1390	435	
20	2050	960	1100	150	1600	740	1250	580	1115	420	
Maximum cutting depth											

1. Please select high-precision machine and tool holder.
2. Please use air blow or cutting liquid with high mist retardant property.
3. Down milling is recommended in the case of side milling.
4. When the machine rigidity and workpiece fixture stability is low, vibration and abnormal noise may be generated. Please reduce the rotating speed and feed speed stated above correspondingly.
5. Make overhang of tool as short as possible in conditions of non-interference.

PML-6EL★PM-6EL

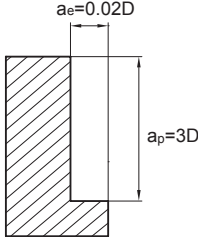
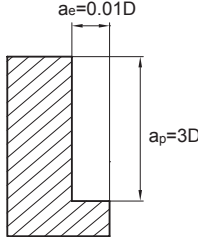
Workpiece material	Cast iron, Carbon steel, Alloy steel ~30HRC		Stainless steel		Pre-hardened steel, quenched and tempered steel ~40HRC		Pre-hardened steel, quenched and tempered steel ~50HRC		Hardened steel ~55HRC		
	Diameter (mm)	Rotating speed (min ⁻¹)	Feed speed (mm/min)	Rotating speed (min ⁻¹)	Feed speed (mm/min)	Rotating speed (min ⁻¹)	Feed speed (mm/min)	Rotating speed (min ⁻¹)	Feed speed (mm/min)	Rotating speed (min ⁻¹)	Feed speed (mm/min)
6		5800	900	2650	140	4250	655	3600	555	3180	490
8		4400	900	2000	140	3180	655	2700	560	2390	495
10		3500	875	1600	140	2550	635	2150	530	1910	470
12		2900	875	1350	140	2120	635	1800	530	1590	470
16		2200	825	1000	125	1590	600	1350	500	1195	445
20		1750	810	800	110	1270	590	1050	495	955	440
Maximum cutting depth											

1. Please select high-precision machine and tool holder.
2. Please use air blow or cutting liquid with high mist retardant property.
3. Down milling is recommended in the case of side milling.
4. When the machine rigidity and workpiece fixture stability is low, vibration and abnormal noise may be generated. Please reduce the rotating speed and feed speed stated above correspondingly.
5. Make overhang of tool as short as possible in conditions of non-interference.

Cutting parameters for PML/PM series end mills

PML-2B★PM-2B★PML-2BL★PM-2BL/M/X★ PML-2BFP★PM-2BFP(general cutting)

Workpiece material	Cast iron, Carbon steel, Alloy steel ~30HRC		Stainless steel		Pre-hardened steel, quenched and tempered steel ~40HRC		Pre-hardened steel, quenched and tempered steel ~50HRC		Hardened steel ~55HRC	
	Diameter (mm)	Rotating speed (min ⁻¹)	Feed speed (mm/min)	Rotating speed (min ⁻¹)	Feed speed (mm/min)	Rotating speed (min ⁻¹)	Feed speed (mm/min)	Rotating speed (min ⁻¹)	Feed speed (mm/min)	Rotating speed (min ⁻¹)
R0.5	40000	960	22300	240	32000	385	25000	330	22280	295
R1.0	24000	1080	11150	275	16000	480	13000	330	11140	295
R1.5	15500	1150	7400	350	10600	545	8500	335	7430	295
R2.0	11500	1150	5550	445	8000	665	6500	450	5570	385
R2.5	9500	1270	4450	445	6400	665	5000	455	4455	405
R3.0	8000	1270	3700	470	5300	700	4200	470	3715	420
R4.0	6000	1575	2750	550	4000	850	3200	535	2785	465
R5.0	4800	1455	2200	520	3200	785	2500	535	2230	465
R6.0	4000	1330	1850	520	2650	740	2100	505	1855	450
R8.0	3000	1270	1350	455	2000	725	1600	455	1395	395
R10.0	2400	1150	1100	445	1600	675	1250	400	1115	360
Maximum cutting depth										

1. Please select high-precision machine and tool holder.
2. Please use air blow or cutting liquid with high mist retardant property.
3. Down milling is recommended in the case of side milling.
4. When the machine rigidity and workpiece fixture stability is low, vibration and abnormal noise may be generated. Please reduce the rotating speed and feed speed stated above correspondingly.
5. Make overhang of tool as short as possible in conditions of non-interference.

**PML-2B★PM-2B★PML-2BL★PM-2BL/M/X★
PML-2BFP★PM-2BFP(high speed cutting)**

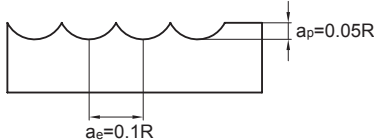
Workpiece material	Cast iron, Carbon steel, Alloy steel ~30HRC		Carbon steel, Alloy steel ~400HRC		Pre-hardened steel, quenched and tempered steel ~45HRC		Pre-hardened steel, quenched and tempered steel ~50HRC		Hardened steel ~55HRC	
	Diameter (mm)	Rotating speed (min ⁻¹)	Feed speed (mm/min)	Rotating speed (min ⁻¹)	Feed speed (mm/min)	Rotating speed (min ⁻¹)	Feed speed (mm/min)	Rotating speed (min ⁻¹)	Feed speed (mm/min)	Rotating speed (min ⁻¹)
R3.0	15000	4800	11500	2750	9500	2250	7960	1885	6370	1510
R4.0	11500	3650	8950	2100	7150	1700	5970	1420	4775	1135
R5.0	9500	3000	7150	1700	5700	1350	4775	1130	3820	905
R6.0	7950	2500	5950	1400	4750	1100	3980	920	3180	735
R8.0	5950	1900	4450	1050	3550	850	2985	760	2390	610
R10.0	4750	1500	3550	850	2850	680	2390	570	1910	455
Maximum cutting depth										

1. Please select high-precision machine and tool holder.
2. Please use air blow or cutting liquid with high mist retardant property.
3. When the machine rigidity and workpiece fixture stability is low, vibration and abnormal noise may be generated. Please reduce the rotating speed and feed speed stated above correspondingly.
4. Make overhang of tool as short as possible in conditions of non-interference.

PML-4B★PM-4B★PML-4BL★PM-4BL/M/X

Workpiece material	Cast iron, Carbon steel, Alloy steel ~30HRC		Stainless steel		Pre-hardened steel, quenched and tempered steel ~40HRC		Pre-hardened steel, quenched and tempered steel ~50HRC		Hardened steel ~55HRC	
	Diameter (mm)	Rotating speed (min ⁻¹)	Feed speed (mm/min)	Rotating speed (min ⁻¹)	Feed speed (mm/min)	Rotating speed (min ⁻¹)	Feed speed (mm/min)	Rotating speed (min ⁻¹)	Feed speed (mm/min)	Rotating speed (min ⁻¹)
R1.5	15500	2055	7400	625	10600	975	8500	600	7430	525
R2.0	11500	2055	5550	795	8000	1190	6500	800	5570	685
R2.5	9500	2270	4450	795	6400	1190	5000	810	4455	720
R3.0	8000	2270	3700	840	5300	1245	4200	840	3715	745
R4.0	6000	2810	2750	985	4000	1515	3200	950	2785	825
R5.0	4800	2595	2200	925	3200	1405	2500	950	2230	825
R6.0	4000	2375	1850	925	2650	1320	2100	905	1855	800
R8.0	3000	2270	1350	815	2000	1295	1600	810	1395	705
R10.0	2400	2055	1100	795	1600	1200	1250	715	1115	640

Maximum cutting depth

1. Please select high-precision machine and tool holder.
2. Please use air blow or cutting liquid with high mist retardant property.
3. When the machine rigidity and workpiece fixture stability is low, vibration and abnormal noise may be generated. Please reduce the rotating speed and feed speed stated above correspondingly.
4. Make overhang of tool as short as possible in conditions of non-interference.

Indexable milling tools

Solid carbide end mills

Cutting parameters for PML/PM series end mills

PM-2BC

Workpiece material			Pre-hardened steel, quenched and tempered steel ~40HRC			Pre-hardened steel, quenched and tempered steel ~50HRC			Hardened steel ~55HRC		
Diameter (mm)	Taper half angle (°)	Effective length (mm)	Rotating speed (min ⁻¹)	Feed speed (mm/min)	a _p (mm)	Rotating speed (min ⁻¹)	Feed speed (mm/min)	a _p (mm)	Rotating speed (min ⁻¹)	Feed speed (mm/min)	a _p (mm)
R0.25	0.5°	3	30000	300	0.03	30000	270	0.03	30000	240	0.03
		5	30000	250	0.02	30000	225	0.02	30000	200	0.02
	1.0°	3	30000	330	0.03	30000	300	0.03	30000	265	0.03
		5	30000	270	0.02	30000	245	0.02	30000	215	0.02
	1.5°	3	30000	350	0.03	30000	315	0.03	30000	280	0.03
		5	30000	300	0.02	30000	270	0.02	30000	240	0.02
R0.30	0.5°	5	30000	300	0.03	30000	270	0.03	30000	240	0.03
		8	30000	250	0.02	30000	225	0.02	30000	200	0.02
	1.0°	5	30000	350	0.03	30000	315	0.03	30000	280	0.03
		8	30000	300	0.02	30000	270	0.02	30000	240	0.02
		10	30000	270	0.02	30000	245	0.02	30000	215	0.02
		12	30000	250	0.015	30000	225	0.015	30000	200	0.015
	1.5°	15	30000	250	0.01	30000	225	0.01	30000	200	0.01
		8	30000	350	0.03	30000	315	0.03	30000	280	0.03
		15	30000	300	0.01	30000	270	0.01	30000	240	0.01
R0.40	0.5°	8	30000	350	0.05	30000	315	0.05	30000	280	0.05
		12	30000	300	0.04	30000	270	0.04	30000	240	0.04
	1.0°	8	30000	400	0.05	30000	360	0.05	30000	320	0.05
		12	30000	350	0.04	30000	315	0.04	30000	280	0.04
	1.5°	8	30000	450	0.05	30000	405	0.05	30000	360	0.05
		12	30000	400	0.04	30000	360	0.04	30000	320	0.04
R0.50	0.5°	10	22000	450	0.05	22000	405	0.05	22000	360	0.05
		15	22000	400	0.04	22000	360	0.04	22000	320	0.04
		20	22000	370	0.03	22000	335	0.03	22000	295	0.03
		25	22000	350	0.01	22000	315	0.01	22000	280	0.01
		30	22000	320	0.005	22000	290	0.005	22000	255	0.005
	1.0°	10	22000	500	0.05	22000	450	0.05	22000	400	0.05
		15	22000	450	0.04	22000	405	0.04	22000	360	0.04
		20	22000	430	0.02	22000	390	0.02	22000	345	0.02
		25	22000	400	0.015	22000	360	0.015	22000	320	0.015
		30	22000	360	0.01	22000	325	0.01	22000	290	0.01
		35	22000	320	0.005	22000	290	0.005	22000	255	0.005
Maximum cutting depth			<p> $\leq 0.1R (R < 0.5)$ $\leq 0.2R (R \geq 0.5)$ </p>								

Indexable milling tools

Solid carbide end mills

Cutting parameters for PML/PM series end mills

PM-2BC

Workpiece material			Pre-hardened steel, quenched and tempered steel ~40HRC			Pre-hardened steel, quenched and tempered steel ~50HRC			Hardened steel ~55HRC			
Diameter (mm)	Taper half angle (°)	Effective length (mm)	Rotating speed (min ⁻¹)	Feed speed (mm/min)	a _p (mm)	Rotating speed (min ⁻¹)	Feed speed (mm/min)	a _p (mm)	Rotating speed (min ⁻¹)	Feed speed (mm/min)	a _p (mm)	
R0.50	1.5°	10	22000	530	0.05	22000	475	0.05	22000	425	0.05	
		15	22000	500	0.04	22000	450	0.04	22000	400	0.04	
		20	22000	460	0.02	22000	415	0.02	22000	370	0.02	
	2°	15	22000	600	0.04	22000	540	0.04	22000	480	0.04	
		20	22000	500	0.02	22000	450	0.02	22000	400	0.02	
		3°	20	22000	550	0.03	22000	495	0.03	22000	440	0.03
		5°	20	22000	600	0.03	22000	540	0.03	22000	480	0.03
R0.60	0.5°	12	22000	500	0.05	22000	450	0.05	22000	400	0.05	
		24	22000	400	0.02	22000	360	0.02	22000	320	0.02	
	1.0°	12	22000	550	0.05	22000	495	0.05	22000	440	0.05	
		24	22000	450	0.02	22000	405	0.02	22000	360	0.02	
		12	22000	600	0.05	22000	540	0.05	22000	480	0.05	
	1.5°	24	22000	550	0.02	22000	495	0.02	22000	440	0.02	
		10	20000	600	0.1	20000	540	0.1	20000	480	0.1	
R0.75	0.5°	15	20000	550	0.08	20000	495	0.08	20000	440	0.08	
		30	20000	500	0.02	20000	450	0.02	20000	400	0.02	
		10	20000	650	0.1	20000	585	0.1	20000	520	0.1	
	1.0°	15	20000	600	0.08	20000	540	0.08	20000	480	0.08	
		20	20000	550	0.05	20000	495	0.05	20000	440	0.05	
		30	20000	530	0.02	20000	480	0.02	20000	425	0.02	
		10	20000	700	0.1	20000	630	0.1	20000	560	0.1	
1.5°	15	20000	650	0.08	20000	585	0.08	20000	520	0.08		
	30	20000	600	0.02	20000	540	0.02	20000	480	0.02		
	20	18000	800	0.05	18000	720	0.05	18000	640	0.05		
R1.0	0.5°	30	18000	650	0.03	18000	585	0.03	18000	520	0.03	
		40	18000	500	0.02	18000	450	0.02	18000	400	0.02	
		20	18000	900	0.05	18000	810	0.05	18000	720	0.05	
	1.0°	25	18000	850	0.04	18000	765	0.04	18000	680	0.04	
		30	18000	800	0.03	18000	720	0.03	18000	640	0.03	
		35	18000	750	0.03	18000	675	0.03	18000	600	0.03	
		40	18000	600	0.02	18000	540	0.02	18000	480	0.02	
50	18000	550	0.02	18000	495	0.02	18000	440	0.02			

Maximum cutting depth

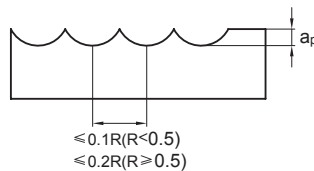

PM-2BC

Workpiece material			Pre-hardened steel, quenched and tempered steel ~40HRC			Pre-hardened steel, quenched and tempered steel ~50HRC			Hardened steel ~55HRC		
Diameter (mm)	Taper half angle (°)	Effective length (mm)	Rotating speed (min ⁻¹)	Feed speed (mm/min)	a _p (mm)	Rotating speed (min ⁻¹)	Feed speed (mm/min)	a _p (mm)	Rotating speed (min ⁻¹)	Feed speed (mm/min)	a _p (mm)
R1.0	1.5°	20	18000	1000	0.05	18000	900	0.05	18000	800	0.05
		30	18000	900	0.03	18000	810	0.03	18000	720	0.03
		40	18000	750	0.03	18000	675	0.03	18000	600	0.03
	2°	30	18000	900	0.04	18000	810	0.04	18000	720	0.04
		40	18000	850	0.03	18000	765	0.03	18000	680	0.03
		30	18000	1000	0.04	18000	900	0.04	18000	800	0.04
3°	40	18000	900	0.03	18000	810	0.03	18000	720	0.03	
		30	16000	1100	0.1	16000	990	0.1	16000	880	0.1
		40	16000	950	0.06	16000	855	0.06	16000	760	0.06
	1.0°	50	16000	800	0.03	16000	720	0.03	16000	640	0.03
		30	16000	1200	0.1	16000	1080	0.1	16000	960	0.1
		40	16000	1000	0.06	16000	900	0.06	16000	800	0.06
1.5°	50	16000	850	0.03	16000	765	0.03	16000	680	0.03	
	30	16000	1300	0.1	16000	1170	0.1	16000	1040	0.1	
	40	16000	1100	0.06	16000	990	0.06	16000	880	0.06	
R2.0	0.5°	50	16000	950	0.03	16000	855	0.03	16000	760	0.03
		60	14000	1100	0.1	14000	990	0.1	14000	880	0.1
		1.0°	60	14000	1100	0.1	14000	990	0.1	14000	880

Maximum cutting depth

$\leq 0.1R (R < 0.5)$
 $\leq 0.2R (R \geq 0.5)$

1. Please select high-precision machine and tool holder. When vibration and abnormal noise occur during machining, please reduce axial cutting depth a_p .
2. Please use air blow or cutting liquid with high mist retardant property.
3. Reduce feed speed correspondingly when rotating speed is low.
4. Because machining conditions such as machine and allowance for machining may vary, please adjust the parameters based on actual requirements.

Indexable milling tools

Solid carbide end mills

Cutting parameters for PML/PM series end mills

PML-2R★PM-2R

Workpiece material	Cast iron, Carbon steel, Alloy steel ~30HRC		Stainless steel		Pre-hardened steel, quenched and tempered steel ~40HRC		Pre-hardened steel, quenched and tempered steel ~50HRC		Hardened steel ~55HRC	
	Diameter (mm)	Rotating speed (min ⁻¹)	Feed speed (mm/min)	Rotating speed (min ⁻¹)	Feed speed (mm/min)	Rotating speed (min ⁻¹)	Feed speed (mm/min)	Rotating speed (min ⁻¹)	Feed speed (mm/min)	Rotating speed (min ⁻¹)
1	20000	240	20000	75	20000	195	20000	145	20000	95
2	15000	385	11150	100	15000	335	13000	215	11140	130
3	14000	655	7500	145	10600	505	8500	395	7430	245
4	10800	675	5500	155	8000	515	6500	405	5570	245
5	8200	695	4500	155	6400	540	5000	425	4460	260
6	7000	720	3700	170	5300	555	4200	435	3710	260
8	5200	720	2800	170	4000	555	3200	440	2785	275
10	4200	695	2200	170	3200	535	2500	420	2230	255
12	3500	695	1850	170	2650	535	2100	420	1855	255

Maximum cutting depth	ae=0.1D		ae=0.05D		ae=0.03D															
	Diagram	ap=1.5D	Diagram	ap=1.5D	Diagram	ap=1.5D														
		<table border="1"> <thead> <tr> <th>Diameter range</th> <th>Cutting depth ap</th> </tr> </thead> <tbody> <tr> <td>Ø1 ≤ D < Ø3</td> <td>0.15D</td> </tr> <tr> <td>Ø3 ≤ D < Ø6</td> <td>0.3D</td> </tr> <tr> <td>Ø6 ≤ D < Ø20</td> <td>0.5D</td> </tr> </tbody> </table>	Diameter range	Cutting depth ap	Ø1 ≤ D < Ø3	0.15D	Ø3 ≤ D < Ø6	0.3D	Ø6 ≤ D < Ø20	0.5D		<table border="1"> <thead> <tr> <th>Diameter range</th> <th>Cutting depth ap</th> </tr> </thead> <tbody> <tr> <td>Ø1 ≤ D < Ø3</td> <td>0.1D</td> </tr> <tr> <td>Ø3 ≤ D</td> <td>0.2D</td> </tr> </tbody> </table>	Diameter range	Cutting depth ap	Ø1 ≤ D < Ø3	0.1D	Ø3 ≤ D	0.2D		
Diameter range	Cutting depth ap																			
Ø1 ≤ D < Ø3	0.15D																			
Ø3 ≤ D < Ø6	0.3D																			
Ø6 ≤ D < Ø20	0.5D																			
Diameter range	Cutting depth ap																			
Ø1 ≤ D < Ø3	0.1D																			
Ø3 ≤ D	0.2D																			

- The above table shows the standard value of side milling. When milling slot, 50%~70% of rotating speed and 40%~60% of feed speed stated above are recommended as standard.
- Please select high-precision machine and tool holder.
- Please use air blow or cutting liquid with high mist retardant property.
- Down milling is recommended in the case of side milling.
- When the machine rigidity and workpiece fixture stability is low, vibration and abnormal noise may be generated. Please reduce the rotating speed and feed speed stated above correspondingly.
- Make overhang of tool as short as possible in conditions of non-interference.

PML-4R★PML-4R-H★PM-4R★PM-4R-H★PML-4RFP PM-4RFP★PM-4RBL/M/X★PM-4RBL/M/X-H

Workpiece material	Cast iron, Carbon steel, Alloy steel ~30HRC		Stainless steel		Pre-hardened steel, quenched and tempered steel ~40HRC		Pre-hardened steel, quenched and tempered steel ~50HRC		Hardened steel ~55HRC	
	Diameter (mm)	Rotating speed (min ⁻¹)	Feed speed (mm/min)	Rotating speed (min ⁻¹)	Feed speed (mm/min)	Rotating speed (min ⁻¹)	Feed speed (mm/min)	Rotating speed (min ⁻¹)	Feed speed (mm/min)	Rotating speed (min ⁻¹)
3	14000	985	7500	175	10600	755	8500	590	7430	435
4	10800	1010	5500	175	8000	770	6500	600	5570	445
5	8200	1055	4500	175	6400	805	5000	640	4460	470
6	7000	1080	3700	195	5300	830	4200	650	3710	470
8	5200	1070	2800	195	4000	815	3200	660	2785	485
10	4200	1055	2200	195	3200	805	2500	625	2230	450
12	3500	1055	1850	195	2650	805	2100	625	1855	450
16	2600	985	1400	175	2000	755	1600	590	1390	435

Maximum cutting depth	Diagram 1: $a_e=0.1D$		Diagram 2: $a_e=0.05D$		Diagram 3: $a_e=0.03D$																					
	a_p	Table	a_p	Table	a_p	Table																				
	$a_p=1.5D$	<table border="1"> <thead> <tr> <th>Diameter range</th> <th>Cutting depth a_p</th> </tr> </thead> <tbody> <tr> <td>$\varnothing 1 \leq D < \varnothing 3$</td> <td>0.15D</td> </tr> <tr> <td>$\varnothing 3 \leq D < \varnothing 6$</td> <td>0.3D</td> </tr> <tr> <td>$\varnothing 6 \leq D < \varnothing 20$</td> <td>0.5D</td> </tr> </tbody> </table>	Diameter range	Cutting depth a_p	$\varnothing 1 \leq D < \varnothing 3$	0.15D	$\varnothing 3 \leq D < \varnothing 6$	0.3D	$\varnothing 6 \leq D < \varnothing 20$	0.5D	$a_p=1.5D$	<table border="1"> <thead> <tr> <th>Diameter range</th> <th>Cutting depth a_p</th> </tr> </thead> <tbody> <tr> <td>$\varnothing 1 \leq D < \varnothing 3$</td> <td>0.1D</td> </tr> <tr> <td>$\varnothing 3 \leq D$</td> <td>0.2D</td> </tr> </tbody> </table>	Diameter range	Cutting depth a_p	$\varnothing 1 \leq D < \varnothing 3$	0.1D	$\varnothing 3 \leq D$	0.2D	$a_p=1.5D$	<table border="1"> <thead> <tr> <th>Diameter range</th> <th>Cutting depth a_p</th> </tr> </thead> <tbody> <tr> <td>$\varnothing 1 \leq D < \varnothing 3$</td> <td>0.1D</td> </tr> <tr> <td>$\varnothing 3 \leq D$</td> <td>0.2D</td> </tr> </tbody> </table>	Diameter range	Cutting depth a_p	$\varnothing 1 \leq D < \varnothing 3$	0.1D	$\varnothing 3 \leq D$	0.2D
Diameter range	Cutting depth a_p																									
$\varnothing 1 \leq D < \varnothing 3$	0.15D																									
$\varnothing 3 \leq D < \varnothing 6$	0.3D																									
$\varnothing 6 \leq D < \varnothing 20$	0.5D																									
Diameter range	Cutting depth a_p																									
$\varnothing 1 \leq D < \varnothing 3$	0.1D																									
$\varnothing 3 \leq D$	0.2D																									
Diameter range	Cutting depth a_p																									
$\varnothing 1 \leq D < \varnothing 3$	0.1D																									
$\varnothing 3 \leq D$	0.2D																									

- The above table shows the standard value of side milling. When milling slot, 50%~70% of rotating speed and 40%~60% of feed speed stated above are recommended as standard.
- Please select high-precision machine and tool holder.
- Please use air blow or cutting liquid with high mist retardant property.
- Down milling is recommended in the case of side milling.
- When the machine rigidity and workpiece fixture stability is low, vibration and abnormal noise may be generated. Please reduce the rotating speed and feed speed stated above correspondingly.
- Make overhang of tool as short as possible in conditions of non-interference.

Indexable milling tools

Solid carbide end mills

Cutting parameters for PML/PM series end mills

PM-4H★PM-4HL

Standard:

Workpiece material	Cast iron, Carbon steel, Alloy steel ~30HRC		Quenched and tempered steel ~40HRC		Quenched and tempered steel ~45HRC		Quenched and tempered steel ~50HRC		Quenched and tempered steel ~55HRC	
	Diameter × Corner radius	Rotating speed (min ⁻¹)	Feed speed (mm/min)	Rotating speed (min ⁻¹)	Feed speed (mm/min)	Rotating speed (min ⁻¹)	Feed speed (mm/min)	Rotating speed (min ⁻¹)	Feed speed (mm/min)	Rotating speed (min ⁻¹)
3.0×R0.8	10500	6250	8500	4500	7450	3900	5300	2600	3200	995
4.0×R1.0	7950	6600	6350	4800	5550	4200	4000	2750	2400	1050
5.0×R1.2	6350	7000	5100	5100	4450	4450	3200	2850	1900	1150
6.0×R1.0 6.0×R1.5	5300	7000	4250	5100	3700	4450	2650	2850	1600	1150
8.0×R1.0 8.0×R2.0	4550	7000	3200	5100	2800	4450	2000	2850	1200	1150
10.0×R1.0 10.0×R2.0	3200	7000	2550	5100	2250	4450	1600	2850	955	1150
12.0×R2.0 12.0×R3.0	2650	7000	2100	5100	1850	4450	1350	2850	795	1150
Maximum cutting depth	Maximum $a_p=0.5mm$						Maximum $a_p=0.4mm$		Maximum $a_p=0.2mm$	

1. Please select high-precision machine and tool holder.
2. Please use air blow or cutting liquid with high mist retardant property.
3. Down milling is recommended.
4. When the machine rigidity and workpiece fixture stability is low, vibration and abnormal noise may be generated. Please reduce the rotating speed and feed speed stated above correspondingly.
5. Make overhang of tool as short as possible in conditions of non-interference.
6. The above cutting parameters are based on contour machining when overhang $L/D \leq 4$. Please make adjustments according to the table below when overhang is different.

Different cutting parameters under different overhang of tool:

Overhang	Cutting speed(m/min)	Axial cutting depth (mm)	Feed speed (mm/min)
$L/D \leq 4$	100%	100%	100%
$L/D=5$	80%~90%	70%~90%	80%~90%
$L/D=6$	60%~80%	50%~70%	60%~80%

Cutting parameters for PML/PM series end mills

PM-4H★PM-4HL

High speed:

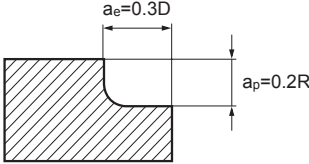
Workpiece material	Cast iron, Carbon steel, Alloy steel ~30HRC		Quenched and tempered steel ~40HRC		Quenched and tempered steel ~45HRC		Quenched and tempered steel ~50HRC		Quenched and tempered steel ~55HRC	
	Diameter × Corner radius	Rotating speed (min ⁻¹)	Feed speed (mm/min)	Rotating speed (min ⁻¹)	Feed speed (mm/min)	Rotating speed (min ⁻¹)	Feed speed (mm/min)	Rotating speed (min ⁻¹)	Feed speed (mm/min)	Rotating speed (min ⁻¹)
3.0×R0.8	21000	12500	21000	12000	16000	8400	16000	7850	10500	3300
4.0×R1.0	16000	13000	16000	12000	12000	9000	12000	8200	7950	3550
5.0×R1.2	12500	14000	12500	12500	9550	9550	9550	8600	6350	3800
6.0×R1.0 6.0×R1.5	10600	14000	10600	12700	7950	9550	7950	8600	5300	3800
8.0×R1.0 8.0×R2.0	7950	14000	7950	12700	5950	9550	5950	8600	4000	3800
10.0×R1.0 10.0×R2.0	6350	14000	6350	12700	4750	9550	4750	8600	3200	3800
12.0×R2.0 12.0×R3.0	5300	14000	5300	12700	4000	9550	4000	8600	2650	3800
Maximum cutting depth	Maximum $a_p=0.4mm$						Maximum $a_p=0.2mm$		Maximum $a_p=0.1mm$	
										

1. Please select high-precision machine and tool holder.
2. Please use air blow or cutting liquid with high mist retardant property.
3. Down milling is recommended.
4. When the machine rigidity and workpiece fixture stability is low, vibration and abnormal noise may be generated. Please reduce the rotating speed and feed speed stated above correspondingly.
5. Make overhang of tool as short as possible in conditions of non-interference.
6. The above cutting parameters are based on contour machining when overhang $L/D \leq 4$. Please make adjustments according to the table below when overhang is different.

Different cutting parameters under different overhang of tool:

Ratio of neck length to diameter	Cutting speed(m/min)	Axial cutting depth(mm)	Feed speed (mm/min)
$L/D \leq 4$	100%	100%	100%
$L/D=5$	60%~80%	60%~80%	60%~80%
$L/D=6$	40%~60%	40%~60%	40%~60%

GM-2E★GM-2EL★GM-2EBL/X

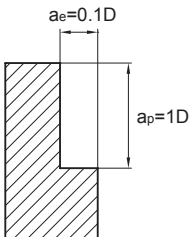
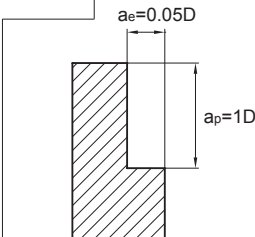
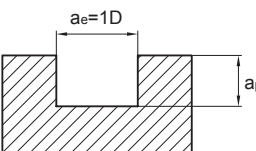
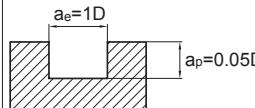
Workpiece material	Cast iron, Nodular cast iron		Carbon steel, Alloy steel ~750N/mm ²		Carbon steel, Alloy steel ~30HRC		Pre-hardened steel, quenched and tempered steel ~40HRC		Stainless steel		Pre-hardened steel, quenched and tempered steel ~50HRC								
	Diameter (mm)	Rotating speed (min ⁻¹)	Feed speed (mm/min)	Rotating speed (min ⁻¹)	Feed speed (mm/min)	Rotating speed (min ⁻¹)	Feed speed (mm/min)	Rotating speed (min ⁻¹)	Feed speed (mm/min)	Rotating speed (min ⁻¹)	Feed speed (mm/min)	Rotating speed (min ⁻¹)	Feed speed (mm/min)						
1	20000	165	20000	165	20000	135	20000	135	20000	50	20000	100							
2	15000	265	15000	265	15000	240	15000	235	11150	70	13000	150							
3	14000	455	14000	455	13000	420	10600	350	7500	100	8500	275							
4	10800	465	10800	465	10000	430	8000	355	5500	110	6500	280							
5	8200	485	8200	485	7600	450	6400	370	4500	110	5000	295							
6	7000	500	7000	500	6400	460	5300	385	3700	115	4200	300							
8	5200	495	5200	495	4800	455	4000	380	2800	115	3200	305							
10	4200	485	4200	485	3800	450	3200	370	2200	115	2500	290							
12	3500	485	3500	485	3200	450	2650	370	1850	115	2100	290							
14	3000	455	3000	455	2700	420	2300	350	1600	110	1800	275							
16	2600	455	2600	455	2400	420	2000	350	1400	100	1600	275							
18	2300	445	2300	445	2100	410	1800	345	1250	100	1400	270							
20	2050	445	2050	445	1900	410	1600	345	1100	100	1250	270							
Maximum cutting depth																			
							<table border="1"> <thead> <tr> <th>Diameter range</th> <th>Cutting depth a_p</th> </tr> </thead> <tbody> <tr> <td>$\varnothing 1 \leq D < \varnothing 3$</td> <td>0.15D</td> </tr> <tr> <td>$\varnothing 3 \leq D$</td> <td>0.3D</td> </tr> </tbody> </table>		Diameter range	Cutting depth a_p	$\varnothing 1 \leq D < \varnothing 3$	0.15D	$\varnothing 3 \leq D$	0.3D					
Diameter range	Cutting depth a_p																		
$\varnothing 1 \leq D < \varnothing 3$	0.15D																		
$\varnothing 3 \leq D$	0.3D																		

- The above table shows the standard value of side milling. When milling slot, 50%~70% of rotating speed and 40%~60% of feed speed stated above are recommended as standard.
- Please select high-precision machine and tool holder.
- Please use air blow or cutting liquid with high mist retardant property.
- Down milling is recommended in the case of side milling.
- When the machine rigidity and workpiece fixture stability is low, vibration and abnormal noise may be generated. Please reduce the rotating speed and feed speed stated above correspondingly.
- Make overhang of tool as short as possible in conditions of non-interference.

GM-2F★GM-2FL

Workpiece material	Cast iron, Nodular cast iron		Carbon steel, Alloy steel ~750N/mm ²		Carbon steel, Alloy steel ~30HRC		Pre-hardened steel, quenched and tempered steel ~40HRC		Stainless steel		Pre-hardened steel, quenched and tempered steel ~50HRC						
	Diameter (mm)	Rotating speed (min ⁻¹)	Feed speed (mm/min)	Rotating speed (min ⁻¹)	Feed speed (mm/min)	Rotating speed (min ⁻¹)	Feed speed (mm/min)	Rotating speed (min ⁻¹)	Feed speed (mm/min)	Rotating speed (min ⁻¹)	Feed speed (mm/min)	Rotating speed (min ⁻¹)	Feed speed (mm/min)				
1	20000	115	20000	115	20000	95	20000	95	20000	35	20000	70					
2	15000	185	15000	185	15000	170	15000	165	11150	50	13000	105					
3	14000	320	14000	320	13000	295	10600	245	7500	70	8500	190					
4	10800	325	10800	325	10000	300	8000	250	5500	80	6500	195					
5	8200	340	8200	340	7600	315	6400	260	4500	80	5000	205					
6	7000	350	7000	350	6400	320	5300	270	3700	80	4200	210					
8	5200	345	5200	345	4800	320	4000	265	2800	80	3200	210					
10	4200	340	4200	340	3800	315	3200	260	2200	80	2500	200					
12	3500	340	3500	340	3200	315	2650	260	1850	80	2100	200					
14	3000	320	3000	320	2700	295	2300	245	1600	80	1800	190					
16	2600	320	2600	320	2400	295	2000	245	1400	70	1600	190					
18	2300	310	2300	310	2100	290	1800	240	1250	70	1400	190					
20	2050	310	2050	310	1900	290	1600	240	1100	70	1250	190					
Maximum cutting depth																	
							<table border="1"> <thead> <tr> <th>Diameter range</th> <th>Cutting depth a_p</th> </tr> </thead> <tbody> <tr> <td>$\varnothing 1 \leq D < \varnothing 3$</td> <td>0.15D</td> </tr> <tr> <td>$\varnothing 3 \leq D$</td> <td>0.3D</td> </tr> </tbody> </table>						Diameter range	Cutting depth a_p	$\varnothing 1 \leq D < \varnothing 3$	0.15D	$\varnothing 3 \leq D$
Diameter range	Cutting depth a_p																
$\varnothing 1 \leq D < \varnothing 3$	0.15D																
$\varnothing 3 \leq D$	0.3D																

- The above table shows the standard value of side milling. When milling slot, 50%~70% of rotating speed and 40%~60% of feed speed stated above are recommended as standard.
- Please select high-precision machine and tool holder.
- Please use air blow or cutting liquid with high mist retardant property.
- Down milling is recommended in the case of side milling.
- When the machine rigidity and workpiece fixture stability is low, vibration and abnormal noise may be generated. Please reduce the rotating speed and feed speed stated above correspondingly.
- Make overhang of tool as short as possible in conditions of non-interference.

Indexable milling tools

Solid carbide end mills

Cutting parameters for GM series end mills

GM-2EX

Workpiece material	Cast iron, Nodular cast iron		Carbon steel, Alloy steel ~750N/mm ²		Carbon steel, Alloy steel ~30HRC		Pre-hardened steel, quenched and tempered steel ~40HRC		Stainless steel		Pre-hardened steel, quenched and tempered steel ~50HRC	
	Rotating speed (min ⁻¹)	Feed speed (mm/min)	Rotating speed (min ⁻¹)	Feed speed (mm/min)	Rotating speed (min ⁻¹)	Feed speed (mm/min)	Rotating speed (min ⁻¹)	Feed speed (mm/min)	Rotating speed (min ⁻¹)	Feed speed (mm/min)	Rotating speed (min ⁻¹)	Feed speed (mm/min)
6	5800	375	5800	375	5300	345	4250	275	2650	60	3600	230
8	4400	375	4400	375	4000	345	3180	275	2000	60	2700	235
10	3500	365	3500	365	3200	330	2550	265	1600	60	2150	220
12	2900	365	2900	365	2650	330	2120	265	1350	60	1800	220
16	2200	345	2200	345	2000	315	1590	250	1000	50	1350	210
20	1750	340	1750	340	1600	310	1270	245	800	45	1050	205
Maximum cutting depth	<p>The diagram illustrates the maximum cutting depth parameters for the end mill. It shows a cross-section of the tool cutting into a workpiece. The axial cutting depth is labeled as $a_e = 0.02D$, where D is the diameter of the end mill. The radial cutting depth is labeled as $a_p = 3D$.</p>											

1. Please select high-precision machine and tool holder.
2. Please use air blow or cutting liquid with high mist retardant property.
3. Down milling is recommended in the case of side milling.
4. When the machine rigidity and workpiece fixture stability is low, vibration and abnormal noise may be generated. Please reduce the rotating speed and feed speed stated above correspondingly.
5. Make overhang of tool as short as possible in conditions of non-interference.

GM-2EFP

Workpiece material	Cast iron, Nodular cast iron		Carbon steel, Alloy steel ~750N/mm ²		Carbon steel, Alloy steel ~30HRC		Pre-hardened steel, quenched and tempered steel ~40HRC		Stainless steel		Pre-hardened steel, quenched and tempered steel ~50HRC	
	Rotating speed (min ⁻¹)	Feed speed (mm/min)	Rotating speed (min ⁻¹)	Feed speed (mm/min)	Rotating speed (min ⁻¹)	Feed speed (mm/min)	Rotating speed (min ⁻¹)	Feed speed (mm/min)	Rotating speed (min ⁻¹)	Feed speed (mm/min)	Rotating speed (min ⁻¹)	Feed speed (mm/min)
6	7000	650	7000	650	6400	600	5300	500	3700	150	4200	390
8	5200	645	5200	645	4800	590	4000	495	2800	150	3200	395
10	4200	630	4200	630	3800	585	3200	480	2200	150	2500	380
12	3500	630	3500	630	3200	585	2650	480	1850	150	2100	380
16	2600	590	2600	590	2400	545	2000	455	1400	130	1600	355
20	2050	580	2050	580	1900	530	1600	450	1100	130	1250	350

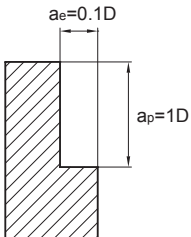
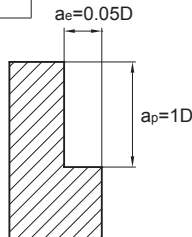
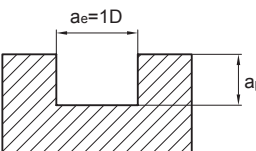
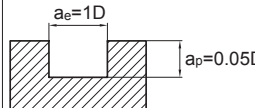
Maximum cutting depth																
	Diagram	Table	Diagram	Table												
		<table border="1"> <thead> <tr> <th>Diameter range</th> <th>Cutting depth a_p</th> </tr> </thead> <tbody> <tr> <td>$\varnothing 1 \leq D < \varnothing 3$</td> <td>0.15D</td> </tr> <tr> <td>$\varnothing 3 \leq D$</td> <td>0.3D</td> </tr> </tbody> </table>	Diameter range	Cutting depth a_p	$\varnothing 1 \leq D < \varnothing 3$	0.15D	$\varnothing 3 \leq D$	0.3D		<table border="1"> <thead> <tr> <th>Diameter range</th> <th>Cutting depth a_p</th> </tr> </thead> <tbody> <tr> <td>$\varnothing 1 \leq D < \varnothing 3$</td> <td>0.15D</td> </tr> <tr> <td>$\varnothing 3 \leq D$</td> <td>0.3D</td> </tr> </tbody> </table>	Diameter range	Cutting depth a_p	$\varnothing 1 \leq D < \varnothing 3$	0.15D	$\varnothing 3 \leq D$	0.3D
Diameter range	Cutting depth a_p															
$\varnothing 1 \leq D < \varnothing 3$	0.15D															
$\varnothing 3 \leq D$	0.3D															
Diameter range	Cutting depth a_p															
$\varnothing 1 \leq D < \varnothing 3$	0.15D															
$\varnothing 3 \leq D$	0.3D															

- The above table shows the standard value of side milling. When milling slot, 50%~70% of rotating speed and 40%~60% of feed speed stated above are recommended as standard.
- Please select high-precision machine and tool holder.
- Please use air blow or cutting liquid with high mist retardant property.
- Down milling is recommended in the case of side milling.
- When the machine rigidity and workpiece fixture stability is low, vibration and abnormal noise may be generated. Please reduce the rotating speed and feed speed stated above correspondingly.
- Make overhang of tool as short as possible in conditions of non-interference.

Indexable milling tools

Solid carbide end mills

Cutting parameters for GM series end mills

GM-3E★GM-3EL

Workpiece material	Cast iron, Nodular cast iron		Carbon steel, Alloy steel ~750N/mm ²		Carbon steel, Alloy steel ~30HRC		Pre-hardened steel, quenched and tempered steel ~40HRC		Stainless steel		Pre-hardened steel, quenched and tempered steel ~50HRC	
	Diameter (mm)	Rotating speed (min ⁻¹)	Feed speed (mm/min)	Rotating speed (min ⁻¹)	Feed speed (mm/min)	Rotating speed (min ⁻¹)	Feed speed (mm/min)	Rotating speed (min ⁻¹)	Feed speed (mm/min)	Rotating speed (min ⁻¹)	Feed speed (mm/min)	Rotating speed (min ⁻¹)
1	20000	215	20000	215	20000	175	20000	175	20000	65	20000	130
2	15000	345	15000	345	15000	310	15000	305	11150	90	13000	195
3	14000	590	14000	590	13000	546	10600	455	7500	130	8500	360
4	10800	600	10800	605	10000	560	8000	460	5500	145	6500	365
5	8200	630	8200	630	7600	585	6400	480	4500	145	5000	380
6	7000	650	7000	650	6400	600	5300	500	3700	150	4200	390
8	5200	645	5200	645	4800	590	4000	495	2800	150	3200	400
10	4200	630	4200	630	3800	585	3200	480	2200	150	2500	380
12	3500	630	3500	630	3200	585	2650	480	1850	150	2100	380
14	3000	590	3000	590	2700	545	2300	455	1600	145	1800	360
16	2600	590	2600	590	2400	545	2000	455	1400	130	1600	360
18	2300	580	2300	580	2100	530	1800	450	1250	130	1400	350
20	2050	580	2050	580	1900	530	1600	450	1100	130	1250	350

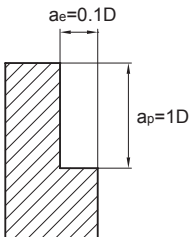
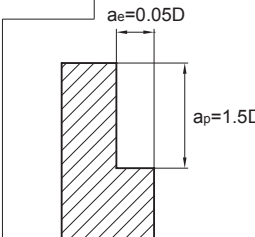
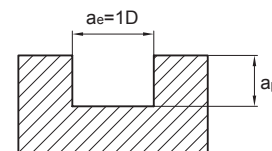
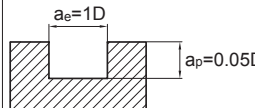
Maximum cutting depth										
	Diagram	Table	Diagram	Table						
		<table border="1"> <thead> <tr> <th>Diameter range</th> <th>Cutting depth a_p</th> </tr> </thead> <tbody> <tr> <td>$\varnothing 1 \leq D < \varnothing 3$</td> <td>0.15D</td> </tr> <tr> <td>$\varnothing 3 \leq D$</td> <td>0.3D</td> </tr> </tbody> </table>	Diameter range	Cutting depth a_p	$\varnothing 1 \leq D < \varnothing 3$	0.15D	$\varnothing 3 \leq D$	0.3D		
Diameter range	Cutting depth a_p									
$\varnothing 1 \leq D < \varnothing 3$	0.15D									
$\varnothing 3 \leq D$	0.3D									

- The above table shows the standard value of side milling. When milling slot, 50%~70% of rotating speed and 40%~60% of feed speed stated above are recommended as standard.
- Please select high-precision machine and tool holder.
- Please use air blow or cutting liquid with high mist retardant property.
- Down milling is recommended in the case of side milling.
- When the machine rigidity and workpiece fixture stability is low, vibration and abnormal noise may be generated. Please reduce the rotating speed and feed speed stated above correspondingly.
- Make overhang of tool as short as possible in conditions of non-interference.

GM-4E-G★GM-4EL-G★GM-4EBL/X-G

Workpiece material	Cast iron, Nodular cast iron		Carbon steel, Alloy steel ~750N/mm ²		Carbon steel, Alloy steel ~30HRC		Pre-hardened steel, quenched and tempered steel ~40HRC		Stainless steel		Pre-hardened steel, quenched and tempered steel ~50HRC	
	Diameter (mm)	Rotating speed (min ⁻¹)	Feed speed (mm/min)	Rotating speed (min ⁻¹)	Feed speed (mm/min)	Rotating speed (min ⁻¹)	Feed speed (mm/min)	Rotating speed (min ⁻¹)	Feed speed (mm/min)	Rotating speed (min ⁻¹)	Feed speed (mm/min)	Rotating speed (min ⁻¹)
1	20000	225	20000	225	20000	180	20000	180	20000	80	20000	135
2	15000	360	15000	360	15000	325	15000	315	11150	90	13000	200
3	14000	610	14000	610	13000	570	10600	470	7500	110	8500	370
4	10800	630	10800	630	10000	575	8000	480	5500	115	6500	380
5	8200	660	8200	660	7600	600	6400	505	4500	115	5000	400
6	7000	675	7000	675	6400	620	5300	515	3700	120	4200	405
8	5200	665	5200	665	4800	610	4000	510	2800	120	3200	415
10	4200	660	4200	660	3800	600	3200	505	2200	120	2500	390
12	3500	660	3500	660	3200	600	2650	505	1850	120	2100	390
14	3000	610	3000	610	2700	570	2300	470	1600	115	1800	370
16	2600	610	2600	610	2400	570	2000	470	1400	110	1600	370
18	2300	600	2300	600	2100	560	1800	460	1250	95	1400	365
20	2050	600	2050	600	1900	560	1600	460	1100	95	1250	365

Maximum cutting depth							
	<table border="1"> <thead> <tr> <th>Diameter range</th> <th>Cutting depth a_p</th> </tr> </thead> <tbody> <tr> <td>$\varnothing 1 \leq D < \varnothing 3$</td> <td>0.15D</td> </tr> <tr> <td>$\varnothing 3 \leq D$</td> <td>0.3D</td> </tr> </tbody> </table>	Diameter range	Cutting depth a_p	$\varnothing 1 \leq D < \varnothing 3$	0.15D	$\varnothing 3 \leq D$	0.3D
Diameter range	Cutting depth a_p						
$\varnothing 1 \leq D < \varnothing 3$	0.15D						
$\varnothing 3 \leq D$	0.3D						

1. The above table shows the standard value of side milling. When milling slot, 50%~70% of rotating speed and 40%~60% of feed speed stated above are recommended as standard.
2. Please select high-precision machine and tool holder.
3. Please use air blow or cutting liquid with high mist retardant property.
4. Down milling is recommended in the case of side milling.
5. When the machine rigidity and workpiece fixture stability is low, vibration and abnormal noise may be generated. Please reduce the rotating speed and feed speed stated above correspondingly.
6. Make overhang of tool as short as possible in conditions of non-interference

Indexable milling tools

Solid carbide end mills

Cutting parameters for GM series end mills

GM-4F-G★GM-4FL-G

Workpiece material	Cast iron, Nodular cast iron		Carbon steel, Alloy steel ~750N/mm ²		Carbon steel, Alloy steel ~30HRC		Pre-hardened steel, quenched and tempered steel ~40HRC		Stainless steel		Pre-hardened steel, quenched and tempered steel ~50HRC	
	Diameter (mm)	Rotating speed (min ⁻¹)	Feed speed (mm/min)	Rotating speed (min ⁻¹)	Feed speed (mm/min)	Rotating speed (min ⁻¹)	Feed speed (mm/min)	Rotating speed (min ⁻¹)	Feed speed (mm/min)	Rotating speed (min ⁻¹)	Feed speed (mm/min)	Rotating speed (min ⁻¹)
1	20000	160	20000	160	20000	125	20000	125	20000	55	20000	95
2	15000	250	15000	250	15000	230	15000	220	11150	65	13000	140
3	14000	430	14000	430	13000	400	10600	330	7500	80	8500	260
4	10800	440	10800	440	10000	400	8000	335	5500	80	6500	265
5	8200	460	8200	460	7600	420	6400	355	4500	80	5000	280
6	7000	470	7000	470	6400	435	5300	360	3700	85	4200	285
8	5200	465	5200	465	4800	430	4000	360	2800	85	3200	290
10	4200	460	4200	460	3800	420	3200	355	2200	85	2500	275
12	3500	460	3500	460	3200	420	2650	355	1850	80	2100	275
14	3000	430	3000	430	2700	400	2300	330	1600	80	1800	260
16	2600	430	2600	430	2400	400	2000	330	1400	80	1600	260
18	2300	420	2300	420	2100	390	1800	325	1250	70	1400	255
20	2050	420	2050	420	1900	390	1600	325	1100	70	1250	255

Maximum cutting depth							
	<table border="1"> <thead> <tr> <th>Diameter range</th> <th>Cutting depth a_p</th> </tr> </thead> <tbody> <tr> <td>$\varnothing 1 \leq D < \varnothing 3$</td> <td>0.15D</td> </tr> <tr> <td>$\varnothing 3 \leq D$</td> <td>0.3D</td> </tr> </tbody> </table>	Diameter range	Cutting depth a_p	$\varnothing 1 \leq D < \varnothing 3$	0.15D	$\varnothing 3 \leq D$	0.3D
Diameter range	Cutting depth a_p						
$\varnothing 1 \leq D < \varnothing 3$	0.15D						
$\varnothing 3 \leq D$	0.3D						

1. Please select high-precision machine and tool holder.
2. Please use air blow or cutting liquid with high mist retardant property.
3. Down milling is recommended in the case of side milling.
4. When the machine rigidity and workpiece fixture stability is low, vibration and abnormal noise may be generated. Please reduce the rotating speed and feed speed stated above correspondingly.
5. Make overhang of tool as short as possible in conditions of non-interference.

GM-4EX-G

Workpiece material	Cast iron, Nodular cast iron		Carbon steel, Alloy steel ~750N/mm ²		Carbon steel, Alloy steel ~30HRC		Pre-hardened steel, quenched and tempered steel ~40HRC		Stainless steel		Pre-hardened steel, quenched and tempered steel ~50HRC	
	Rotating speed (min ⁻¹)	Feed speed (mm/min)	Rotating speed (min ⁻¹)	Feed speed (mm/min)	Rotating speed (min ⁻¹)	Feed speed (mm/min)	Rotating speed (min ⁻¹)	Feed speed (mm/min)	Rotating speed (min ⁻¹)	Feed speed (mm/min)	Rotating speed (min ⁻¹)	Feed speed (mm/min)
6	5800	475	5800	475	5300	430	4250	340	2650	70	3600	290
8	4400	475	4400	475	4000	430	3180	340	2000	70	2700	290
10	3500	460	3500	460	3200	420	2550	330	1600	70	2150	280
12	2900	460	2900	460	2650	420	2120	330	1350	70	1800	280
16	2200	430	2200	430	2000	390	1590	315	1000	65	1350	260
20	1750	430	1750	430	1600	385	1270	310	800	60	1050	255
Maximum cutting depth	<p>The diagram illustrates the maximum cutting depth parameters for side milling. It shows a cross-section of a workpiece being milled by a tool. The maximum axial cutting depth is labeled as $a_e = 0.02D$, and the maximum radial cutting depth is labeled as $a_p = 3D$.</p>											

- 1.The above table shows the standard value of side milling. When milling slot, 50%~70% of rotating speed and 40%~60% of feed speed stated above are recommended as standard.
- 2.Please select high-precision machine and tool holder.
- 3.Please use air blow or cutting liquid with high mist retardant property.
- 4.Down milling is recommended in the case of side milling.
- 5.When the machine rigidity and workpiece fixture stability is low, vibration and abnormal noise may be generated. Please reduce the rotating speed and feed speed stated above correspondingly.
- 6.Make overhang of tool as short as possible in conditions of non-interference

GM-4E★GM-4EL★GM-4EBL/X

Workpiece material	Cast iron, Nodular cast iron		Carbon steel, Alloy steel ~750N/mm ²		Carbon steel, Alloy steel ~30HRC		Pre-hardened steel, quenched and tempered steel ~40HRC		Stainless steel		Pre-hardened steel, quenched and tempered steel ~50HRC	
	Diameter (mm)	Rotating speed (min ⁻¹)	Feed speed (mm/min)	Rotating speed (min ⁻¹)	Feed speed (mm/min)	Rotating speed (min ⁻¹)	Feed speed (mm/min)	Rotating speed (min ⁻¹)	Feed speed (mm/min)	Rotating speed (min ⁻¹)	Feed speed (mm/min)	Rotating speed (min ⁻¹)
1	20000	250	20000	250	20000	200	20000	200	20000	90	20000	150
2	15000	400	15000	400	15000	360	15000	350	11150	100	13000	225
3	14000	680	14000	680	13000	630	10600	525	7500	120	8500	410
4	10800	700	10800	700	10000	640	8000	535	5500	125	6500	420
5	8200	730	8200	730	7600	670	6400	560	4500	125	5000	440
6	7000	750	7000	750	6400	690	5300	575	3700	135	4200	450
8	5200	740	5200	740	4800	680	4000	565	2800	135	3200	460
10	4200	730	4200	730	3800	670	3200	560	2200	135	2500	435
12	3500	730	3500	730	3200	670	2650	560	1850	135	2100	435
14	3000	680	3000	680	2700	630	2300	525	1600	125	1800	410
16	2600	680	2600	680	2400	630	2000	525	1400	120	1600	410
18	2300	670	2300	670	2100	620	1800	515	1250	105	1400	405
20	2050	670	2050	670	1900	620	1600	515	1100	105	1250	405

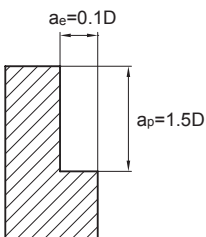
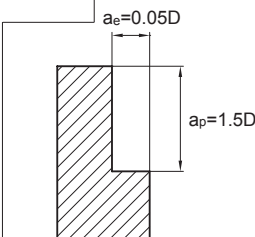
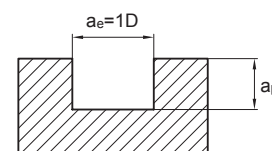
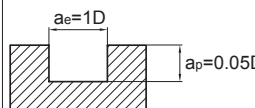
Maximum cutting depth										
	Diagram	Table	Diagram	Table						
		<table border="1"> <thead> <tr> <th>Diameter range</th> <th>Cutting depth a_p</th> </tr> </thead> <tbody> <tr> <td>$\varnothing 1 \leq D < \varnothing 3$</td> <td>0.15D</td> </tr> <tr> <td>$\varnothing 3 \leq D$</td> <td>0.3D</td> </tr> </tbody> </table>	Diameter range	Cutting depth a_p	$\varnothing 1 \leq D < \varnothing 3$	0.15D	$\varnothing 3 \leq D$	0.3D		
Diameter range	Cutting depth a_p									
$\varnothing 1 \leq D < \varnothing 3$	0.15D									
$\varnothing 3 \leq D$	0.3D									

- The above table shows the standard value of side milling. When milling slot, 50%~70% of rotating speed and 40%~60% of feed speed stated above are recommended as standard.
- Please select high-precision machine and tool holder.
- Please use air blow or cutting liquid with high mist retardant property.
- Down milling is recommended in the case of side milling.
- When the machine rigidity and workpiece fixture stability is low, vibration and abnormal noise may be generated. Please reduce the rotating speed and feed speed stated above correspondingly.
- Make overhang of tool as short as possible in conditions of non-interference.

GM-4EFP

Workpiece material	Cast iron, Nodular cast iron		Carbon steel, Alloy steel ~750N/mm ²		Carbon steel, Alloy steel ~30HRC		Pre-hardened steel, quenched and tempered steel ~40HRC		Stainless steel		Pre-hardened steel, quenched and tempered steel ~50HRC	
	Rotating speed (min ⁻¹)	Feed speed (mm/min)	Rotating speed (min ⁻¹)	Feed speed (mm/min)	Rotating speed (min ⁻¹)	Feed speed (mm/min)	Rotating speed (min ⁻¹)	Feed speed (mm/min)	Rotating speed (min ⁻¹)	Feed speed (mm/min)	Rotating speed (min ⁻¹)	Feed speed (mm/min)
6	7000	975	7000	975	6400	900	5300	750	3700	175	4200	585
8	5200	960	5200	960	4800	995	4000	735	2800	175	3200	600
10	4200	950	4200	950	3800	970	3200	730	2200	175	2500	565
12	3500	950	3500	950	3200	970	2650	730	1850	175	2100	565
16	2600	885	2600	885	2400	820	2000	680	1400	155	1600	535
20	2050	870	2050	870	1900	805	1600	670	1100	135	1250	525

Maximum cutting depth												
	ae	ap	ae	ap								
	1D	ap	<table border="1"> <thead> <tr> <th>Diameter range</th> <th>Cutting depth ap</th> </tr> </thead> <tbody> <tr> <td>$\varnothing 1 \leq D < \varnothing 3$</td> <td>0.15D</td> </tr> <tr> <td>$\varnothing 3 \leq D$</td> <td>0.3D</td> </tr> </tbody> </table>		Diameter range	Cutting depth ap	$\varnothing 1 \leq D < \varnothing 3$	0.15D	$\varnothing 3 \leq D$	0.3D	1D	ap=0.05D
			Diameter range	Cutting depth ap								
$\varnothing 1 \leq D < \varnothing 3$	0.15D											
$\varnothing 3 \leq D$	0.3D											

- The above table shows the standard value of side milling. When milling slot, 50%~70% of rotating speed and 40%~60% of feed speed stated above are recommended as standard.
- Please select high-precision machine and tool holder.
- Please use air blow or cutting liquid with high mist retardant property.
- Down milling is recommended in the case of side milling.
- When the machine rigidity and workpiece fixture stability is low, vibration and abnormal noise may be generated. Please reduce the rotating speed and feed speed stated above correspondingly.
- Make overhang of tool as short as possible in conditions of non-interference.

Indexable milling tools

Solid carbide end mills

Cutting parameters for GM series end mills

GM-6E

Workpiece material	Cast iron, Nodular cast iron		Carbon steel, Alloy steel ~750N/mm ²		Carbon steel, Alloy steel ~30HRC		Pre-hardened steel, quenched and tempered steel ~40HRC		Stainless steel		Pre-hardened steel, quenched and tempered steel ~50HRC	
	Diameter (mm)	Rotating speed (min ⁻¹)	Feed speed (mm/min)	Rotating speed (min ⁻¹)	Feed speed (mm/min)	Rotating speed (min ⁻¹)	Feed speed (mm/min)	Rotating speed (min ⁻¹)	Feed speed (mm/min)	Rotating speed (min ⁻¹)	Feed speed (mm/min)	Rotating speed (min ⁻¹)
6	7000	890	7000	890	6400	820	5300	680	3700	160	4200	540
8	5200	890	5200	890	4800	820	4000	680	2800	160	3200	550
10	4200	860	4200	860	3800	800	3200	665	2200	160	2500	520
12	3500	860	3500	860	3200	800	2650	665	1850	160	2100	520
14	3000	810	3000	810	2700	750	2300	625	1600	150	1800	490
16	2600	810	2600	810	2400	750	2000	625	1400	150	1600	490
18	2300	800	2300	800	2100	740	1800	615	1250	125	1400	485
20	2050	800	2050	800	1900	740	1600	615	1100	125	1250	485

Maximum cutting depth

The diagram illustrates the maximum cutting depth parameters for the end mill. It shows a cross-section of the tool cutting into a workpiece. The axial cutting depth is labeled as $a_e = 0.05D$, where D is the diameter of the end mill. The radial cutting depth is labeled as $a_p = 1.5D$.

1. Please select high-precision machine and tool holder.
2. Please use air blow or cutting liquid with high mist retardant property.
3. Down milling is recommended in the case of side milling.
4. When the machine rigidity and workpiece fixture stability is low, vibration and abnormal noise may be generated. Please reduce the rotating speed and feed speed stated above correspondingly.
5. Make overhang of tool as short as possible in conditions of non-interference.



Indexable milling tools

Solid carbide end mills

Cutting parameters for GM series end mills

GM-6EL

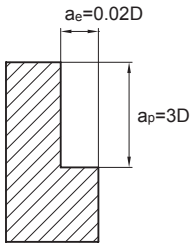
Workpiece material	Cast iron, Nodular cast iron		Carbon steel, Alloy steel ~750N/mm ²		Carbon steel, Alloy steel ~30HRC		Pre-hardened steel, quenched and tempered steel ~40HRC		Stainless steel		Pre-hardened steel, quenched and tempered steel ~50HRC	
	Rotating speed (min ⁻¹)	Feed speed (mm/min)	Rotating speed (min ⁻¹)	Feed speed (mm/min)	Rotating speed (min ⁻¹)	Feed speed (mm/min)	Rotating speed (min ⁻¹)	Feed speed (mm/min)	Rotating speed (min ⁻¹)	Feed speed (mm/min)	Rotating speed (min ⁻¹)	Feed speed (mm/min)
6	5800	750	5800	750	5300	685	4250	545	2650	115	3600	460
8	4400	750	4400	750	4000	685	3180	545	2000	115	2700	465
10	3500	730	3500	730	3200	665	2550	530	1600	115	2150	440
12	2900	730	2900	730	2650	665	2120	530	1350	115	1800	440
14	2500	685	2500	685	2300	625	1820	500	1150	105	1550	415
16	2200	685	2200	685	2000	625	1590	500	1000	105	1350	415
18	1950	675	1950	675	1800	615	1420	490	900	90	1200	410
20	1750	675	1750	675	1600	615	1270	490	800	90	1050	410
Maximum cutting depth	 <p>The diagram illustrates the maximum cutting depth parameters for the end mill. It shows a cross-section of a workpiece being milled. The axial cutting depth is labeled as $a_e = 0.02D$, where D is the diameter of the end mill. The radial cutting depth is labeled as $a_p = 3D$.</p>											

1. Please select high-precision machine and tool holder.
2. Please use air blow or cutting liquid with high mist retardant property.
3. Down milling is recommended in the case of side milling.
4. When the machine rigidity and workpiece fixture stability is low, vibration and abnormal noise may be generated. Please reduce the rotating speed and feed speed stated above correspondingly.
5. Make overhang of tool as short as possible in conditions of non-interference.

GM-2EP

Workpiece material		Cast iron, Carbon steel, Alloy steel ~750N/mm ²			Carbon steel, Alloy steel ~30HRC			Pre-hardened steel, quenched and tempered steel ~40HRC			Stainless steel		
Diameter (mm)	Effective length (mm)	Rotating speed (min ⁻¹)	Feed speed (mm/min)	a _p (mm)	Rotating speed (min ⁻¹)	Feed speed (mm/min)	a _p (mm)	Rotating speed (min ⁻¹)	Feed speed (mm/min)	a _p (mm)	Rotating speed (min ⁻¹)	Feed speed (mm/min)	a _p (mm)
0.5	4	28000	500	0.023	28000	400	0.021	28000	250	0.018	25000	200	0.014
	6	22000	400	0.007	22000	350	0.06	22000	150	0.005	20000	150	0.004
	8	18000	300	0.005	18000	300	0.005	18000	150	0.004	20000	150	0.003
0.8	4	32000	900	0.057	32000	600	0.053	32000	600	0.044	25000	400	0.035
	6	26000	700	0.036	26000	450	0.034	26000	400	0.028	21000	300	0.022
	8	22000	500	0.026	22000	350	0.024	22000	300	0.02	18000	200	0.016
	10	22000	500	0.01	22000	350	0.01	22000	300	0.008	18000	200	0.006
1.0	4	2900	1300	0.08	27000	1000	0.08	26000	900	0.07	20000	600	0.05
	6	29000	1300	0.07	27000	1000	0.07	26000	900	0.06	20000	600	0.04
	8	24000	900	0.05	23000	800	0.04	22000	700	0.04	18000	400	0.03
	10	20000	700	0.03	19000	600	0.03	18000	500	0.03	15000	300	0.02
	12	20000	700	0.02	19000	600	0.02	18000	500	0.02	15000	300	0.01
	14	18000	500	0.015	15000	400	0.01	15000	360	0.01	12000	200	0.008
1.2	6	25000	1100	0.09	23000	1000	0.08	22000	900	0.07	17000	600	0.05
	8	21000	900	0.07	20000	700	0.07	19000	700	0.05	14000	400	0.04
	10	21000	900	0.06	20000	700	0.05	19000	700	0.04	14000	400	0.03
	12	18000	700	0.04	17000	600	0.04	16000	500	0.03	11000	300	0.02
1.5	6	20000	1200	0.15	18000	1000	0.14	18000	900	0.11	14000	600	0.09
	8	19000	900	0.11	16000	800	0.1	15000	700	0.08	12000	400	0.07
	10	19000	900	0.09	16000	800	0.08	15000	700	0.06	12000	400	0.05
	12	19000	900	0.07	16000	800	0.06	15000	700	0.05	12000	400	0.04
	14	19000	700	0.06	16000	650	0.05	15000	630	0.04	12000	360	0.03
2.0	6	16000	1300	0.34	15000	1100	0.31	14000	1000	0.26	11000	700	0.21
	8	16000	1300	0.29	15000	1100	0.26	14000	1000	0.22	11000	700	0.18
	10	14000	900	0.26	13000	800	0.24	12000	700	0.20	9000	500	0.16
	12	14000	900	0.14	13000	800	0.13	12000	700	0.11	9000	500	0.09
	14	14000	900	0.10	13000	800	0.11	12000	700	0.09	9000	500	0.07
	16	14000	900	0.08	13000	800	0.08	12000	700	0.07	9000	500	0.06

Maximum cutting depth

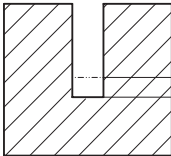

Ap (Once cutting depth)

GM-2EP

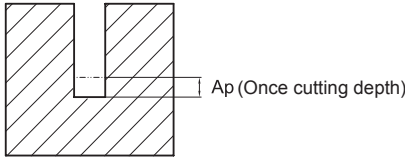
Workpiece material		Cast iron, Carbon steel, Alloy steel ~750N/mm ²			Carbon steel, Alloy steel ~30HRC			Pre-hardened steel, quenched and tempered steel ~40HRC			Stainless steel		
Diameter (mm)	Effective length (mm)	Rotating speed (min ⁻¹)	Feed speed (mm/min)	a _p (mm)	Rotating speed (min ⁻¹)	Feed speed (mm/min)	a _p (mm)	Rotating speed (min ⁻¹)	Feed speed (mm/min)	a _p (mm)	Rotating speed (min ⁻¹)	Feed speed (mm/min)	a _p (mm)
2.5	8	13000	1300	0.42	12000	1100	0.39	11000	1000	0.33	9000	700	0.26
	10	13000	1300	0.36	12000	1100	0.33	11000	1000	0.28	9000	700	0.22
	12	13000	1300	0.24	12000	1100	0.23	11000	1000	0.19	9000	700	0.15
	14	12000	900	0.18	10000	800	0.17	9000	700	0.14	7000	500	0.11
	16	12000	900	0.13	10000	800	0.12	9000	700	0.09	7000	500	0.08
	18	12000	800	0.11	10000	720	0.10	9000	630	0.07	7000	450	0.07
	20	12000	800	0.09	10000	720	0.08	9000	630	0.05	7000	450	0.05
3.0	6	11000	1300	0.42	10000	1100	0.39	10000	1000	0.32	8000	700	0.27
	8	11000	1300	0.39	10000	1100	0.36	10000	1000	0.30	8000	700	0.24
	10	11000	1300	0.31	10000	1100	0.29	10000	1000	0.24	8000	700	0.19
	12	11000	1100	0.29	10000	1000	0.27	10000	900	0.22	8000	650	0.16
	14	11000	1100	0.27	10000	1000	0.25	10000	900	0.20	8000	650	0.15
	16	10000	850	0.22	10000	750	0.20	9000	650	0.17	6000	450	0.13
	18	10000	850	0.16	10000	750	0.14	9000	650	0.12	6000	450	0.10
4.0	20	10000	850	0.12	10000	750	0.10	9000	650	0.08	6000	450	0.07
	12	8000	1300	0.42	7000	1100	0.38	7000	1000	0.32	6000	700	0.26
	16	8000	1100	0.39	7000	1000	0.35	7000	900	0.30	6000	650	0.24
	20	7000	900	0.34	7000	800	0.30	6000	700	0.27	5000	500	0.20
5.0	25	7000	900	0.30	7000	800	0.27	6000	700	0.24	5000	500	0.15
	16	6000	1200	0.49	6000	1000	0.45	5000	1000	0.38	5000	600	0.30
	25	5000	800	0.45	5000	720	0.42	5000	700	0.35	5000	600	0.25
Maximum cutting depth													

Indexable
milling toolsSolid carbide
end mills

Cutting parameters for GM series end mills

1. Please select high-precision machine and tool holder.
2. Please use air blow or cutting liquid with high mist retardant property.
3. Make overhang of tool as short as possible in conditions of non-interference.
4. Reduce feed speed correspondingly when rotating speed is low.

GM-2ES

Workpiece material	Cast iron, Nodular cast iron		Carbon steel, Alloy steel ~750N/mm ²		Carbon steel, Alloy steel ~30HRC		Pre-hardened steel, quenched and tempered steel ~40HRC		Stainless steel	
	Diameter (mm)	Rotating speed (min ⁻¹)	Feed speed (mm/min)	Rotating speed (min ⁻¹)	Feed speed (mm/min)	Rotating speed (min ⁻¹)	Feed speed (mm/min)	Rotating speed (min ⁻¹)	Feed speed (mm/min)	Rotating speed (min ⁻¹)
0.3	32000	115	32000	115	32000	115	32000	80	32000	40
0.4	32000	125	32000	125	32000	125	32000	90	27500	50
0.5	32000	125	32000	125	29500	125	25000	90	22000	50
0.6	32000	125	32000	125	24500	125	21000	90	18500	50
0.7	32000	125	32000	125	24500	125	21000	90	18500	50
0.8	24500	125	24500	125	18500	125	15500	90	13500	50
0.9	24500	125	24500	125	18500	125	15500	90	13500	50
1.0	21000	140	25000	165	16800	130	14500	90	10000	50
1.5	13000	140	15000	165	11800	130	10000	90	7000	50
2.0	13000	160	15000	185	11800	145	10000	100	7000	60
2.5	8700	200	10000	240	8200	185	6600	100	4700	60
3.0	8700	235	10000	270	8200	220	6600	100	4700	75

Maximum cutting depth		
	Diameter range	Cutting depth a _p
	D < Ø1	0.05D
Ø1 ≤ D ≤ Ø3	0.15D	

1. Please select high-precision machine and tool holder.
2. Please use air blow or cutting liquid with high mist retardant property.
3. When the machine rigidity and workpiece fixture stability is low, vibration and abnormal noise may be generated. Please reduce the rotating speed and feed speed stated above correspondingly.
4. Make overhang of tool as short as possible in conditions of non-interference.

GM-2B★GM-2BL/M/X★GM-2BFP

Workpiece material	Cast iron, Nodular cast iron		Carbon steel, Alloy steel ~750N/mm ²		Carbon steel, Alloy steel ~30HRC		Pre-hardened steel, quenched and tempered steel ~40HRC		Stainless steel		Pre-hardened steel, quenched and tempered steel ~50HRC	
	Diameter (mm)	Rotating speed (min ⁻¹)	Feed speed (mm/min)	Rotating speed (min ⁻¹)	Feed speed (mm/min)	Rotating speed (min ⁻¹)	Feed speed (mm/min)	Rotating speed (min ⁻¹)	Feed speed (mm/min)	Rotating speed (min ⁻¹)	Feed speed (mm/min)	Rotating speed (min ⁻¹)
R0.5	40000	800	40000	800	38000	700	32000	320	22300	200	25000	275
R1.0	24000	900	24000	900	19000	760	16000	400	11150	230	13000	275
R1.5	15500	950	15500	950	12750	760	10600	450	7400	290	8500	280
R2.0	11500	950	11500	950	9550	760	8000	550	5550	370	6500	370
R2.5	9500	1050	9500	1050	7650	800	6400	550	4450	370	5000	375
R3.0	8000	1050	8000	1050	6400	800	5300	580	3700	390	4200	390
R4.0	6000	1300	6000	1300	4800	950	4000	700	2750	455	3200	440
R5.0	4800	1200	4800	1200	3800	900	3200	650	2200	430	2500	440
R6.0	4000	1100	4000	1100	3200	840	2650	610	1850	430	2100	420
R8.0	3000	1050	3000	1050	2400	800	2000	600	1350	380	1600	375
R10.0	2400	950	2400	950	1900	680	1600	560	1100	370	1250	330
Maximum cutting depth												

1. Please select high-precision machine and tool holder.
2. Please use air blow or cutting liquid with high mist retardant property.
3. When the machine rigidity and workpiece fixture stability is low, vibration at speed and feed speed stated above correspondingly.
4. Make overhang of tool as short as possible in conditions of non-interferenc



Indexable milling tools

Solid carbide end mills

Cutting parameters for GM series end mills



MILLING

Solid Carbide End Mills

Cutting parameters for GM series end mills

GM-4B★GM-4BL/M/X

Workpiece material	Cast iron, Nodular cast iron		Carbon steel, Alloy steel ~750N/mm ²		Carbon steel, Alloy steel ~30HRC		Pre-hardened steel, quenched and tempered steel ~40HRC		Stainless steel		Pre-hardened steel, quenched and tempered steel ~50HRC	
Cutting speed	150 m/min		150m/min		120m/min		100m/min		70m/min		80m/min	
Diameter (mm)	Rotating speed (min ⁻¹)	Feed speed (mm/min)	Rotating speed (min ⁻¹)	Feed speed (mm/min)	Rotating speed (min ⁻¹)	Feed speed (mm/min)	Rotating speed (min ⁻¹)	Feed speed (mm/min)	Rotating speed (min ⁻¹)	Feed speed (mm/min)	Rotating speed (min ⁻¹)	Feed speed (mm/min)
R1.5	15500	1710	15500	1710	12750	1340	10600	810	7400	520	8500	500
R2.0	11500	1710	11500	1710	9550	1340	8000	990	5550	660	6500	665
R2.5	9500	1890	9500	1890	7650	1440	6400	990	4450	660	5000	675
R3.0	8000	1890	8000	1890	6400	1440	5300	1040	3700	700	4200	700
R4.0	6000	2340	6000	2340	4800	1710	4000	1260	2750	820	3200	790
R5.0	4800	2160	4800	2160	3800	1620	3200	1170	2200	770	2500	790
R6.0	4000	1980	4000	1980	3200	1510	2650	1100	1850	770	2100	755
R8.0	3000	1890	3000	1890	2400	1440	2000	1080	1350	680	1600	675
R10.0	2400	1710	2400	1710	1900	1220	1600	1000	1100	660	1250	595
Maximum cutting depth												

1. Please select high-precision machine and tool holder.
2. Please use air blow or cutting liquid with high mist retardant property.
3. When the machine rigidity and workpiece fixture stability is low, vibration and abnormal noise may be generated. Please reduce the rotating speed and feed speed stated above correspondingly.
4. Make overhang of tool as short as possible in conditions of non-interference.

Indexable milling tools

Solid carbide end mills

Cutting parameters for GM series end mills

GM-2BS

Workpiece material	Cast iron, Nodular cast iron		Carbon steel, Alloy steel ~750N/mm ²		Carbon steel, Alloy steel ~30HRC		Pre-hardened steel, quenched and tempered steel ~40HRC		Stainless steel	
	Rotating speed (min ⁻¹)	Feed speed (mm/min)	Rotating speed (min ⁻¹)	Feed speed (mm/min)	Rotating speed (min ⁻¹)	Feed speed (mm/min)	Rotating speed (min ⁻¹)	Feed speed (mm/min)	Rotating speed (min ⁻¹)	Feed speed (mm/min)
R0.15	32000	300	32000	300	32000	270	32000	250	32000	150
R0.2	32000	380	32000	380	32000	320	32000	300	32000	175
R0.25	32000	460	32000	460	32000	410	32000	330	32000	205
R0.3	32000	535	32000	535	32000	500	32000	420	32000	265
R0.35	32000	550	32000	550	32000	520	32000	440	32000	270
R0.4	32000	610	32000	610	32000	560	32000	460	27500	285
R0.45	32000	700	32000	700	32000	600	25000	400	27500	285
R0.5	32000	765	32000	765	32000	640	25000	400	22000	285
R1.0	24000	900	24000	900	19000	760	16000	400	11150	230
R1.5	15500	950	15500	950	12750	760	10600	450	7400	290

Maximum cutting depth			
	Diameter range	Cutting depth a _p	Cutting width a _e
	D < Ø1	0.05R	0.2R
Ø1 ≤ D ≤ Ø3	0.1R	0.2R	

1. Please select high-precision machine and tool holder.
2. Please use air blow or cutting liquid with high mist retardant property.
3. Make overhang of tool as short as possible in conditions of non-interference.
4. Reduce feed speed correspondingly when rotating speed is low.

Indexable milling tools

Solid carbide end mills

Cutting parameters for GM series end mills

GM-2BP

Workpiece material		Cast iron, Carbon steel, Alloy steel ~750N/mm ²				Carbon steel, Alloy steel ~30HRC				Pre-hardened steel, quenched and tempered steel ~40HRC				Stainless steel			
Diameter (mm)	Effective length (mm)	Rotating speed (min ⁻¹)	Feed speed (mm/min)	a _p (mm)	a _e (mm)	Rotating speed (min ⁻¹)	Feed speed (mm/min)	a _p (mm)	a _e (mm)	Rotating speed (min ⁻¹)	Feed speed (mm/min)	a _p (mm)	a _e (mm)	Rotating speed (min ⁻¹)	Feed speed (mm/min)	a _p (mm)	a _e (mm)
R0.25	4	27000	400	0.02	0.025	27000	380	0.02	0.025	27000	300	0.02	0.025	27000	200	0.02	0.025
	6	21000	200	0.01	0.015	21000	180	0.01	0.015	21000	160	0.01	0.015	21000	150	0.01	0.015
R0.3	4	27000	400	0.03	0.12	27000	380	0.03	0.12	25000	250	0.03	0.12	24000	200	0.03	0.12
	6	25000	300	0.03	0.12	25000	280	0.03	0.12	20000	150	0.03	0.12	20000	140	0.03	0.12
R0.4	8	25000	240	0.03	0.12	25000	225	0.03	0.12	20000	120	0.03	0.12	20000	110	0.03	0.12
	4	27000	600	0.04	0.16	27000	550	0.04	0.16	23000	450	0.04	0.16	21000	300	0.04	0.16
R0.4	6	24000	400	0.04	0.12	24000	360	0.04	0.12	21000	250	0.04	0.12	19000	200	0.04	0.12
	8	22000	300	0.04	0.12	22000	270	0.04	0.12	19000	150	0.04	0.12	19000	140	0.04	0.12
R0.4	10	22000	270	0.03	0.09	22000	250	0.03	0.09	19000	135	0.03	0.09	19000	120	0.03	0.09
	4	28000	600	0.05	0.20	28000	550	0.05	0.20	25000	500	0.05	0.20	21000	300	0.05	0.20
R0.5	6	21000	400	0.05	0.20	21000	360	0.05	0.20	19000	300	0.05	0.20	16000	200	0.05	0.20
	8	21000	360	0.05	0.15	21000	320	0.05	0.15	19000	270	0.05	0.15	16000	180	0.05	0.15
R0.5	10	18000	300	0.03	0.10	18000	270	0.03	0.10	17000	200	0.03	0.10	14000	150	0.03	0.10
	12	18000	270	0.03	0.10	18000	250	0.03	0.10	17000	180	0.03	0.10	14000	135	0.03	0.10
R0.6	6	20000	600	0.06	0.24	20000	540	0.06	0.24	17000	300	0.06	0.24	14000	200	0.06	0.24
	8	20000	540	0.06	0.24	20000	500	0.06	0.24	17000	270	0.06	0.24	14000	170	0.06	0.24
R0.6	12	16000	300	0.06	0.18	16000	270	0.06	0.18	14000	200	0.06	0.18	11000	150	0.06	0.18
	16	16000	270	0.03	0.12	16000	230	0.03	0.12	14000	175	0.03	0.12	11000	135	0.03	0.12
R0.75	8	17000	600	0.08	0.30	17000	540	0.08	0.30	15000	300	0.08	0.30	12000	250	0.08	0.30
	12	17000	540	0.06	0.24	17000	500	0.06	0.24	15000	275	0.06	0.24	12000	225	0.06	0.24
R0.75	16	13000	300	0.04	0.16	13000	275	0.04	0.16	12000	200	0.04	0.16	9500	150	0.04	0.16
	6	16500	800	0.10	0.40	16500	750	0.10	0.40	16500	560	0.10	0.40	13500	450	0.10	0.40
R1.0	8	16500	800	0.10	0.32	16500	750	0.10	0.32	16500	560	0.10	0.32	13500	450	0.10	0.32
	10	14000	630	0.08	0.30	14000	600	0.08	0.30	13000	450	0.08	0.30	10000	270	0.08	0.30
R1.0	12	14000	630	0.06	0.30	14000	600	0.06	0.30	13000	450	0.06	0.30	10000	270	0.06	0.30
	16	14000	550	0.06	0.24	14000	530	0.06	0.24	13000	400	0.06	0.24	10000	270	0.06	0.24
R1.0	20	11000	360	0.06	0.16	11000	330	0.06	0.16	10000	225	0.06	0.16	8000	175	0.06	0.16

Maximum cutting depth

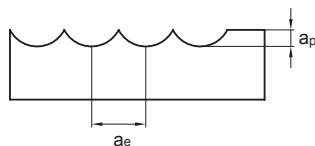

Indexable milling tools

Solid carbide end mills

Cutting parameters for GM series end mills

GM-2BP

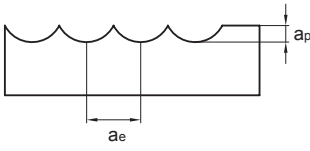
Workpiece material		Cast iron, Carbon steel, Alloy steel ~750N/mm ²				Carbon steel, Alloy steel ~30HRC				Pre-hardened steel, quenched and tempered steel ~40HRC				Stainless steel			
Diameter (mm)	Effective length (mm)	Rotating speed (min ⁻¹)	Feed speed (mm/min)	a _p (mm)	a _e (mm)	Rotating speed (min ⁻¹)	Feed speed (mm/min)	a _p (mm)	a _e (mm)	Rotating speed (min ⁻¹)	Feed speed (mm/min)	a _p (mm)	a _e (mm)	Rotating speed (min ⁻¹)	Feed speed (mm/min)	a _p (mm)	a _e (mm)
R1.25	8	14000	800	0.10	0.32	14000	750	0.10	0.32	14000	560	0.10	0.32	12500	450	0.10	0.32
	12	13000	630	0.06	0.30	13000	600	0.06	0.30	12000	450	0.06	0.30	10000	270	0.06	0.30
	16	13000	550	0.06	0.24	13000	530	0.06	0.24	12000	400	0.06	0.24	10000	270	0.06	0.24
	20	10000	360	0.06	0.16	10000	330	0.06	0.16	8000	225	0.06	0.16	7000	175	0.06	0.16
R1.5	10	12000	800	0.15	0.40	12000	720	0.15	0.40	9500	600	0.15	0.40	7500	400	0.15	0.40
	12	12000	720	0.15	0.40	12000	650	0.15	0.40	9500	540	0.15	0.40	7500	360	0.15	0.40
	16	10000	600	0.15	0.40	10000	540	0.15	0.40	8500	300	0.15	0.40	6500	250	0.15	0.40
	20	10000	600	0.10	0.32	10000	540	0.10	0.32	8500	300	0.10	0.32	6500	250	0.10	0.32
R2.0	10	9000	800	0.20	0.80	9000	720	0.20	0.80	7500	600	0.20	0.80	6000	400	0.20	0.80
	16	9000	800	0.20	0.60	9000	720	0.20	0.60	7500	600	0.20	0.60	6000	400	0.20	0.60
	20	7000	600	0.20	0.40	7000	540	0.20	0.40	6000	400	0.20	0.40	5000	250	0.20	0.40
	25	7000	600	0.15	0.40	7000	540	0.15	0.40	6000	400	0.15	0.40	5000	250	0.15	0.40
R2.5	16	7000	600	0.25	1.00	7000	540	0.25	0.10	6500	500	0.25	1.0	5000	400	0.25	1.00
	25	6000	500	0.25	1.00	6000	450	0.25	1.00	5000	500	0.25	1.00	4000	250	0.25	1.00
Maximum cutting depth																	

1. Please select high-precision machine and tool holder.
2. Please use air blow or cutting liquid with high mist retardant property.
3. Make overhang of tool as short as possible in conditions of non-interference.
4. Reduce feed speed correspondingly when rotating speed is low.

GM-2R

Workpiece material	Cast iron, Nodular cast iron		Carbon steel, Alloy steel ~750N/mm ²		Carbon steel, Alloy steel ~30HRC		Pre-hardened steel, quenched and tempered steel ~40HRC		Stainless steel		Pre-hardened steel, quenched and tempered steel ~50HRC	
	Rotating speed (min ⁻¹)	Feed speed (mm/min)	Rotating speed (min ⁻¹)	Feed speed (mm/min)	Rotating speed (min ⁻¹)	Feed speed (mm/min)	Rotating speed (min ⁻¹)	Feed speed (mm/min)	Rotating speed (min ⁻¹)	Feed speed (mm/min)	Rotating speed (min ⁻¹)	Feed speed (mm/min)
1	20000	200	20000	200	20000	160	20000	160	20000	60	20000	120
2	15000	320	15000	320	15000	290	15000	280	11150	84	13000	180
3	14000	545	14000	545	13000	510	10600	420	7500	120	8500	330
4	10800	560	10800	560	10000	520	8000	430	5500	130	6500	335
5	8200	580	8200	580	7600	540	6400	450	4500	130	5000	355
6	7000	600	7000	600	6400	550	5300	460	3700	140	4200	360
8	5200	600	5200	600	4800	550	4000	460	2800	140	3200	365
10	4200	580	4200	580	3800	540	3200	445	2200	140	2500	350
12	3500	580	3500	580	3200	540	2650	445	1850	140	2100	350

Maximum cutting depth							
<table border="1"> <thead> <tr> <th>Diameter range</th> <th>Cutting depth a_p</th> </tr> </thead> <tbody> <tr> <td>$\varnothing 1 \leq D < \varnothing 3$</td> <td>0.15D</td> </tr> <tr> <td>$\varnothing 3 \leq D$</td> <td>0.3D</td> </tr> </tbody> </table>	Diameter range	Cutting depth a_p	$\varnothing 1 \leq D < \varnothing 3$	0.15D	$\varnothing 3 \leq D$	0.3D	
Diameter range	Cutting depth a_p						
$\varnothing 1 \leq D < \varnothing 3$	0.15D						
$\varnothing 3 \leq D$	0.3D						

- The above table shows the standard value of side milling. When milling slot, 50%~70% of rotating speed and 40%~60% of feed speed stated above are recommended as standard.
- Please select high-precision machine and tool holder.
- Please use air blow or cutting liquid with high mist retardant property.
- Down milling is recommended in the case of side milling.
- When the machine rigidity and workpiece fixture stability is low, vibration and abnormal noise may be generated. Please reduce the rotating speed and feed speed stated above correspondingly.
- Make overhang of tool as short as possible in conditions of non-interference.

GM-4R★GM-4RL/M/X

Workpiece material	Cast iron, Nodular cast iron		Carbon steel, Alloy steel ~750N/mm ²		Carbon steel, Alloy steel ~30HRC		Pre-hardened steel, quenched and tempered steel ~40HRC		Stainless steel		Pre-hardened steel, quenched and tempered steel ~50HRC	
	Rotating speed (min ⁻¹)	Feed speed (mm/min)	Rotating speed (min ⁻¹)	Feed speed (mm/min)	Rotating speed (min ⁻¹)	Feed speed (mm/min)	Rotating speed (min ⁻¹)	Feed speed (mm/min)	Rotating speed (min ⁻¹)	Feed speed (mm/min)	Rotating speed (min ⁻¹)	Feed speed (mm/min)
3	14000	820	14000	820	13000	755	10600	630	7500	145	8500	490
4	10800	840	10800	840	10000	770	8000	640	5500	145	6500	500
5	8200	880	8200	880	7600	810	6400	670	4500	145	5000	530
6	7000	900	7000	900	6400	830	5300	690	3700	160	4200	540
8	5200	890	5200	890	4800	815	4000	680	2800	160	3200	550
10	4200	880	4200	880	3800	810	3200	670	2200	160	2500	520
12	3500	880	3500	880	3200	810	2650	670	1850	160	2100	520
16	2600	680	2600	680	2400	630	2000	525	1400	120	1600	490

Maximum cutting depth	Standard side milling		Slot milling							
	Diagram	Table	Diagram	Table						
		<table border="1"> <thead> <tr> <th>Diameter range</th> <th>Cutting depth a_p</th> </tr> </thead> <tbody> <tr> <td>∅1 < D < ∅3</td> <td>0.15D</td> </tr> <tr> <td>∅3 ≤ D</td> <td>0.3D</td> </tr> </tbody> </table>	Diameter range	Cutting depth a _p	∅1 < D < ∅3	0.15D	∅3 ≤ D	0.3D		
Diameter range	Cutting depth a _p									
∅1 < D < ∅3	0.15D									
∅3 ≤ D	0.3D									

- The above table shows the standard value of side milling. When milling slot, 50%~70% of rotating speed and 40%~60% of feed speed stated above are recommended as standard.
- Please select high-precision machine and tool holder.
- Please use air blow or cutting liquid with high mist retardant property.
- Down milling is recommended in the case of side milling.
- When the machine rigidity and workpiece fixture stability is low, vibration and abnormal noise may be generated. Please reduce the rotating speed and feed speed stated above correspondingly.
- Make overhang of tool as short as possible in conditions of non-interference.

Indexable milling tools

Solid carbide end mills

Cutting parameters for GM series end mills

GM-4W — side cutting

Workpiece material	Cast iron, Nodular cast iron		Carbon steel, Alloy steel ~750N/mm ²		Carbon steel, Alloy steel ~30HRC		Pre-hardened steel, quenched and tempered steel ~40HRC		Stainless steel	
	Diameter (mm)	Rotating speed (min ⁻¹)	Feed speed (mm/min)	Rotating speed (min ⁻¹)	Feed speed (mm/min)	Rotating speed (min ⁻¹)	Feed speed (mm/min)	Rotating speed (min ⁻¹)	Feed speed (mm/min)	Rotating speed (min ⁻¹)
6	6350	760	5300	640	4500	360	3450	280	2650	210
7	5460	760	4550	640	3650	360	3000	280	2250	310
8	4750	760	4000	640	3400	410	2650	310	2000	240
9	4250	760	3540	640	2850	410	2300	310	1750	240
10	3800	760	3200	640	2700	430	2050	330	1600	260
11	3470	760	2900	640	2400	430	1850	330	1450	260
12	3200	770	2250	650	1950	470	1500	360	1150	280
16	2400	770	2000	640	1700	480	1300	360	1000	280
20	1900	760	1600	610	1350	470	1050	350	800	260
Maximum cutting depth										

1. Please select high-precision machine and tool holder.
2. Please use air blow or cutting liquid with high mist retardant property.
3. Down milling is recommended in the case of side milling.
4. When the machine rigidity and workpiece fixture stability is low, vibration and abnormal noise may be generated. Please reduce the rotating speed and feed speed stated above correspondingly.
5. Make overhang of tool as short as possible in conditions of non-interference.

Cutting parameters for GM series end mills

GM-4W—slot cutting

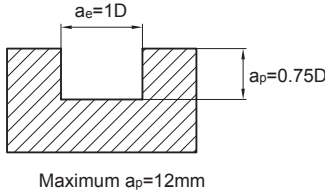
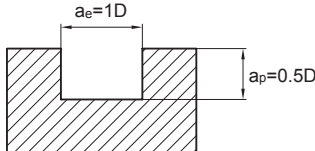
Workpiece material	Cast iron, Nodular cast iron		Carbon steel, Alloy steel ~750N/mm ²		Carbon steel, Alloy steel ~30HRC		Pre-hardened steel, quenched and tempered steel ~40HRC		Stainless steel	
Cutting speed	80~120 m/min		70~100m/min		60~90m/min		40~70m/min		30~60m/min	
Diameter (mm)	Rotating speed (min ⁻¹)	Feed speed (mm/min)	Rotating speed (min ⁻¹)	Feed speed (mm/min)	Rotating speed (min ⁻¹)	Feed speed (mm/min)	Rotating speed (min ⁻¹)	Feed speed (mm/min)	Rotating speed (min ⁻¹)	Feed speed (mm/min)
6	5300	640	4500	540	3700	300	2900	230	2400	190
7	4500	630	3800	540	3200	300	2500	230	2050	190
8	4000	640	3400	540	2800	340	2200	260	1800	220
9	3500	630	3000	540	2450	340	1950	260	1600	220
10	3200	640	2700	540	2250	360	1750	280	1450	230
11	3000	630	2450	540	2050	360	1600	280	1300	230
12	2650	640	2250	540	1850	370	1450	290	1200	240
16	2000	640	1700	540	1400	390	1100	310	900	250
20	1600	640	1350	510	1100	390	900	300	700	230
Maximum cutting depth	 <p>Maximum $a_p=12\text{mm}$</p>									

1. Please select high-precision machine and tool holder.
2. Please use air blow or cutting liquid with high mist retardant property.
3. When the machine rigidity and workpiece fixture stability is low, vibration and abnormal noise may be generated. Please reduce the rotating speed and feed speed stated above correspondingly.
4. Make overhang of tool as short as possible in conditions of non-interference.

Indexable milling tools

Solid carbide end mills

Cutting parameters for GM series end mills

HMX-2E★HMX-2EBL/X

Workpiece material	Pre-hardened steel, Hardened steel 40~50HRC		Hardened steel 50~60HRC		Hardened steel 60~68HRC	
	Rotating speed (min ⁻¹)	Feed speed (mm/min)	Rotating speed (min ⁻¹)	Feed speed (mm/min)	Rotating speed (min ⁻¹)	Feed speed (mm/min)
1	40000	160	40000	160	32000	130
2	40000	400	24000	240	16000	160
3	32000	510	16000	255	11000	175
4	24000	625	12000	310	8000	210
5	19000	685	9500	340	6400	230
6	16000	770	8000	385	5300	255
8	12000	770	6000	385	4000	255
10	9600	770	4800	385	3200	255
12	8000	800	4000	400	2700	270
14	6800	680	3400	340	2300	230
16	6000	600	3000	300	2000	200
18	5300	530	2700	270	1800	180
20	4800	480	2400	240	1600	160
Maximum cutting depth						

1. Please select high-precision and rigidity machine and tool holder.
2. When the machine rigidity and workpiece fixture stability is low, vibration and abnormal noise may be generated. Please reduce the rotating speed and feed speed stated above correspondingly.
3. Please use air blow or MQL (minimum oil mist cooling).
4. Down milling is recommended in the case of side milling.
5. Make overhang of tool as short as possible in conditions of non-interference.

Indexable milling tools

Solid carbide end mills

Cutting parameters for HMX series end mills

HMX-2EFP

Workpiece material	Pre-hardened steel, Hardened steel 40~50HRC		Hardened steel 50~60HRC		Hardened steel 60~68HRC		
	Diameter (mm)	Rotating speed (min ⁻¹)	Feed speed (mm/min)	Rotating speed (min ⁻¹)	Feed speed (mm/min)	Rotating speed (min ⁻¹)	Feed speed (mm/min)
6		16000	1155	8000	460	5300	305
8		12000	1155	6000	460	4000	305
10		9600	1155	4800	460	3200	305
12		8000	1200	4000	480	2700	325
16		6000	900	3000	360	2000	240
20		4800	720	2400	285	1600	195
Maximum cutting depth	<p>Maximum $a_e=1.0\text{mm}$</p>		<p>Maximum $a_e=0.5\text{mm}$</p>		<p>Maximum $a_e=0.3\text{mm}$</p>		

1. Please select high-precision and rigidity machine and tool holder.
2. When the machine rigidity and workpiece fixture stability is low, vibration and abnormal noise may be generated. Please reduce the rotating speed and feed speed stated above correspondingly.
3. Please use air blow or MQL (minimum oil mist cooling).
4. Down milling is recommended in the case of side milling.
5. Make overhang of tool as short as possible in conditions of non-interference.

Indexable milling tools

Solid carbide end mills

Cutting parameters for HMX series end mills

HMX-4E★HMX-4EL★HMX-4EBL/X

Workpiece material	Pre-hardened steel, Hardened steel 40~50HRC		Hardened steel 50~60HRC		Hardened steel 60~68HRC		
	Diameter (mm)	Rotating speed (min ⁻¹)	Feed speed (mm/min)	Rotating speed (min ⁻¹)	Feed speed (mm/min)	Rotating speed (min ⁻¹)	Feed speed (mm/min)
1		40000	320	40000	320	32000	260
2		40000	800	24000	480	16000	320
3		32000	1020	16000	510	11000	350
4		24000	1250	12000	620	8000	420
5		19000	1360	9500	680	6400	460
6		16000	1540	8000	770	5300	510
8		12000	1540	6000	770	4000	510
10		9600	1540	4800	770	3200	510
12		8000	1600	4000	800	2700	540
14		6800	1340	3400	680	2300	460
16		6000	1200	3000	600	2000	400
18		5300	1060	2700	530	1800	360
20		4800	960	2400	480	1600	320
Maximum cutting depth							

1. Please select high-precision and rigidity machine and tool holder.
2. When the machine rigidity and workpiece fixture stability is low, vibration and abnormal noise may be generated. Please reduce the rotating speed and feed speed stated above correspondingly.
3. Please use air blow or MQL (minimum oil mist cooling).
4. Down milling is recommended in the case of side milling.
5. Make overhang of tool as short as possible in conditions of non-interference.

HMX-4EFP

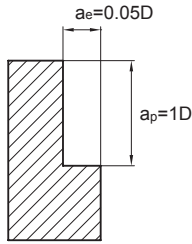
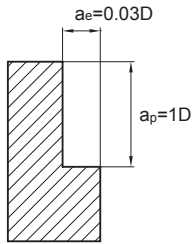
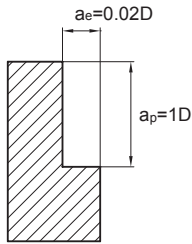
Workpiece material	Pre-hardened steel, Hardened steel 40~50HRC		Hardened steel 50~60HRC		Hardened steel 60~68HRC	
	Rotating speed (min ⁻¹)	Feed speed (mm/min)	Rotating speed (min ⁻¹)	Feed speed (mm/min)	Rotating speed (min ⁻¹)	Feed speed (mm/min)
6	16000	1730	8000	920	5300	610
8	12000	1730	6000	920	4000	610
10	9600	1730	4800	920	3200	610
12	8000	1800	4000	960	2700	650
16	6000	1350	3000	720	2000	480
20	4800	1080	2400	570	1600	390
Maximum cutting depth	 Maximum $a_e=1.0\text{mm}$		 Maximum $a_e=0.5\text{mm}$		 Maximum $a_e=0.3\text{mm}$	

1. Please select high-precision and rigidity machine and tool holder.
2. When the machine rigidity and workpiece fixture stability is low, vibration and abnormal noise may be generated. Please reduce the rotating speed and feed speed stated above correspondingly.
3. Please use air blow or MQL (minimum oil mist cooling).
4. Down milling is recommended in the case of side milling.
5. Make overhang of tool as short as possible in conditions of non-interference.



HMX-6E

Workpiece material	Pre-hardened steel, Hardened steel 40~50HRC		Hardened steel 50~60HRC		Hardened steel 60~68HRC	
cutting speed	300m/min		150m/min		100m/min	
Diameter (mm)	Rotating speed (min ⁻¹)	Feed speed (mm/min)	Rotating speed (min ⁻¹)	Feed speed (mm/min)	Rotating speed (min ⁻¹)	Feed speed (mm/min)
6	16000	1850	8000	925	5300	610
8	12000	1850	6000	925	4000	610
10	9600	1850	4800	925	3200	610
12	8000	1920	4000	960	2700	650
14	6800	1600	3400	815	2300	550
16	6000	1440	3000	720	2000	480
18	5300	1270	2700	635	1800	430
20	4800	1150	2400	575	1600	385
Maximum cutting depth	<p>Maximum $a_e=1.0\text{mm}$</p>		<p>Maximum $a_e=0.5\text{mm}$</p>		<p>Maximum $a_e=0.3\text{mm}$</p>	

1. Please select high-precision and rigidity machine and tool holder.
2. When the machine rigidity and workpiece fixture stability is low, vibration and abnormal noise may be generated. Please reduce the rotating speed and feed speed stated above correspondingly.
3. Please use air blow or MQL (minimum oil mist cooling).
4. Down milling is recommended in the case of side milling.
5. Make overhang of tool as short as possible in conditions of non-interference.

HMX-6EL

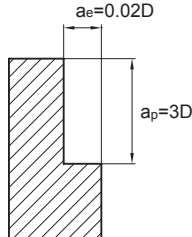
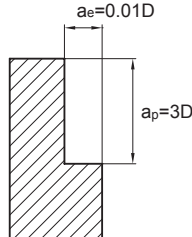
Workpiece material	Pre-hardened steel, Hardened steel 40~50HRC		Hardened steel 50~60HRC		Hardened steel 60~68HRC	
cutting speed	300m/min		150m/min		100m/min	
Diameter (mm)	Rotating speed (min ⁻¹)	Feed speed (mm/min)	Rotating speed (min ⁻¹)	Feed speed (mm/min)	Rotating speed (min ⁻¹)	Feed speed (mm/min)
6	16000	1300	8000	650	5300	430
8	12000	1300	6000	650	4000	430
10	9600	1300	4800	650	3200	430
12	8000	1350	4000	670	2700	460
14	6800	1150	3400	570	2300	380
16	6000	1000	3000	500	2000	340
18	5300	890	2700	450	1800	300
20	4800	800	2400	400	1600	270
Maximum cutting depth	 <p>Maximum $a_e = 0.3\text{mm}$</p>					

1. Please select high-precision and rigidity machine and tool holder.
2. When the machine rigidity and workpiece fixture stability is low, vibration and abnormal noise may be generated. Please reduce the rotating speed and feed speed stated above correspondingly.
3. Please use air blow or MQL (minimum oil mist cooling).
4. Down milling is recommended in the case of side milling.
5. Make overhang of tool as short as possible in conditions of non-interference.

HMX-2EP

Workpiece material		Pre-hardened steel, Hardened steel 40~50HRC			Hardened steel 50~60HRC		
Diameter (mm)	Effective length (mm)	Rotating speed (min ⁻¹)	Feed speed (mm/min)	a _p (mm)	Rotating speed (min ⁻¹)	Feed speed (mm/min)	a _p (mm)
0.5	4	21000	100	0.009	17000	50	0.009
	6	20000	75	0.006	15000	35	0.007
	8	20000	50	0.002	15000	20	0.003
0.8	4	20000	200	0.022	14000	100	0.011
	6	18000	150	0.014	14000	75	0.009
	8	18000	100	0.01	14000	50	0.006
	10	18000	75	0.007	14000	30	0.004
	12	18000	50	0.005	14000	20	0.003
1.0	4	17000	400	0.035	12000	100	0.016
	6	17000	400	0.03	12000	100	0.014
	8	15000	300	0.02	10000	75	0.01
	10	15000	250	0.015	10000	50	0.008
	12	12000	150	0.01	10000	50	0.006
	14	12000	100	0.007	10000	30	0.004
	16	12000	75	0.005	10000	20	0.003
1.2	6	14000	400	0.03	10000	100	0.017
	8	12000	300	0.03	10000	100	0.014
	10	12000	300	0.02	10000	75	0.01
	12	10000	200	0.01	10000	50	0.00
1.5	6	12000	400	0.06	8000	200	0.028
	8	10000	300	0.04	7000	150	0.021
	10	10000	300	0.03	7000	150	0.017
	12	10000	300	0.025	7000	100	0.01
	14	10000	250	0.02	7000	75	0.005
	16	10000	200	0.015	7000	50	0.003
2.0	6	9000	400	0.13	6000	300	0.07
	8	9000	400	0.11	6000	300	0.06
	10	7000	300	0.10	6000	200	0.05
	12	7000	300	0.06	6000	200	0.03
	14	7000	250	0.04	6000	150	0.015
	16	7000	200	0.02	6000	100	0.008

Maximum cutting depth

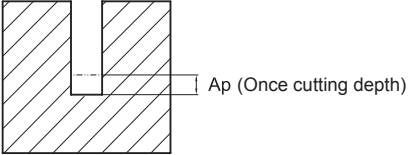

Indexable milling tools

Solid carbide end mills

Cutting parameters for HMX series end mills

HMX-2EP

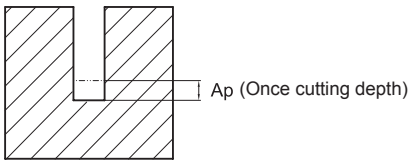
Workpiece material		Pre-hardened steel, Hardened steel 40~50HRC			Hardened steel 50~60HRC		
Diameter (mm)	Effective length (mm)	Rotating speed (min ⁻¹)	Feed speed (mm/min)	a _p (mm)	Rotating speed (min ⁻¹)	Feed speed (mm/min)	a _p (mm)
2.5	8	8000	400	0.16	5000	300	0.08
	10	8000	400	0.14	5000	300	0.07
	12	8000	400	0.09	5000	300	0.05
	14	6000	300	0.07	5000	200	0.03
	16	6000	300	0.05	5000	200	0.025
	18	6000	300	0.04	5000	150	0.02
	20	6000	300	0.02	5000	100	0.01
3.0	6	7000	400	0.18	5000	300	0.10
	8	7000	400	0.15	5000	300	0.08
	10	7000	400	0.12	5000	300	0.06
	12	7000	400	0.10	5000	300	0.05
	14	6000	300	0.08	5000	200	0.04
	16	6000	300	0.06	5000	200	0.03
	18	6000	300	0.05	5000	200	0.025
	20	6000	250	0.04	5000	150	0.01
4.0	12	4500	400	0.16	4000	300	0.08
	16	4500	400	0.14	4000	300	0.06
	20	4500	300	0.10	4000	300	0.04
	25	4500	300	0.08	4000	300	0.03
5.0	16	4000	400	0.19	3000	300	0.09
	25	4000	400	0.15	3000	300	0.06
Maximum cutting depth							

Indexable
milling toolsSolid carbide
end mills

Cutting parameters for HMX series end mills

1. Please select high-precision machine and tool holder.
2. Please use air blow or cutting liquid with high mist retardant property.
3. Make overhang of tool as short as possible in conditions of non-interference.
4. Reduce feed speed correspondingly when rotating speed is low.

HMX-2ES

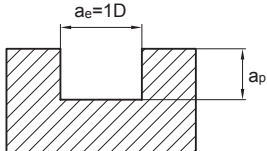
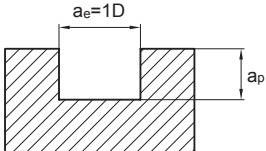
Workpiece material	Pre-hardened steel, Hardened steel 40~50HRC		Hardened steel 50~60HRC													
	Rotating speed (min ⁻¹)	Feed speed (mm/min)	Rotating speed (min ⁻¹)	Feed speed (mm/min)												
0.3	23000	30	16500	25												
0.4	17500	30	12500	25												
0.5	14000	30	10000	25												
0.6	11500	30	8450	25												
0.7	10000	30	7500	25												
0.8	8750	30	6350	25												
0.9	8000	30	5500	25												
1.0	7000	30	5050	25												
1.5	5050	40	3550	25												
2.0	3950	40	2750	25												
2.5	3500	45	2500	30												
3.0	2750	45	2000	30												
Maximum cutting depth	 <table border="1" data-bbox="660 998 853 1110"> <thead> <tr> <th>Diameter range</th> <th>Cutting depth a_p</th> </tr> </thead> <tbody> <tr> <td>D < Ø1</td> <td>0.02D</td> </tr> <tr> <td>Ø1 ≤ D ≤ Ø3</td> <td>0.05D</td> </tr> </tbody> </table>		Diameter range	Cutting depth a _p	D < Ø1	0.02D	Ø1 ≤ D ≤ Ø3	0.05D	 <table border="1" data-bbox="1198 998 1391 1110"> <thead> <tr> <th>Diameter range</th> <th>Cutting depth a_p</th> </tr> </thead> <tbody> <tr> <td>D < Ø1</td> <td>0.01D</td> </tr> <tr> <td>Ø1 ≤ D ≤ Ø3</td> <td>0.02D</td> </tr> </tbody> </table>		Diameter range	Cutting depth a _p	D < Ø1	0.01D	Ø1 ≤ D ≤ Ø3	0.02D
Diameter range	Cutting depth a _p															
D < Ø1	0.02D															
Ø1 ≤ D ≤ Ø3	0.05D															
Diameter range	Cutting depth a _p															
D < Ø1	0.01D															
Ø1 ≤ D ≤ Ø3	0.02D															

1. Please select high-precision machine and tool holder.
2. Please use air blow or cutting liquid with high mist retardant property.
3. Make overhang of tool as short as possible in conditions of non-interference.
4. Reduce feed speed correspondingly when rotating speed is low.

HMX-2B★HMX-2BL/M/X★HMX-2BFP

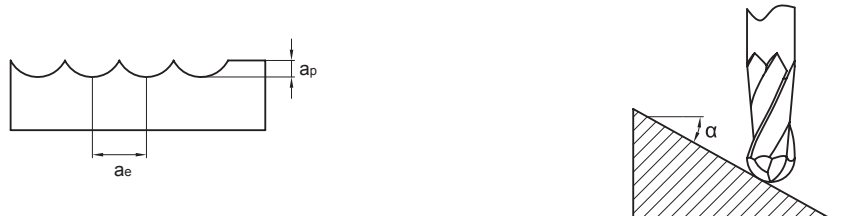
Workpiece material	Pre-hardened steel, Hardened steel 40~50HRC				Hardened steel 50~60HRC				Hardened steel 60~68HRC			
	Rotating speed (min ⁻¹)	Feed speed (mm/min)	a _p (mm)	a _e (mm)	Rotating speed (min ⁻¹)	Feed speed (mm/min)	a _p (mm)	a _e (mm)	Rotating speed (min ⁻¹)	Feed speed (mm/min)	a _p (mm)	a _e (mm)
R0.5	40000	1900	0.01	0.05	36000	1500	0.01	0.05	32000	1400	0.01	0.05
R1.0	33000	3100	0.02	0.075	26000	2100	0.02	0.075	24000	2000	0.02	0.075
R1.5	29000	4100	0.03	0.1	23000	2900	0.03	0.1	21000	2600	0.03	0.1
R2.0	22000	3900	0.04	0.15	17000	2500	0.04	0.15	15500	2100	0.04	0.15
R2.5	17500	3500	0.05	0.15	13500	2200	0.05	0.15	13000	2000	0.05	0.15
R3.0	15000	3100	0.06	0.2	11500	1700	0.06	0.2	10500	1500	0.06	0.2
R4.0	11000	2500	0.08	0.25	8600	1600	0.08	0.25	8000	1400	0.08	0.25
R5.0	9000	2000	0.1	0.3	7000	1400	0.1	0.3	6000	1200	0.1	0.3
R6.0	7500	1800	0.1	0.35	5700	1300	0.1	0.35	5300	1200	0.1	0.35
R8.0	5500	1800	0.1	0.4	4300	1300	0.1	0.4	4000	1200	0.1	0.4
R10.0	4500	1800	0.1	0.5	3500	1300	0.1	0.5	3200	1200	0.1	0.5
Maximum cutting depth												

1. Please select high-precision and rigidity machine and tool holder.
2. Above table shows the standard for operations with little change of machining load, such as contour machining. When the machine rigidity and workpiece fixture stability is low, vibration and abnormal noise may be generated. Please reduce the rotating speed and feed speed stated above correspondingly.
3. Please use air blow or MQL (minimum oil mist cooling).
4. When inclination angle α is more than 15°, please reduce rotating speed and feed speed to 50%~80% of the speeds stated in the table.
5. Make overhang of tool as short as possible in conditions of non-interference.

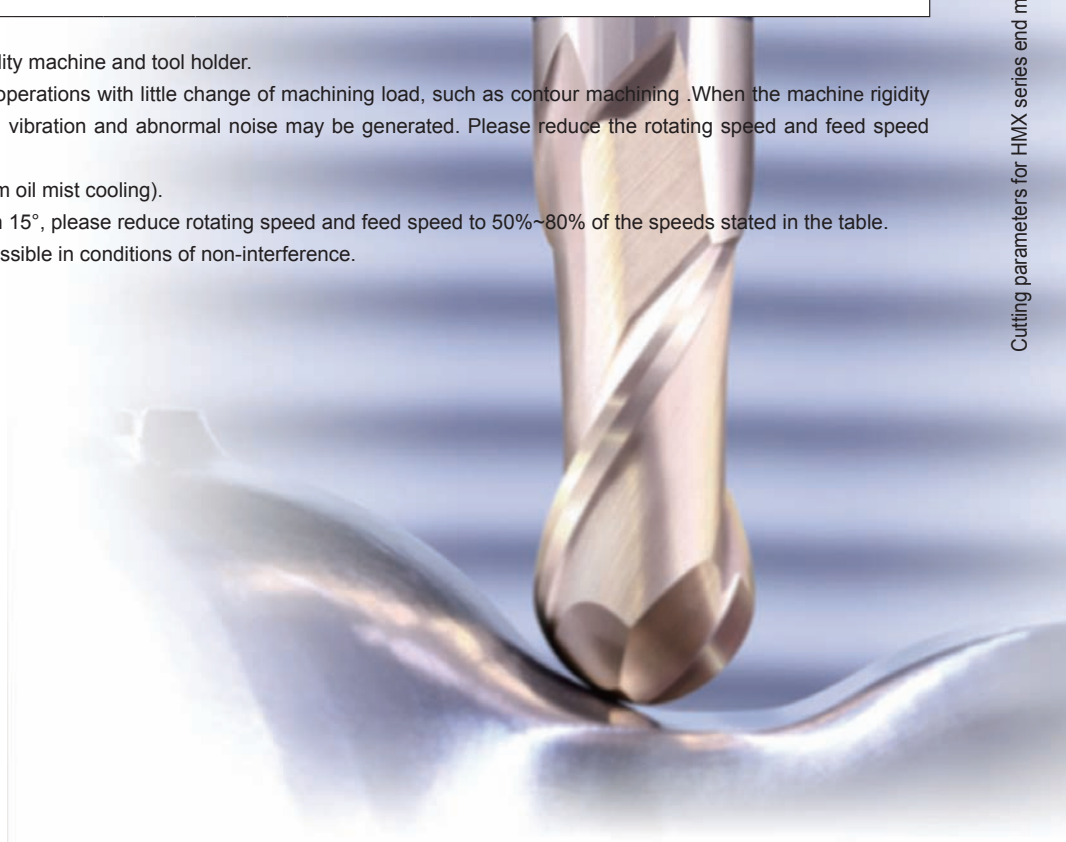

Indexable milling tools

Solid carbide end mills

Cutting parameters for HMX series end mills

HMX-4B★HMX-4BL

Workpiece material	Pre-hardened steel, Hardened steel 40~50HRC				Hardened steel 50~60HRC				Hardened steel 60~68HRC			
	Rotating speed (min ⁻¹)	Feed speed (mm/min)	a _p (mm)	a _e (mm)	Rotating speed (min ⁻¹)	Feed speed (mm/min)	a _p (mm)	a _e (mm)	Rotating speed (min ⁻¹)	Feed speed (mm/min)	a _p (mm)	a _e (mm)
R1.5	29000	6560	0.03	0.1	22800	4560	0.03	0.1	21100	4240	0.03	0.1
R2.0	22000	6250	0.04	0.15	17100	4000	0.04	0.15	15800	3520	0.04	0.15
R2.5	17400	5600	0.05	0.15	13600	3520	0.05	0.15	12700	3200	0.05	0.15
R3.0	14500	5000	0.06	0.2	11400	3000	0.06	0.2	10600	2500	0.06	0.2
R4.0	10900	4200	0.08	0.25	8550	2500	0.08	0.25	7950	2250	0.08	0.25
R5.0	8700	3500	0.1	0.3	6850	2200	0.1	0.3	6350	2000	0.1	0.3
R6.0	7250	3000	0.1	0.35	5700	2000	0.1	0.35	5300	1900	0.1	0.35
R8.0	5450	3000	0.1	0.4	4280	2000	0.1	0.4	4000	1900	0.1	0.4
R10.0	4350	3000	0.1	0.5	3425	2000	0.1	0.5	3200	1900	0.1	0.5

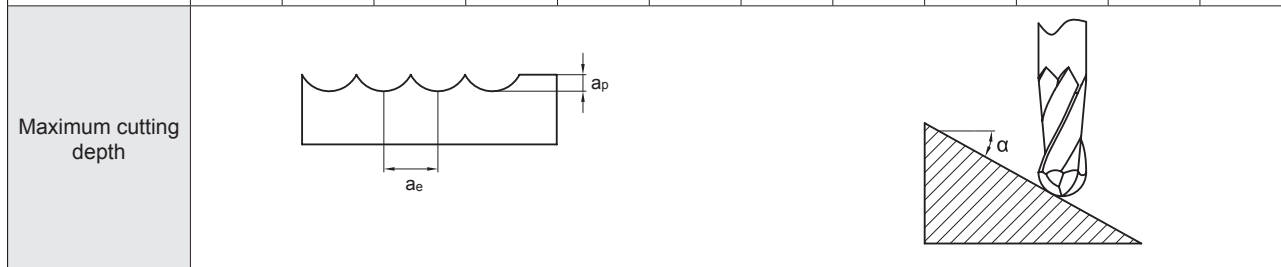

1. Please select high-precision and rigidity machine and tool holder.
2. Above table shows the standard for operations with little change of machining load, such as contour machining. When the machine rigidity and workpiece fixture stability is low, vibration and abnormal noise may be generated. Please reduce the rotating speed and feed speed stated above correspondingly.
3. Please use air blow or MQL (minimum oil mist cooling).
4. When inclination angle α is more than 15° , please reduce rotating speed and feed speed to 50%~80% of the speeds stated in the table.
5. Make overhang of tool as short as possible in conditions of non-interference.

HMX-2BS

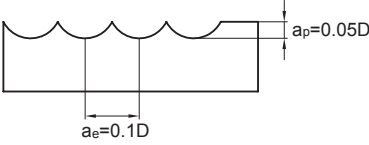
Workpiece material	Pre-hardened steel, Hardened steel 40~50HRC		Hardened steel 50~60HRC	
	Rotating speed (min ⁻¹)	Feed speed (mm/min)	Rotating speed (min ⁻¹)	Feed speed (mm/min)
R0.15	25000	135	25000	115
R0.2	25000	140	25000	120
R0.25	25000	150	25000	130
R0.3	25000	175	24000	150
R0.35	25000	190	24000	150
R0.4	24000	210	18000	140
R0.45	21000	210	15000	140
R0.5	19000	210	14000	140
R1.0	9500	210	7200	140
R1.5	6400	210	4800	140
Maximum cutting depth				

1. Please select high-precision machine and tool holder.
2. Please use air blow or cutting liquid with high mist retardant property.
3. Make overhang of tool as short as possible in conditions of non-interference.
4. Reduce feed speed correspondingly when rotating speed is low.

HMX-2BP

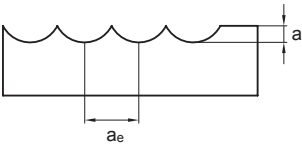
Workpiece material		Pre-hardened steel, Hardened steel 40~50HRC				Hardened steel 50~60HRC			
Diameter (mm)	Effective length (mm)	Rotating speed (min ⁻¹)	Feed speed (mm/min)	a _p (mm)	a _e (mm)	Rotating speed (min ⁻¹)	Feed speed (mm/min)	a _p (mm)	a _e (mm)
R0.25	4	27000	200	0.01	0.01	27000	100	0.01	0.01
	6	20000	150	0.005	0.01	20000	75	0.005	0.005
R0.3	4	24000	200	0.03	0.06	17000	150	0.02	0.04
	6	20000	150	0.02	0.03	17000	150	0.01	0.02
	8	20000	120	0.02	0.03	17000	120	0.01	0.02
R0.4	4	21000	300	0.04	0.08	14500	200	0.03	0.08
	6	19000	200	0.02	0.04	12000	150	0.02	0.04
	8	17000	150	0.02	0.04	12000	100	0.02	0.04
	10	17000	135	0.02	0.03	12000	75	0.01	0.02
R0.5	4	21000	300	0.05	0.10	14500	200	0.05	0.10
	6	16000	200	0.05	0.10	11500	150	0.05	0.10
	8	16000	180	0.03	0.05	11500	135	0.03	0.05
	10	14000	150	0.01	0.03	9800	100	0.01	0.03
	12	14000	135	0.01	0.03	9800	75	0.01	0.03
R0.6	6	14000	200	0.06	0.12	9500	175	0.06	0.12
	8	14000	180	0.06	0.12	9500	150	0.06	0.12
	12	11000	150	0.04	0.06	7500	100	0.03	0.06
	16	11000	135	0.02	0.04	7500	75	0.02	0.03
R0.75	8	12000	250	0.08	0.15	8000	200	0.08	0.15
	12	12000	225	0.06	0.15	8000	175	0.06	0.15
	16	9500	150	0.01	0.05	6500	100	0.01	0.03
R1.0	6	13500	400	0.10	0.20	7500	225	0.10	0.20
	8	13500	400	0.10	0.16	7500	225	0.10	0.16
	10	10000	275	0.08	0.16	5500	175	0.08	0.16
	12	10000	275	0.06	0.16	5500	175	0.06	0.16
	16	10000	250	0.02	0.10	5500	150	0.02	0.10
	20	8000	175	0.02	0.05	5500	125	0.01	0.05
Maximum cutting depth									

Indexable milling tools

Solid carbide end mills

Cutting parameters for HMX series end mills

HMX-2BP

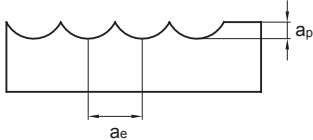
Workpiece material		Pre-hardened steel, Hardened steel 40~50HRC				Hardened steel 50~60HRC			
Diameter (mm)	Effective length (mm)	Rotating speed (min ⁻¹)	Feed speed (mm/min)	a _p (mm)	a _e (mm)	Rotating speed (min ⁻¹)	Feed speed (mm/min)	a _p (mm)	a _e (mm)
R1.25	8	12500	400	0.10	0.16	7000	225	0.10	0.16
	12	9000	275	0.06	0.16	5000	175	0.06	0.16
	16	9000	250	0.02	0.10	5000	150	0.02	0.10
	20	5500	175	0.02	0.05	5000	125	0.01	0.05
R1.5	10	7500	400	0.10	0.30	4000	200	0.10	0.30
	12	7500	360	0.10	0.30	4000	180	0.10	0.30
	16	6500	250	0.05	0.20	3000	150	0.05	0.20
	20	6500	250	0.02	0.10	3000	150	0.02	0.05
R2.0	10	6000	400	0.20	0.40	3000	200	0.20	0.40
	16	6000	400	0.10	0.32	3000	200	0.20	0.20
	20	5000	250	0.10	0.20	2500	100	0.10	0.20
	25	5000	250	0.10	0.20	2500	100	0.10	0.10
R2.5	16	5000	400	0.25	0.50	3000	200	0.2	0.2
	25	4000	250	0.25	0.50	3000	100	0.20	0.2
Maximum cutting depth									

1. Please select high-precision machine and tool holder.
2. Please use air blow or cutting liquid with high mist retardant property.
3. Make overhang of tool as short as possible in conditions of non-interference.
4. Reduce feed speed correspondingly when rotating speed is low.

HMX-4R★HMX-4RBL/M/X★HMX-4RP★HMX-4RF

Workpiece material	Pre-hardened steel, Hardened steel 40~50HRC		Hardened steel 50~60HRC		Hardened steel 60~68HRC	
Cutting speed	300m/min		150m/min		100m/min	
Diameter (mm)	Rotating speed (min ⁻¹)	Feed speed (mm/min)	Rotating speed (min ⁻¹)	Feed speed (mm/min)	Rotating speed (min ⁻¹)	Feed speed (mm/min)
3	32000	1225	16000	610	11000	420
4	24000	1500	12000	745	8000	500
5	19000	1630	9500	815	6400	550
6	16000	1850	8000	925	5300	610
8	12000	1850	6000	925	4000	610
10	9600	1850	4800	925	3200	610
12	8000	1920	4000	960	2700	648
16	6000	1440	3000	720	2000	480
Maximum cutting depth	<p>Maximum $a_e=1.0\text{mm}$</p>		<p>Maximum $a_e=0.5\text{mm}$</p>		<p>Maximum $a_e=0.3\text{mm}$</p>	

1. Please select high-precision and rigidity machine and tool holder.
2. When the machine rigidity and workpiece fixture stability is low, vibration and abnormal noise may be generated. Please reduce the rotating speed and feed speed stated above correspondingly.
3. Please use air blow or MQL (minimum oil mist cooling).
4. Down milling is recommended in the case of side milling.
5. Make overhang of tool as short as possible in conditions of non-interference.

HMX-6R-MAX

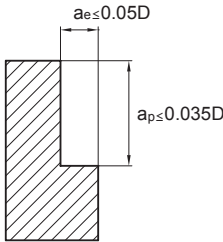
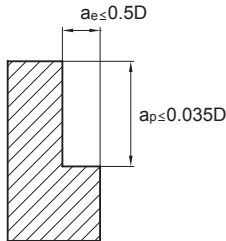
Workpiece material	Pre-hardened steel, Hardened steel 40~50HRC		Hardened steel 50~60HRC	
Cutting speed	100m/min		80m/min	
Diameter (mm)	Rotating speed (min ⁻¹)	Feed speed (mm/min)	Rotating speed (min ⁻¹)	Feed speed (mm/min)
6	5300	3200	4200	2600
8	4000	3200	3200	2600
10	3200	3200	2600	2600
12	2600	3200	2200	2600
16	2000	3600	1600	2800
20	1600	3600	1300	2800
Maximum cutting depth				

1. Please select high-precision and rigidity machine and tool holder.
2. When the machine rigidity and workpiece fixture stability is low, vibration and abnormal noise may be generated. Please reduce the rotating speed and feed speed stated above correspondingly.
3. Please use air blow or MQL (minimum oil mist cooling).
4. Make overhang of tool as short as possible in conditions of non-interference.

TM-4R★TM-4RP★TM-4B

Workpiece material	α phase titanium alloy(TA)		α+β phase titanium alloy(TC)		β phase titanium alloy(TB)	
	Diameter (mm)	Cutting speed (m/min)	Feed (mm/r)	Cutting speed (m/min)	Feed (mm/r)	Cutting speed (m/min)
6.0-10.0	40~120	0.16~0.36	30~100	0.16~0.36	30~60	0.12~0.28
10.0-14.0		0.20~0.40		0.20~0.40		0.16~0.32
14.0-20.0		0.30~0.48		0.30~0.48		0.20~0.40
20.0-25.0		0.32~0.60		0.32~0.60		0.24~0.48

Note: High temperature alloy endmills' cutting data please referring to β phase titanium alloy recommended cutting data.

Indexable
milling tools

Solid carbide
end mills

Cutting parameters for TM series end mills



TM-4E

Workpiece material	Titanium alloy	
Diameter (mm)	Rotating speed (min^{-1})	Feed speed (mm/z)
6	2654	0.03~0.05
8	1990	0.035~0.058
10	1592	0.036~0.061
12	1327	0.038~0.065
14	1137	0.038~0.065
16	995	0.04~0.072
20	796	0.041~0.09
25	637	0.043~0.10
Maximum cutting depth		

1. The above table shows the standard value of side milling. When milling slot, 80%~100% of rotating speed and 60%~80% of feed speed stated above are recommended as standard.
2. Please select high rigidity and precision machine and tool holder, please use non-water-soluble cutting liquid.
3. Please adjust rotating speed and feed speed according to the cutting depth and machine rigidity, down milling is recommended.
4. Make overhang of tool as short as possible in conditions of non-interference.

TM-5R

Workpiece material	Titanium alloy	
Diameter (mm)	Rotating speed (min ⁻¹)	Feed speed (mm/z)
6	4246	0.03~0.05
8	3185	0.035~0.058
10	2548	0.036~0.061
12	2123	0.038~0.065
14	1820	0.038~0.065
16	1592	0.04~0.072
20	1274	0.041~0.09
25	1019	0.043~0.10

Maximum cutting depth	<p>Diagram showing side milling parameters: $a_e = 0.1D$ and $a_p = 1.5D$.</p>	<p>Diagram showing down milling parameters: $a_e = 1D$ and $a_p = 0.15D$.</p>
-----------------------	--	---

1. The above table shows the standard value of side milling. When milling slot, 80%~100% of rotating speed and 60%~80% of feed speed stated above are recommended as standard.
2. Please select high rigidity and precision machine and tool holder, please use non-water-soluble cutting liquid.
3. Please adjust rotating speed and feed speed according to the cutting depth and machine rigidity, down milling is recommended.
4. Make overhang of tool as short as possible in conditions of non-interference.

TM-6R

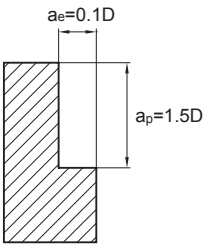
Workpiece material	Titanium alloy	
Diameter (mm)	Rotating speed (min ⁻¹)	Feed speed (mm/z)
10	1273	0.02~0.045
12	1061	0.028~0.048
14	910	0.03~0.055
16	796	0.04~0.07
20	636	0.042~0.08
25	510	0.045~0.09
Maximum cutting depth	 <p>The diagram illustrates the maximum cutting depth parameters for a side mill. It shows a cross-section of a workpiece being milled. The axial cutting depth is labeled as $a_e = 0.1D$, where D is the diameter of the mill. The radial cutting depth is labeled as $a_p = 1.5D$.</p>	

1. The above table shows the standard value of side milling. When milling slot, please apply end mills with 4 flutes or 5 flutes.
2. Please select high rigidity and precision machine and tool holder, please use non-water-soluble cutting liquid.
3. Please adjust rotating speed and feed speed according to the cutting depth and machine rigidity, down milling is recommended.
4. Make overhang of tool as short as possible in conditions of non-interference.

NM-2E

Workpiece material	Copper, Alloy of copper	
Diameter (mm)	Rotating speed (min ⁻¹)	Feed speed (mm/min)
1	40000	1800
2	30000	2500
3	20000	2300
4	15000	2000
5	12000	1500
6	10000	1400
8	8000	1000
10	6500	900
12	5500	850

Maximum cutting depth	Diagram 1	Diagram 2
	<p>Diagram 1 shows a side milling operation with a cutting depth $a_e = 0.1D$ and a feed per tooth $a_p = 1D$. The maximum a_e is 1.0mm.</p>	<p>Diagram 2 shows a side milling operation with a cutting depth $a_e = 1D$ and a feed per tooth $a_p = 0.1D$. The maximum a_p is 1.0mm.</p>

1. The above table shows the standard value of side milling. When milling slot, 70% of feed speed stated above are recommend as standard.
2. Please select high-rigidity and high-precision machine and tool holder. When the machine rigidity and workpiece fixture stability is low, vibration and abnormal noise may be generated. Please reduce the rotating speed and feed speed above correspondingly.
3. When cutting depth is smaller, rotating speed and feed speed can be increased correspondingly.
4. Please select water-soluble cutting liquid.
5. Down milling is recommended in the case of side milling.
6. Make overhang of tool as short as possible in condition of non-interference.

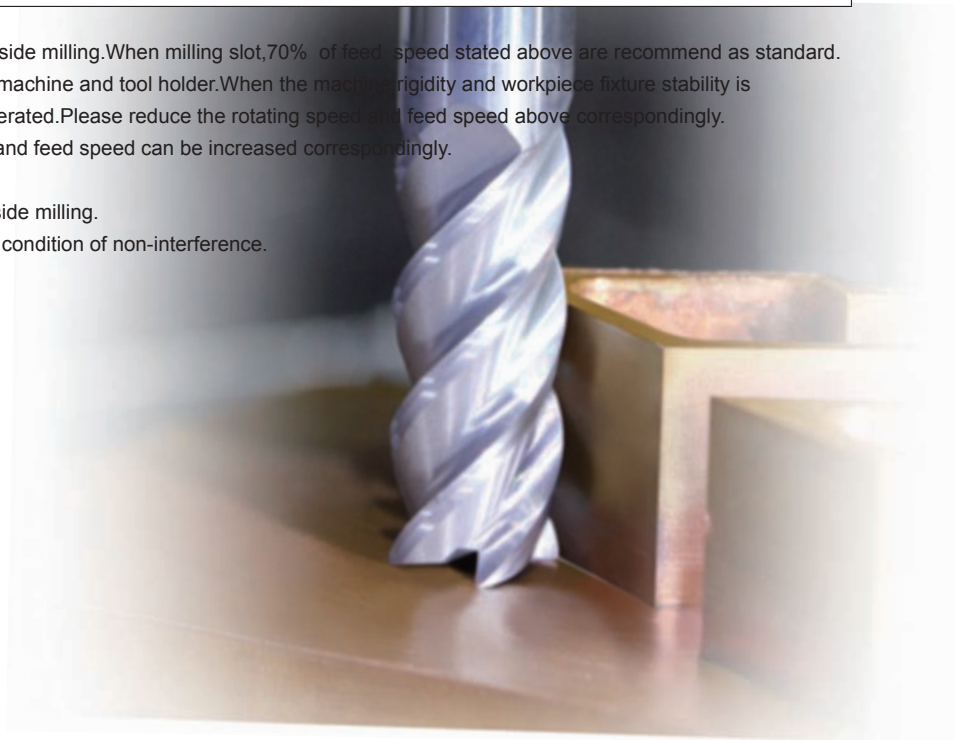

NM-4E

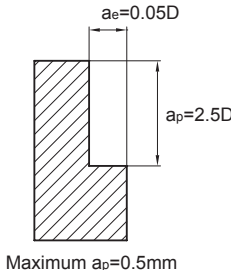
Workpiece material	Copper, Alloy of copper	
Diameter (mm)	Rotating speed (min ⁻¹)	Feed speed (mm/min)
3	10600	250
4	8000	300
5	6500	400
6	5300	400
8	4000	450
10	3500	450
12	3000	450
Maximum cutting depth	 <p style="text-align: center;">Maximum $a_p = 0.5\text{mm}$</p>	

1. Please select high-precision and rigidity machine and tool holder. When the machine rigidity and workpiece fixture stability is low, vibration and abnormal noise may be generated. Please reduce the rotating speed and feed speed above correspondingly.
2. When cutting depth is small, rotating speed and feed speed can be increased correspondingly.
3. Please select water-soluble cutting liquid.
4. Down milling is recommended in the case of side milling.
5. Make overhang of tool as short as possible in condition of non-interference.

NM-2EP

Workpiece material		Copper, Alloy of copper		
Diameter (mm)	Effective length(mm)	Rotating speed (min ⁻¹)	Feed speed (mm/min)	a _p (mm)
0.5	4	40000	800	0.004
	6	40000	700	0.002
	8	40000	500	0.001
0.8	4	40000	1000	0.02
	6	40000	1000	0.015
	8	40000	800	0.01
	10	40000	600	0.005
1.0	4	40000	1800	0.04
	6	40000	1500	0.04
	8	40000	1500	0.03
	10	30000	1000	0.02
	12	30000	800	0.015
	14	30000	600	0.01
1.5	8	40000	2000	0.09
	16	20000	1000	0.03
2.0	6	40000	2400	0.18
	8	40000	2200	0.15
	10	40000	2000	0.12
	12	30000	1500	0.10
	14	30000	1200	0.08
	16	30000	1000	0.06
2.5	10	40000	2500	0.15
	20	20000	1000	0.08
3.0	10	20000	2500	0.20
	20	20000	2000	0.12
4.0	16	15000	1800	0.25
	25	15000	1200	0.15
5.0	16	12000	2000	0.40
	25	12000	1500	0.35

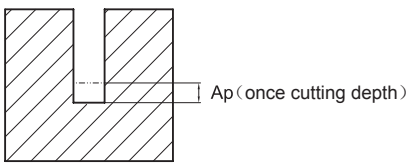

Maximum cutting depth

1. Please select high-precision machine and tool holder.
2. Please select water-soluble cutting liquid.
3. Make overhang of tool as short as possible in condition of non-interference.
4. Reduce feed speed correspondingly when rotating speed is low.

NM-2B

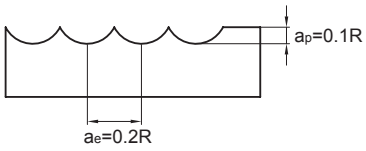
Workpiece material	Copper, Alloy of copper	
Diameter (mm)	Rotating speed (min ⁻¹)	Feed speed (mm/min)
R0.5	40000	900
R0.75	32000	800
R1.0	24000	870
R1.25	19000	800
R1.5	16000	850
R1.75	14000	850
R2.0	12000	900
R2.5	9600	900
R3.0	8000	1200
R4.0	7000	1500
R5.0	4800	1300
R6.0	4000	1200
Maximum cutting depth		

1. Please select high-precision and rigidity machine and tool holder. When the machine rigidity and workpiece fixture stability is low, vibration and abnormal noise may be generated. Please reduce the rotating speed and feed speed above correspondingly.
2. When cutting depth is small, rotating speed and feed speed can be increased correspondingly.
3. Please select water-soluble cutting liquid.
4. Make overhang of tool as short as possible in condition of non-interference.

NM-2BP

Workpiece material		Copper, Alloy of copper			
Diameter (mm)	Effective length(mm)	Rotating speed (min ⁻¹)	Feed speed (mm/min)	a _p (mm)	a _e (mm)
R0.25	4	40000	750	0.01	0.025
	6	36000	500	0.008	0.02
R0.3	4	40000	900	0.012	0.03
	6	40000	750	0.010	0.02
	8	30000	400	0.008	0.01
R0.4	4	40000	1050	0.016	0.04
	6	40000	800	0.012	0.03
	8	40000	500	0.01	0.02
	10	30000	400	0.008	0.01
R0.5	4	40000	1050	0.02	0.05
	6	40000	800	0.016	0.04
	8	40000	500	0.014	0.03
	10	33000	400	0.012	0.02
	12	35000	300	0.010	0.010
R0.75	8	40000	900	0.03	0.075
	16	20000	400	0.015	0.04
R1.0	6	40000	1100	0.04	0.10
	8	40000	900	0.034	0.08
	10	40000	750	0.028	0.065
	12	40000	500	0.022	0.05
	16	30000	400	0.018	0.04
	20	20000	300	0.012	0.03
R1.5	10	40000	1100	0.06	0.15
	20	32000	600	0.03	0.08
R2.0	10	32000	1100	0.08	0.20
	16	32000	900	0.06	0.16
	20	32000	600	0.04	0.12
	25	20000	400	0.02	0.08
R2.5	16	25000	1250	0.10	0.25
	25	20000	900	0.06	0.12

The diagram illustrates a wavy cutting surface. A vertical dimension line on the right indicates the maximum cutting depth, labeled as a_p . A horizontal dimension line at the bottom indicates the maximum cutting width, labeled as a_e .

1. Please select high-precision machine and tool holder.
2. Please select water-soluble cutting liquid.
3. Make overhang of tool as short as possible in condition of non-interference.
4. Reduce feed speed correspondingly when rotating speed is low.

AL-2E★AL-2EL

Workpiece material	Aluminum alloy		Silicon aluminum alloy Si≤10%		
	Diameter (mm)	Rotating speed (min ⁻¹)	Feed speed (mm/min)	Rotating speed (min ⁻¹)	Feed speed (mm/min)
1		40000	650	40000	500
2		40000	950	32000	750
3		26500	1500	21000	1100
4		20000	1600	16000	1250
5		16000	1500	13000	1100
6		13000	1250	10600	1000
8		10000	1400	8000	1100
10		8000	1600	6500	1250
12		6600	1650	5300	1300
14		5700	1700	4600	1350
16		5000	1700	4000	1350
18		4400	1700	3500	1350
20		4000	1700	3200	1350
Maximum cutting depth					

- 1.The above table shows the reference value of side milling. The feed speed in slot milling is 70% of the reference value stated in the table.
- 2.Please select high rigidity and precision machine and tool holder. Vibration and abnormal noise may be generated if the machine rigidity and workpiece fixture stability is low. Please reduce the rotating speed and feed speed stated above correspondingly.
- 3.It is possible to increase the rotating speed and feed speed correspondingly if the cutting depth is low.
- 4.Please use water-soluble cutting liquid.
- 5.Down milling is recommended in the case of side milling.
- 6.Make overhang of tool as short as possible in conditions of non-interference.

AL-3E★AL-3EL

Workpiece material	Aluminum alloy		Silicon aluminum alloy Si≤10%		
	Diameter (mm)	Rotating speed (min ⁻¹)	Feed speed (mm/min)	Rotating speed (min ⁻¹)	Feed speed (mm/min)
1		40000	800	40000	600
2		40000	1200	32000	900
3		26500	1800	21000	1300
4		20000	2000	16000	1500
5		16000	1750	13000	1300
6		13000	1500	10600	1200
8		10000	1650	8000	1300
10		8000	1900	6500	1500
12		6600	1950	5300	1550
14		5700	2000	4600	1600
16		5000	2000	4000	1600
18		4400	2000	3500	1600
20		4000	2000	3200	1600
Maximum cutting depth					

- 1.The above table shows the reference value of side milling. The feed speed in slot milling is 70% of the reference value stated in the table.
- 2.Please select high rigidity and precision machine and tool holder. Vibration and abnormal noise may be generated if the machine rigidity and workpiece fixture stability is low. Please reduce the rotating speed and feed speed stated above correspondingly.
- 3.It is possible to increase the rotating speed and feed speed correspondingly if the cutting depth is low.
- 4.Please use water-soluble cutting liquid.
- 5.Down milling is recommended in the case of side milling.
- 6.Make overhang of tool as short as possible in conditions of non-interference.

AL-2B

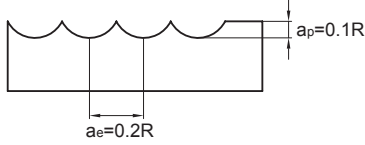
Workpiece material	Aluminum alloy		Silicon aluminum alloy Si≤10%		
	Diameter (mm)	Rotating speed (min ⁻¹)	Feed speed (mm/min)	Rotating speed (min ⁻¹)	Feed speed (mm/min)
R1.0		40000	2000	32000	1600
R1.5		26500	1950	21000	1550
R2.0		20000	1950	16000	1550
R2.5		16000	1950	13000	1550
R3.0		13000	2000	10600	1600
R4.0		10000	2450	8000	2000
R5.0		8000	2200	6500	1750
R6.0		6600	2050	5300	1650
Maximum cutting depth					

1. Please select high rigidity and precision machine and tool holder. Vibration and abnormal noise may be generated if the machine rigidity and workpiece fixture stability is low. Please reduce the rotating speed and feed speed stated above correspondingly.
2. If the cutting depth is low, it is possible to increase the rotating speed and feed speed correspondingly.
3. Please use water-soluble cutting liquid.
4. Make overhang of tool as short as possible in conditions of non-interference.

AL-3W

Workpiece material	Aluminum alloy		Silicon aluminum alloy Si≤10%	
Cutting speed	250m/min		200m/min	
Diameter (mm)	Rotating speed (min ⁻¹)	Feed speed (mm/min)	Rotating speed (min ⁻¹)	Feed speed (mm/min)
6	13000	3000	10600	1900
8	10000	3000	8000	1900
10	8000	2900	6500	1850
12	6600	2700	5300	1700
14	5700	2600	4600	1650
16	5000	2550	4000	1600
18	4400	2500	3500	1550
20	4000	2400	3200	1500

Maximum cutting depth	<p>Diagram showing side milling parameters: $a_e = 0.25D$ and $a_p = 1.5D$.</p>	<p>Diagram showing slot milling parameters: $a_e = 1D$ and $a_p = 1D$.</p>
-----------------------	---	--

1. The above table shows the reference value of side milling. The feed speed in slot milling is 70% of the reference value stated in the table, and feed rate 50%.
2. Please select high rigidity and precision machine and tool holder. Vibration and abnormal noise may be generated if the machine rigidity and workpiece fixture stability is low. Please reduce the rotating speed and feed speed stated above correspondingly.
3. It is possible to increase the rotating speed and feed speed correspondingly if the cutting depth is low.
4. Please use water-soluble cutting liquid.
5. Down milling is recommended in the case of side milling.
6. Make overhang of tool as short as possible in conditions of non-interference.

AL-2R-AIR

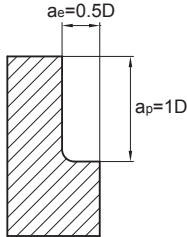
Workpiece material	Aluminum alloy		Silicon aluminum alloy Si≤10%	
Cutting speed	500~800m/min		500~800m/min	
Diameter (mm)	Rotating speed (min ⁻¹)	Feed speed (mm/min)	Rotating speed (min ⁻¹)	Feed speed (mm/min)
6	35000	3500	35000	3500
8	26000	3800	26000	3800
10	21000	4000	21000	4000
12	18000	4300	18000	4300
16	15000	4800	15000	4800
20	12000	5500	12000	5500
Maximum cutting depth				

1. Above cutting parameters are suitable for aluminium high speed machining specific CNC.
2. Please select cutting liquid or strong air cooling system for chip flowing out.
3. The sparkle by machining or heat caused by breakage might result in fire or conflagration. Please pay attention to fire prevention.
4. Dynamic balance detection should be done before machining.

AL-2RL-AIR

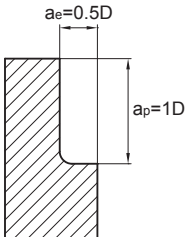
Workpiece material	Aluminum alloy		Silicon aluminum alloy Si≤10%	
Cutting speed	500~800m/min		500~800m/min	
Diameter (mm)	Rotating speed (min ⁻¹)	Feed speed (mm/min)	Rotating speed (min ⁻¹)	Feed speed (mm/min)
6	30000	3000	30000	3000
8	24000	3200	24000	3200
10	20000	3500	20000	3500
12	16000	3800	16000	3800
16	12000	4000	12000	4000
20	10000	4600	10000	4600
Maximum cutting depth				

1. Above cutting parameters are suitable for aluminium high speed machining specific CNC.
2. Please select cutting liquid or strong air cooling system for chip flowing out.
3. The sparkle by machining or heat caused by breakage might result in fire or conflagration. Please pay attention to fire prevention.
4. Dynamic balance detection should be done before machining.

Indexable milling tools

Solid carbide end mills

Cutting parameters for AL series end mills

Cutting parameters for AL series end mills

AL-3R-AIR

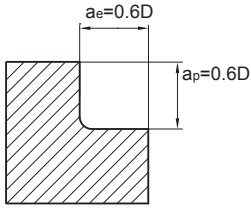
Workpiece material	Aluminum alloy		Silicon aluminum alloy Si≤10%	
Cutting speed	800~1200m/min		800~1200m/min	
Diameter (mm)	Rotating speed (min ⁻¹)	Feed speed (mm/min)	Rotating speed (min ⁻¹)	Feed speed (mm/min)
12	25000	6000	25000	6000
16	20000	6400	20000	6400
20	15000	7000	15000	7000
Maximum cutting depth				

1. Above cutting parameters are suitable for aluminium high speed machining specific CNC.
2. Please select cutting liquid or strong air cooling system for chip flowing out.
3. The sparkle by machining or heat caused by breakage might result in fire or conflagration. Please pay attention to fire prevention.
4. Dynamic balance detection should be done before machining.

AL-3RL-AIR

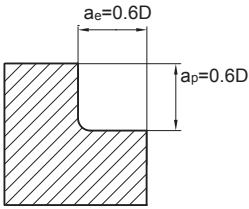
Workpiece material	Aluminum alloy		Silicon aluminum alloy Si≤10%	
Cutting speed	800~1200m/min		800~1200m/min	
Diameter (mm)	Rotating speed (min ⁻¹)	Feed speed (mm/min)	Rotating speed (min ⁻¹)	Feed speed (mm/min)
12	22000	5300	22000	5300
16	18000	5700	18000	5700
20	13000	6000	13000	6000
Maximum cutting depth				

1. Above cutting parameters are suitable for aluminium high speed machining specific CNC.
2. Please select cutting liquid or strong air cooling system for chip flowing out.
3. The sparkle by machining or heat caused by breakage might result in fire or conflagration. Please pay attention to fire prevention.
4. Dynamic balance detection should be done before machining.

ALG-2E

Workpiece material	Aluminum alloy		Silicon aluminum alloy Si≤10%		
	Diameter (mm)	Rotating speed (min ⁻¹)	Feed speed (mm/min)	Rotating speed (min ⁻¹)	Feed speed (mm/min)
1		40000	650	40000	500
2		40000	950	32000	750
3		26500	1500	21000	1100
4		20000	1600	16000	1250
5		16000	1500	13000	1100
6		13000	1250	10600	1000
8		10000	1400	8000	1100
10		8000	1600	6500	1250
12		6600	1650	5300	1300
14		5700	1700	4600	1350
16		5000	1700	4000	1350
18		4400	1700	3500	1350
20		4000	1700	3200	1350

Maximum cutting depth	
-----------------------	--

1. The above table shows the standard value of side milling. When milling slot, 70% of feed speed stated above are recommend as standard.
2. Please select high-rigidity and high-precision machine and tool holder. When the machine rigidity and workpiece fixture stability is low, vibration and abnormal noise may be generated. Please reduce the rotating speed and feed speed above correspondingly.
3. When cutting depth is smaller, rotating speed and feed speed can be increased correspondingly.
4. Please select water-soluble cutting liquid.
5. Down milling is recommended in the case of side milling.
6. Make overhang of tool as short as possible in condition of non-interference.

ALG-3E

Workpiece material	Aluminum alloy		Silicon aluminum alloy Si≤10%		
	Diameter (mm)	Rotating speed (min ⁻¹)	Feed speed (mm/min)	Rotating speed (min ⁻¹)	Feed speed (mm/min)
1		40000	800	40000	600
2		40000	1200	32000	900
3		26500	1800	21000	1300
4		20000	2000	16000	1500
5		16000	1750	13000	1300
6		13000	1500	10600	1200
8		10000	1650	8000	1300
10		8000	1900	6500	1500
12		6600	1950	5300	1550
14		5700	2000	4600	1600
16		5000	2000	4000	1600
18		4400	2000	3500	1600
20		4000	2000	3200	1600
Maximum cutting depth					

1. The above table shows the standard value of side milling. When milling slot, 70% of feed speed stated above are recommend as standard.
2. Please select high-rigidity and high-precision machine and tool holder. When the machine rigidity and workpiece fixture stability is low, vibration and abnormal noise may be generated. Please reduce the rotating speed and feed speed above correspondingly.
3. When cutting depth is smaller, rotating speed and feed speed can be increased correspondingly.
4. Please select water-soluble cutting liquid.
5. Down milling is recommended in the case of side milling.
6. Make overhang of tool as short as possible in condition of non-interference.

Indexable milling tools

Solid carbide end mills

Cutting parameters for ALG series end mills

ALG-2R

Workpiece material	Aluminum alloy		Silicon aluminum alloy Si≤10%		
	Diameter (mm)	Rotating speed (min ⁻¹)	Feed speed (mm/min)	Rotating speed (min ⁻¹)	Feed speed (mm/min)
1		40000	710	40000	550
2		40000	1040	32000	820
3		26500	1650	21000	1210
4		20000	1760	16000	1370
6		13000	1370	10600	1100
8		10000	1540	8000	1210
10		8000	1760	6500	1370
12		6600	1810	5300	1430
Maximum cutting depth					

1. The above table shows the standard value of side milling. When milling slot, 50%~70% of rotating speed and 40%~60% of feed speed stated above are recommended as standard.
2. Please select high-precision machine and tool holder.
3. Please use air blow or cutting liquid with high mist retardant property.
4. Down milling is recommended in the case of side milling.
5. When the machine rigidity and workpiece fixture stability is low, vibration and abnormal noise may be generated. Please reduce the rotating speed and feed speed stated above correspondingly.
6. Make overhang of tool as short as possible in conditions of non-interference.

ALG-3R

Workpiece material	Aluminum alloy		Silicon aluminum alloy Si≤10%		
	Diameter (mm)	Rotating speed (min ⁻¹)	Feed speed (mm/min)	Rotating speed (min ⁻¹)	Feed speed (mm/min)
1		40000	880	40000	660
2		40000	1320	32000	990
3		26500	1980	21000	1430
4		20000	2200	16000	1650
6		13000	1650	10600	1320
8		10000	1810	8000	1430
10		8000	2090	6500	1650
12		6600	2140	5300	1700
Maximum cutting depth					

Indexable milling tools

Solid carbide end mills

Cutting parameters for ALG series end mills

1. The above table shows the standard value of side milling. When milling slot, 50%~70% of rotating speed and 40%~60% of feed speed stated above are recommended as standard.
2. Please select high-precision machine and tool holder.
3. Please use air blow or cutting liquid with high mist retardant property.
4. Down milling is recommended in the case of side milling.
5. When the machine rigidity and workpiece fixture stability is low, vibration and abnormal noise may be generated. Please reduce the rotating speed and feed speed stated above correspondingly.
6. Make overhang of tool as short as possible in conditions of non-interference.

SM-3E

Workpiece material	Carbon steel, Alloy steel		Stainless steel		
	Diameter (mm)	Rotating speed (min ⁻¹)	Feed speed (mm/min)	Rotating speed (min ⁻¹)	Feed speed (mm/min)
	3	8500	660	4400	100
	4	6400	690	3700	160
	5	5800	710	3000	190
	6	5300	750	2700	200
	8	3900	700	2000	210
	10	3100	640	1600	210
	12	2600	600	1300	170
	16	1900	520	1000	130
	20	1500	445	800	140
Maximum cutting depth					

- The above table shows the standard value of side milling. When milling slot, rotating speed is around 80%~100% of the stated value, and feed speed around 60%~80%.
- Non water-soluble cutting liquid is recommended in machining of stainless steel and heat-resistant alloy.
- Please select high rigid and precise machine and tool holder.
- Adjust rotating speed and feed speed according to cutting depth and machine rigidity.
- Down milling is recommended in the case of side milling.
- Make overhang of tool as short as possible in conditions of non-interference.

VSM-4E★VSM-4EFP

Workpiece material	Carbon steel, Alloy steel		Stainless steel		Heat resistant alloy, Titanium alloy	
	Diameter (mm)	Rotating speed (min ⁻¹)	Feed speed (mm/min)	Rotating speed (min ⁻¹)	Feed speed (mm/min)	Rotating speed (min ⁻¹)
4	6400	690	3700	160	3055	90
5	5800	710	3000	190	2470	90
6	5300	750	2700	200	2470	120
8	3900	700	2000	210	1820	130
10	3100	640	1600	210	1430	130
12	2600	600	1300	170	1235	110
16	1900	520	1000	150	935	90
20	1500	445	800	140	740	90

Maximum cutting depth	Carbon steel, Alloy steel		Stainless steel		Heat resistant alloy, Titanium alloy	
	Diagram	Diagram	Diagram	Diagram	Diagram	Diagram

1. The above table shows the standard value of side milling. When milling slot, rotating speed is around 80%~100% of the stated value, and feed speed around 60%~80%.
2. Non water-soluble cutting liquid is recommended in machining of stainless steel and heat-resistant alloy.
3. Please select high rigid and precise machine and tool holder.
4. Adjust rotating speed and feed speed according to cutting depth and machine rigidity.
5. Down milling is recommended
6. Make overhang of tool as short as possible in condition of non-interference.
7. The above table is recommended data based on $L/D \leq 4$. When $L/D > 4$, please reduce 70% of rotating speed and feed speed correspondingly.

Indexable milling tools

Solid carbide end mills

Cutting parameters for SM/VSM series end mills

SM-4R

Workpiece material	Carbon steel、Alloy steel		Stainless steel	
	Diameter (mm)	Rotating speed (min^{-1})	Feed speed (mm/min)	Rotating speed (min^{-1})
6	5300	900	2700	240
8	3900	840	2000	255
10	3100	770	1600	255
12	2600	720	1300	205
Maximum cutting depth				

- The above table shows the standard value of side milling. When milling slot, rotating speed is around 80%~100% of the stated value, and feed speed around 60%~80%.
- Non water-soluble cutting liquid is recommended in machining of stainless steel and heat-resistant alloy.
- Please select high rigid and precise machine and tool holder.
- Adjust rotating speed and feed speed according to cutting depth and machine rigidity.
- Down milling is recommended in the case of side milling.
- Make overhang of tool as short as possible in conditions of non-interference.

VSM-4R★VSM-4RFP

Workpiece material	Carbon steel、Alloy steel		Stainless steel		Heat resistant alloy、Titanium alloy	
	Diameter (mm)	Rotating speed (min ⁻¹)	Feed speed (mm/min)	Rotating speed (min ⁻¹)	Feed speed (mm/min)	Rotating speed (min ⁻¹)
6	5300	900	2700	240	2470	145
8	3900	840	2000	255	1820	155
10	3100	770	1600	255	1430	155
12	2600	720	1300	205	1235	135
16	1900	625	1000	180	935	110

Maximum cutting depth		
-----------------------	--	--

1. The above table shows the standard value of side milling. When milling slot, rotating speed is around 80%~100% of the stated value, and feed speed around 60%~80%.
2. Non water-soluble cutting liquid is recommended in machining of stainless steel and heat-resistant alloy.
3. Please select high rigid and precise machine and tool holder.
4. Adjust rotating speed and feed speed according to cutting depth and machine rigidity.
5. Down milling is recommended
6. Make overhang of tool as short as possible in condition of non-interference.
7. The above table is recommended data based on $L/D \leq 4$. When $L/D > 4$, please reduce 70% of rotating speed and feed speed correspondingly.

Indexable milling tools

Solid carbide end mills

Cutting parameters for SM/VSM series end mills

CM-2E

Workpiece material	Cast iron, Nodular cast iron		Carbon steel, Alloy steel		Pre-hardened steel		Stainless steel		Heat resistant alloy, Titanium alloy		Aluminum alloy	
	Rotating speed (min ⁻¹)	Feed (mm/r)	Rotating speed (min ⁻¹)	Feed (mm/r)	Rotating speed (min ⁻¹)	Feed (mm/r)	Rotating speed (min ⁻¹)	Feed (mm/r)	Rotating speed (min ⁻¹)	Feed (mm/r)	Rotating speed (min ⁻¹)	Feed (mm/r)
3	14000	0.017	14000	0.016	13000	0.017	7500	0.016	5308	0.016	20000	0.055
4	10800	0.02	10800	0.02	10000	0.02	5500	0.02	3980	0.02	15000	0.066
6	7000	0.024	7000	0.024	6400	0.024	3700	0.024	2654	0.024	10000	0.075
8	5200	0.03	5200	0.03	4800	0.03	2800	0.03	1990	0.03	8000	0.08
10	4200	0.05	4200	0.05	3800	0.05	2200	0.05	1592	0.05	6500	0.12
12	3500	0.065	3500	0.065	3200	0.065	1850	0.065	1326	0.06	5500	0.14
16	2600	0.09	2600	0.09	2400	0.09	1400	0.09	955	0.08	3180	0.16

1. Please select high-precision machine and tool holder.
2. Please use air blow or cutting liquid with high mist retardant property.
3. Make overhang of tool as short as possible in conditions of non-interference.
4. Reduce feed speed correspondingly when rotating speed is low.



CM-4E

Workpiece material	Cast iron, Nodular cast iron		Carbon steel, Alloy steel		Pre-hardened steel		Stainless steel		Heat resistant alloy, Titanium alloy		Aluminum alloy	
	Rotating speed (min ⁻¹)	Feed (mm/r)	Rotating speed (min ⁻¹)	Feed (mm/r)	Rotating speed (min ⁻¹)	Feed (mm/r)	Rotating speed (min ⁻¹)	Feed (mm/r)	Rotating speed (min ⁻¹)	Feed (mm/r)	Rotating speed (min ⁻¹)	Feed (mm/r)
3	12700	0.032	14000	0.032	13000	0.034	7500	0.024	5308	0.024	10600	0.025
4	9550	0.04	10800	0.04	10000	0.04	5500	0.032	3980	0.032	6500	0.037
6	6370	0.048	7000	0.048	6400	0.048	3700	0.04	2654	0.04	5300	0.07
8	4770	0.06	5200	0.06	4800	0.06	2800	0.048	1990	0.048	4000	0.11
10	3820	0.10	4200	0.10	3800	0.10	2200	0.06	1592	0.06	3500	0.125
12	3180	0.128	3500	0.128	3200	0.125	1850	0.10	1326	0.10	3000	0.15
16	2380	0.164	2600	0.164	2400	0.16	1400	0.125	955	0.125	2200	0.18

1. Please select high-precision machine and tool holder.
2. Please use air blow or cutting liquid with high mist retardant property.
3. Make overhang of tool as short as possible in conditions of non-interference.
4. Reduce feed speed correspondingly when rotating speed is low.

Indexable milling tools

Solid carbide end mills

Cutting parameters for CM series end mills

Parts terminology of end mill

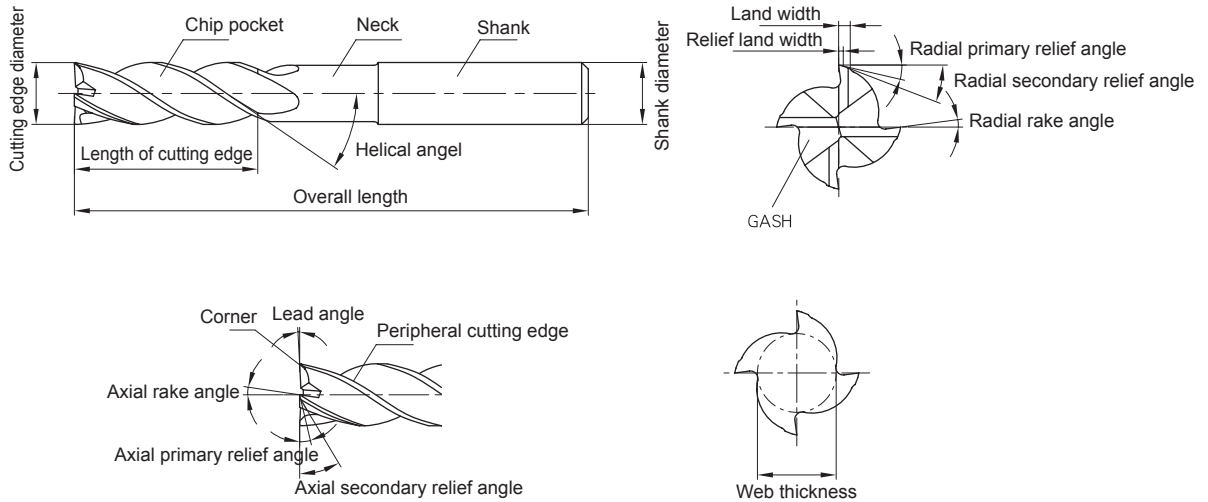

Number of teeth, chip pocket and tool rigidity

Number of teeth		2 Flutes	3 Flutes	4 Flutes
Profile of cross section				
Proportion of cross section		54%	56%	60%
Features	Advantages	<ul style="list-style-type: none"> ● Large chip pocket ● Easy chip removal 	<ul style="list-style-type: none"> ● Easy chip removal ● Perfect surface finish 	<ul style="list-style-type: none"> ● Good rigidity ● Perfect surface finish
	Disadvantages	Low rigidity	Difficult to measure external diameter	Chip removal is not smooth
Functions		<ol style="list-style-type: none"> 1. Slot machining 2. Side face machining 3. Hole machining 	<ol style="list-style-type: none"> 1. Slot machining 2. Side face machining 3. Heavy cutting 4. For finishing 	<ol style="list-style-type: none"> 1. Shallow slot machining 2. Side face machining 3. For finishing

Indexable milling tools

Solid carbide end mills

Technical information

Down milling and up milling

Side milling

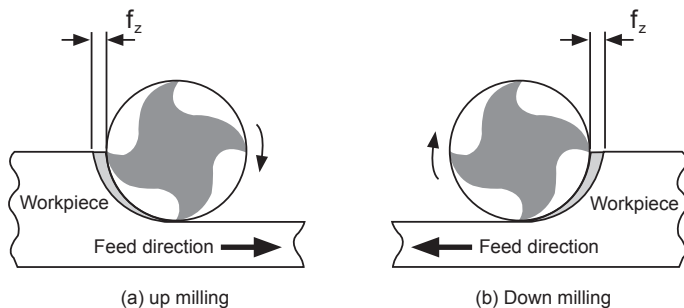

Slot milling

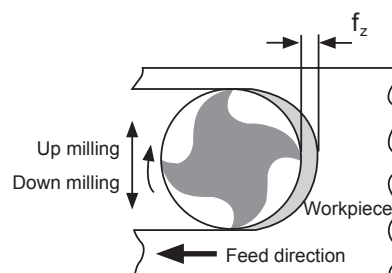

Length of cutting edge (overhang) and cutting edge diameter

The shorter of overhang is, the higher the rigidity is. Thus it is not easy to bend or vibrate in the cutting process, and machining precision is improved. When length of cutting edge (overhang) doubles, the Deflection degree (f) will be 8 times of the original.

When the overhang is reduced by 20%, the Deflection degree (f) will decrease by 50%.
When the diameter increases by 20%, the Deflection degree (f) will decrease by 50%.

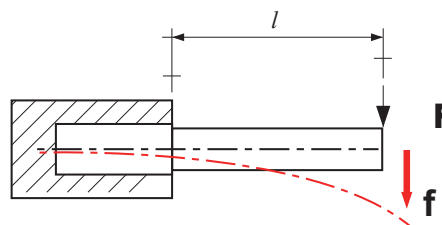

$$f = \frac{F \cdot l^3}{3 \cdot E \cdot I} = \frac{F \cdot l^3 \cdot 64}{3 \cdot E \cdot d^4 \cdot \pi}$$

Feed rate selection table in profile machining by ball nose and R end mills

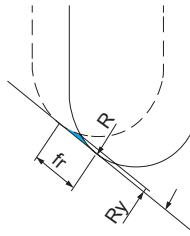

$$Ry = R \times \{1 - \cos[\arcsin(fr/2R)]\}$$

Ry: Theoretical value of surface roughness

fr: Feed rate

R: Ball nose radius or corner radius

Table of theoretical roughness formed by ball nose of end mill (corner radius of R end mill) and feed rate(mm)

R	Ry	Feed rate fr									
		0.1	0.2	0.3	0.4	0.5	0.6	0.7	0.8	0.9	1.0
0.5		0.003	0.010	0.023	0.042	0.067	0.100				
1.0		0.001	0.005	0.011	0.020	0.032	0.046	0.063	0.083	0.107	
1.5		0.001	0.003	0.008	0.013	0.021	0.030	0.041	0.054	0.069	0.086
2.0		0.001	0.003	0.006	0.010	0.015	0.023	0.031	0.040	0.051	0.064
2.5		0.001	0.002	0.005	0.008	0.013	0.018	0.025	0.032	0.041	0.051
3.0			0.001	0.004	0.007	0.010	0.015	0.020	0.027	0.034	0.042
4.0			0.001	0.003	0.005	0.008	0.011	0.015	0.020	0.025	0.031
5.0			0.001	0.002	0.004	0.006	0.009	0.012	0.016	0.020	0.025
6.0				0.002	0.003	0.005	0.008	0.010	0.013	0.017	0.021
8.0				0.001	0.003	0.004	0.006	0.008	0.010	0.013	0.016
10.0				0.001	0.002	0.003	0.005	0.006	0.008	0.010	0.013
12.5				0.001	0.002	0.003	0.004	0.005	0.006	0.008	0.010

R	Ry	Feed rate fr									
		1.1	1.2	1.3	1.4	1.5	1.6	1.7	1.8	1.9	2.0
0.5											
1.0											
1.5		0.104									
2.0		0.077	0.092	0.109							
2.5		0.061	0.073	0.086	0.100						
3.0		0.051	0.061	0.071	0.083	0.095	0.109				
4.0		0.038	0.045	0.053	0.062	0.071	0.081	0.091	0.103		
5.0		0.030	0.036	0.042	0.049	0.057	0.064	0.073	0.082	0.091	0.101
6.0		0.025	0.030	0.035	0.041	0.047	0.054	0.061	0.068	0.076	0.084
8.0		0.019	0.023	0.026	0.031	0.035	0.040	0.045	0.051	0.057	0.063
10.0		0.015	0.018	0.021	0.025	0.028	0.032	0.036	0.041	0.045	0.050
12.5		0.012	0.014	0.017	0.020	0.023	0.026	0.029	0.032	0.036	0.040

Indexable milling tools

Solid carbide end mills

Technical information

Cutting parameters calculation

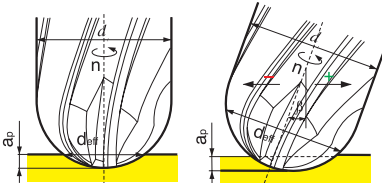
Symbol	Description	Formula
n	Rotating speed per minute $n[\text{min}^{-1}]/\text{r}/\text{min}$	$n = \frac{v_c \cdot 1000}{d \cdot \pi}$
v_c	Cutting speed $V_c[\text{m}/\text{min}]$	$v_c = \frac{d \cdot \pi \cdot n}{1000}$
f_z	Amount of feed per tooth $f_z[\text{mm}/\text{tooth}]$	$f_z = \frac{V_f}{z \cdot n}$
f	Amount of feed per rotation $f_z[\text{mm}/\text{rev.}]$	$f = f_z \cdot z$
V_f	Feed rate $V_f[\text{mm}/\text{min}]$	$V_f = f_z \cdot z \cdot n = f \cdot n$
Q	Removal rate $Q[\text{cm}^3/\text{min}]$	$Q = \frac{a_e \cdot a_p \cdot v_f}{1000}$
d_{eff}	Effective diameter of ball nose end mill $d_{\text{eff}}[\text{mm}]$ 	$\beta = 0$ $d_{\text{eff}} = 2 \cdot \sqrt{d \cdot a_p - a_p^2}$ $\beta \neq 0$ $d_{\text{eff}} = d \cdot \sin[\beta \pm \arccos(\frac{d - 2a_p}{d})]$
V_{eff}	Effective cutting speed of end mill $V_{\text{eff}}[\text{m}/\text{min}]$	$V_{\text{eff}} = \frac{d_{\text{eff}} \cdot \pi \cdot n}{1000}$
a_e	Radial cutting width $a_e[\text{mm}]$	
a_p	Axial cutting depth $a_p[\text{mm}]$	
d	Milling diameter $d[\text{mm}]$	
z	Number of teeth	
β	Inclined angle	

Common problems and solutions for end mill

Solutions Common problems		Tool material	Cutting condition						Tool shape			Machine clamping					
			Select coated end mill	Cutting speed	Feed rate	Cutting depth	Cutting direction (down / up milling)	Cutting liquid			Helical angle	Number of tooth	Milling diameter	Reduce the overhang length	Improve tool clamping precision	Change collet	Increase clamping force
Increase the amount of cutting liquid	Water-insoluble cutting liquid	Dry or wet machining															
Tool fracture	Fracture of end mill			↓	↓						↓	↑	✓		✓	✓	
Damage of cutting edge	Rapid wear of cutting edge	✓	↓	↑		down		✓				↑					
	Breakage		↓	↓	↓	down			dry			✓		✓			✓
	Severe chips bond	✓						✓	wet	↑							
Machining precision	Poor surface quality		↑	↓	↓			✓	wet					✓			
	Uneven			↓	↓					↓	↑	↑		✓	✓		
	Uneven side face of workpiece			↓	↓	up		✓		↑	↑	↑	✓				
	Burrs, breakage and slice frittering			↓	↓					↓							
	Large vibration		↓	↑						↑	↓	↑	✓		✓	✓	✓
Chip control	obstructed chip removal			↓	↓		✓				↓						
Others		1.Large abrasion of cutting edge is easy to cause fracture of end mill or poor surface quality, so it is recommended to regrind the end mills. 2.Make overhang of tool as short as possible.															

Indexable milling tools

Solid carbide end mills

Technical information

Customization based on standard items

Customer name:

Fax:

Tel:

E-MAIL:



Huanghe south road, Tianyuan Zone,
Zhuzhou, Hunan, P.R.China

Fax: 0731-22882721 22885420 22887878

Post code: 412007 E-Mail: zccct@zccct.com

When the diameter specification or length specification on the catalogue cannot meet your requirements, we provide more professional and more accurate non-standard customization, you just need to choose the series the customization based on.

End mill series selection

VPM series	
UM series	
PML series	
PM series	
GM series	
HMX series	
TM series	
NM series	
AL/ALG series	
SM/VSM series	
CM series	

Diameter specification	Ø0.3~20.0mm
Number of teeth	

Selection of end mill types

<input type="checkbox"/> Flattened end mill	<input type="checkbox"/> Ball nose end mill	<input type="checkbox"/> R end mill

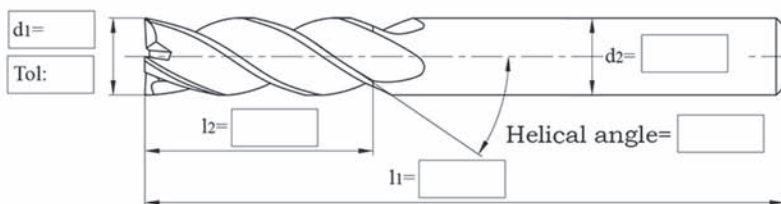

Remark/Note:

Ordering quantities: pieces

Expecting delivery date:

Quotation of supplier:

Buyer confirmation:

Date:

Indexable milling tools

Solid carbide end mills

Customization based on standard items

Customer name:	 Huanghe south road, Tianyuan Zone, Zhuzhou, Hunan,P.R.China Fax: 0731-22882721 22885420 22887878 Post code: 412007 E-Mail:zccct@zccct.com
Fax:	
Tel:	
E-MAIL:	





Workpiece material information

<input type="checkbox"/> Carbon steel <input type="checkbox"/> Alloy steel <input type="checkbox"/> Pre-hardened steel <input type="checkbox"/> Hardened steel <input type="checkbox"/> Stainless steel	<input type="checkbox"/> Grey cast iron <input type="checkbox"/> Nodular cast iron <input type="checkbox"/> Copper alloy <input type="checkbox"/> Aluminum alloy <input type="checkbox"/> Titanium alloy <input type="checkbox"/> Heat-resistant alloy	Workpiece material grade: <input type="text"/> Tensile strength= <input type="text"/> N/mm ² Hardness= <input type="text"/> Unit: (HRC,HB etc)
---	---	---

Diameter specification	Ø0.2~25.0mm	
Number of teeth	<input type="text"/>	
Cutting edge cross the center of the end mill	<input type="checkbox"/> Yes	<input type="checkbox"/> No

End mill information

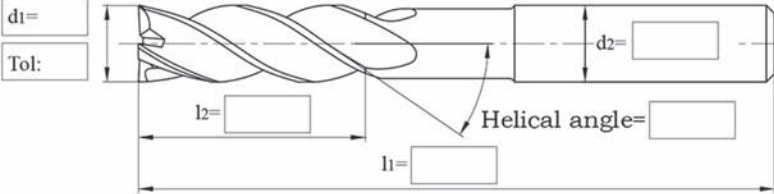

Selection of end mill types

			
<input type="checkbox"/> Flattened end mill with sharp edge	<input type="checkbox"/> Flattened end mill with corner protection edge	<input type="checkbox"/> Ball nose end mill	<input type="checkbox"/> R end mill



DIN6535	Shank type
	<input type="checkbox"/> Form HA <input type="checkbox"/> Form HB <input type="checkbox"/> Straight shank
	Special design

Machining method

		
<input type="checkbox"/> Slot milling	<input type="checkbox"/> Side milling	<input type="checkbox"/> Profiling

Coating
Yes <input type="checkbox"/>
No <input type="checkbox"/>

Remark/Note:

Ordering quantities: pieces Expecting delivery date:

Quotation of supplier: Buyer confirmation:

Date:

Indexable milling tools
 Solid carbide end mills
 Customized non-standard order

Interchangeable modular endmills series

New series of interchangeable modular endmills combines the advantages of both solid carbide endmills and indexable toolholders together to achieve high-precision, high-rigidity, and high-efficiency machining.

- Solid carbide cutting head with high precision and consistency ;
- The self-centering screw thread ensures the quick replacement, high security and high strength ;
- Double positioning from both radial and axial direction guarantees the high rigidity, high stability and high-precision coupling ;
- Quick mounting on the machine tool would reduce the non-cutting time which would increase the productivity significantly ;
- Three cutting head series could share the shanks with the indexable inserts type interchangeable series which could satisfy face milling, slot milling, shoulder milling, profile milling, ramping and plunging from roughing to finishing different working conditions.

Interchangeable milling cutter

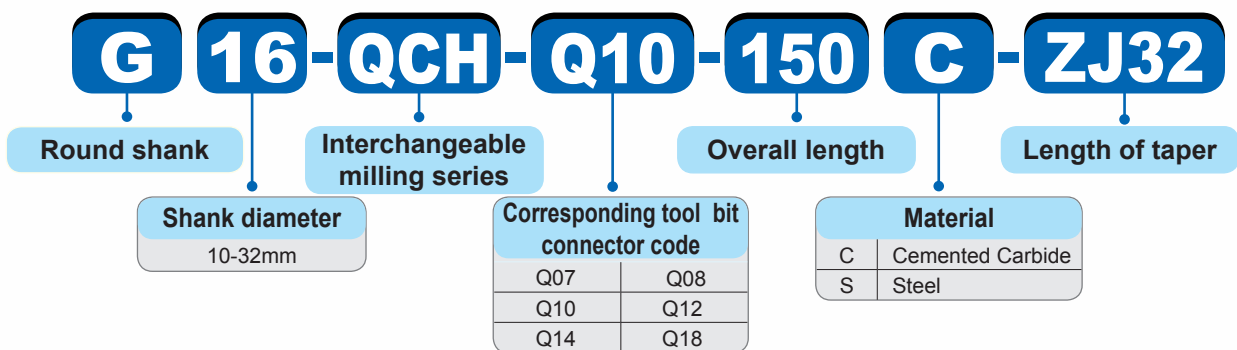

Interchangeable milling cutter

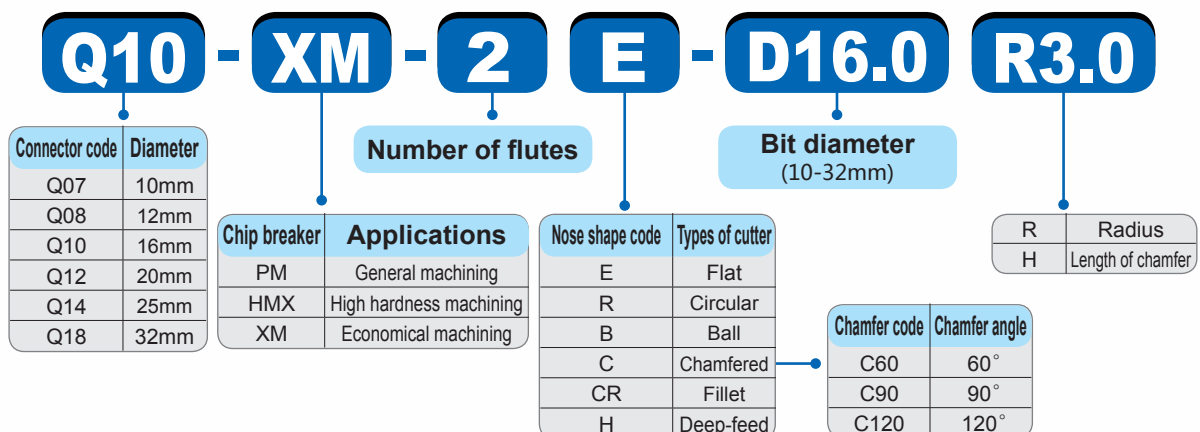

Tungsten carbide interchangeable cutting heads

Flattened endmills, Ball endmills, Radius endmills

Interchangeable shank

Selections of steel shank, carbide shank, and tooling system are suitable for long overhang, high feed rate and other working conditions.

Screw thread

The screw thread with abundant surface contact at the curved surface with high precision which provides the outstanding precision performance and stability.

High-precision positioning surface

Assurance of the perfect combination of the shank and cutting heads.

Good rigidity, longer tool life

Workpiece material : NAK80(HRC40)
 Machining methods : Profile milling
 Interchangeable head : Q10-PM-2B-D16.0
 Toolholder : G16-QCH-Q10-150C
 Cutting method: Down milling, wet cut
 Machining requirement: $Ra \leq 0.6\mu\text{m}$,
 When $Ra > 0.6\mu\text{m}$ tool failure.
 Machine tool: Vertical Machining Center
 Cutting parameters : $V_c=250\text{m/min}$, $f_z=0.06\text{mm/z}$,
 $a_p=0.5\text{mm}$, $a_e=0.5\text{mm}$

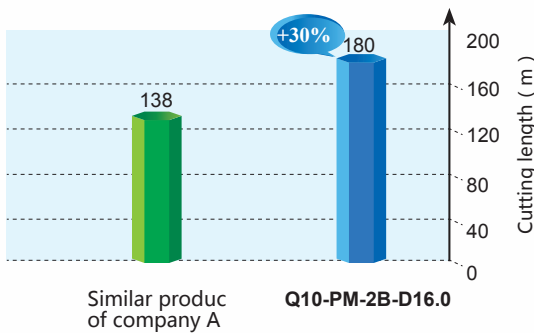

Result: The interchangeable modular endmills has good rigidity and anti-vibration performance. Comparing with the similar product from company A, it has longer tool life and better efficiency.

High-precision and extraordinary surface quality

Workpiece material : 718H(HRC35)
 Machining methods : Side milling
 Interchangeable head : Q10-PM-4E-D16.0
 Toolholder : G16-QCH-Q10-120C
 Cutting method: Down milling, wet cut
 Machine tool: Vertical Machining Center
 Cutting parameters : $V_c=200\text{m/min}$, $f_z=0.06\text{mm/z}$,
 $a_p=8\text{mm}$, $a_e=0.4\text{mm}$

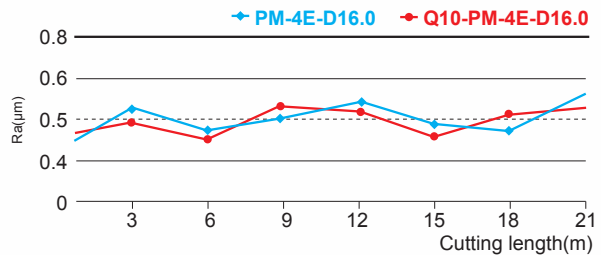
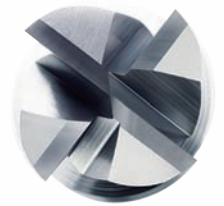

New series of interchangeable modular endmills with high precision and surface quality which has almost the same performance as the solid carbide endmills.

4-flute unequal pitch flattened end mill with straight shank



PM-4E

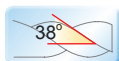
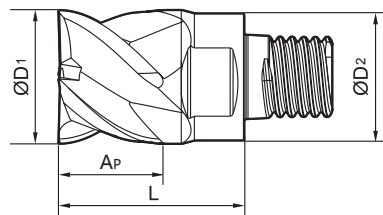
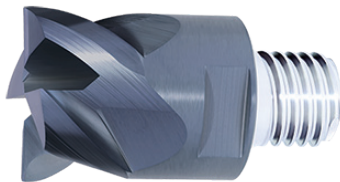

D	D ₁ ≤ 12	0-0.020
	D ₁ > 12	0-0.030



Type	Basic dimension(mm)				Interface	Number of teeth Z	Chamfering angle	Helical angle
	ØD ₁	ØD ₂	L	Ap				
Q07-PM-4E-D10.0	10	9.5	16.0	6.5	Q07	4	0.06 × 45°	38°
Q08-PM-4E-D12.0	12	11.5	17.0	7.0	Q08	4	0.10 × 45°	38°
Q10-PM-4E-D16.0	16	15.2	21.5	9.0	Q10	4	0.10 × 45°	38°
Q12-PM-4E-D20.0	20	19.0	25.5	11.0	Q12	4	0.15 × 45°	38°
Q14-PM-4E-D25.0	25	24.0	31.5	13.5	Q14	4	0.15 × 45°	38°
Q18-PM-4E-D32.0	32	30.0	36.0	17.0	Q18	4	0.15 × 45°	38°

Explain

1. Different ap, pitch, radius from the above table can be customized ;
2. When Ap less or equal to the above dimensions will have higher cost performance.

Indexable milling tools

Solid carbide end mills

PM series Interchangeable modular endmills

Applicable workpiece material table ○Very suitable ○Suitable

Workpiece material											
Carbon steel	Alloy steel	Pre-hardened steel, Hardened steel				Stainless steel	Cast iron, Nodular cast iron	Copper alloy	Aluminum alloy	Titanium alloy	Heat resistant alloy
		~40HRC	~50HRC	~55HRC	~68HRC						
○	○	○	○	○		○	○			○	○

The corresponding toolholder B586-B589

Code key B572

Graphics category and identification B259

Cutting parameters B590

2/4-flute ball nose end mills with straight shank



PM-2B/4B

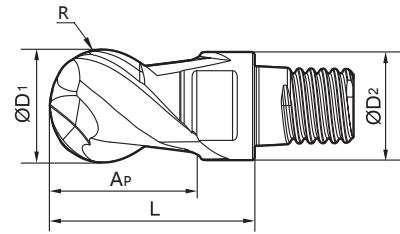

38° 30° **NGN TAIN**

D	D ₁ ≤ 12	0-0.020
	D ₁ > 12	0-0.030

R	D ₁ ≤ 20	±0.010
	D ₁ > 20	±0.020

Type	Basic dimension(mm)					Interface	Number of teeth Z	Helical angle
	ØD ₁	ØD ₂	L	Ap	R			
Q07-PM-2B-D10.0	10	9.5	16	6	5.0	Q07	2	38°
Q07-PM-4B-D10.0	10	9.5	16	6.5	5.0		4	30°
Q08-PM-2B-D12.0	12	11.5	17.0	7.0	6.0	Q08	2	38°
Q08-PM-4B-D12.0	12	11.5	17.0	7.0	6.0		4	30°
Q10-PM-2B-D16.0	16	15.2	21.5	9.0	8.0	Q10	2	38°
Q10-PM-4B-D16.0	16	15.2	21.5	9.0	8.0		4	30°
Q12-PM-2B-D20.0	20	19.0	25.5	11.0	10.0	Q12	2	38°
Q12-PM-4B-D20.0	20	19.0	25.5	11.0	10.0		4	30°
Q14-PM-2B-D25.0	25	24.0	31.5	13.5	12.5	Q14	2	38°
Q14-PM-4B-D25.0	25	24.0	31.5	13.5	12.5		4	30°
Q18-PM-2B-D32.0	32	30.0	36.0	17.0	16.0	Q18	2	38°
Q18-PM-4B-D32.0	32	30.0	36.0	17.0	16.0		4	30°

Explain

1. Different ap, pitch, radius from the above table can be customized ;
2. When Ap less or equal to the above dimensions will have higher cost performance.

Applicable workpiece material table ○Very suitable ○Suitable

Workpiece material											
Carbon steel	Alloy steel	Pre-hardened steel, Hardened steel				Stainless steel	Cast iron, Nodular cast iron	Copper alloy	Aluminum alloy	Titanium alloy	Heat resistant alloy
		~40HRC	~50HRC	~55HRC	~68HRC						
○	○	○	○	○		○	○			○	

The corresponding toolholder B586-B589 Code key B572 Graphics category and identification B259 Cutting parameters B590

Indexable milling tools
Solid carbide end mills
PM series Interchangeable modular endmills

4-flute R end mills with straight shank



PM-4R

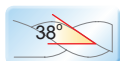
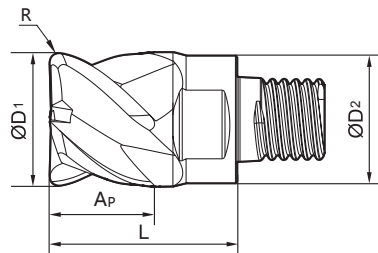

D	D ₁ < 12	0-0.020
	D ₁ > 12	0-0.030



Type	Basic dimension(mm)					Interface	Number of teeth Z	Helical angle
	ØD ₁	ØD ₂	L	Ap	R			
Q07-PM-4R-D12.0R0.5	10	9.5	16.0	6.5	0.5	Q07	4	38°
Q08-PM-4R-D12.0R1.0	12	11.5	17.0	7.0	1.0	Q08	4	38°
Q10-PM-4R-D16.0R1.5	16	15.2	21.5	9.0	1.5	Q10	4	38°
Q12-PM-4R-D20.0R2.0	20	19.0	25.5	11.0	2.0	Q12	4	38°
Q14-PM-4R-D25.0R2.5	25	24.0	31.5	13.5	2.5	Q14	4	38°
Q18-PM-4R-D32.0R3.0	32	30.0	36.0	17.0	3.0	Q18	4	38°

Explain

1. Different ap, pitch, radius from the above table can be customized ;
2. When Ap less or equal to the above dimensions will have higher cost performance.

Indexable milling tools

Solid carbide end mills

PM series Interchangeable modular endmills

Applicable workpiece material table ●Very suitable ○Suitable

Workpiece material											
Carbon steel	Alloy steel	Pre-hardened steel, Hardened steel				Stainless steel	Cast iron, Nodular cast iron	Copper alloy	Aluminum alloy	Titanium alloy	Heat resistant alloy
		~40HRC	~50HRC	~55HRC	~68HRC						
●	●	●	●	●		○	●			○	○

The corresponding toolholder B586-B589

Code key B572

Graphics category and identification B259

Cutting parameters B590

HMX series Interchangeable modular endmills

4-flute unequal pitch flattened end mill with straight shank



HMX-4E

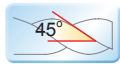
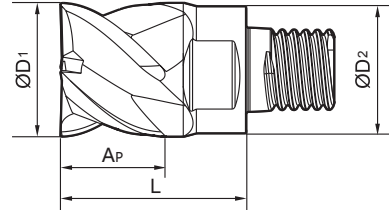
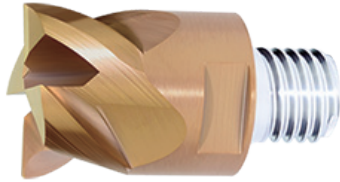

D	D ₁ ≤ 12	0-0.020
	D ₁ > 12	0-0.030



Type	Basic dimension(mm)				Interface	Number of teeth Z	Chamfering angle	Helical angle
	ØD ₁	ØD ₂	L	Ap				
Q07-HMX-4E-D12.0	10	9.5	16.0	6.5	Q07	4	0.06 × 45°	45°
Q08-HMX-4E-D12.0	12	11.5	17.0	7.0	Q08	4	0.1 × 45°	45°
Q10-HMX-4E-D16.0	16	15.2	21.5	9.0	Q10	4	0.1 × 45°	45°
Q12-HMX-4E-D20.0	20	19.0	25.5	11.0	Q12	4	0.15 × 45°	45°
Q14-HMX-4E-D25.0	25	24.0	31.5	13.5	Q14	4	0.15 × 45°	45°
Q18-HMX-4E-D32.0	32	30.0	36.0	17.0	Q18	4	0.15 × 45°	45°

Explain

1. Different ap, pitch, radius from the above table can be customized ;
2. When Ap less or equal to the above dimensions will have higher cost performance.

Indexable milling tools
Solid carbide end mills

HMX series Interchangeable modular endmills

Applicable workpiece material table ●Very suitable ○Suitable

Workpiece material											
Carbon steel	Alloy steel	Pre-hardened steel, Hardened steel				Stainless steel	Cast iron, Nodular cast iron	Copper alloy	Aluminum alloy	Titanium alloy	Heat resistant alloy
		~40HRC	~50HRC	~55HRC	~68HRC						
			○	●	●		○				



2/4-flute ball nose end mills with straight shank



HMX-2B/4B

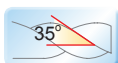
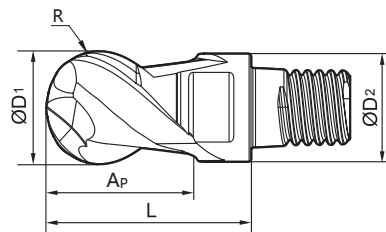

D	D ₁ ≤ 12	0-0.020
	D ₁ > 12	0-0.030

R	D ₁ ≤ 20	±0.010
	D ₁ > 20	±0.020



Type	Basic dimension(mm)					Interface	Number of teeth Z	Helical angle
	ØD ₁	ØD ₂	L	Ap	R			
Q07-HMX-2B-D10.0	10	9.5	16	6.0	5.0	Q07	2	35°
Q07-HMX-4B-D10.0	10	9.5	16	6.5	5.0		4	35°
Q08-HMX-2B-D12.0	12	11.5	17.0	7.0	6.0	Q08	2	35°
Q08-HMX-4B-D12.0	12	11.5	17.0	7.0	6.0		4	35°
Q10-HMX-2B-D16.0	16	15.2	21.5	9.0	8.0	Q10	2	35°
Q10-HMX-4B-D16.0	16	15.2	21.5	9.0	8.0		4	35°
Q12-HMX-2B-D20.0	20	19.0	25.5	11.0	10.0	Q12	2	35°
Q12-HMX-4B-D20.0	20	19.0	25.5	11.0	10.0		4	35°
Q14-HMX-2B-D25.0	25	24.0	31.5	13.5	12.5	Q14	2	35°
Q14-HMX-4B-D25.0	25	24.0	31.5	13.5	12.5		4	35°
Q18-HMX-2B-D32.0	32	30.0	36.0	17.0	16.0	Q18	2	35°
Q18-HMX-4B-D32.0	32	30.0	36.0	17.0	16.0		4	35°

Explain

1. Different ap, pitch, radius from the above table can be customized ;
2. When Ap less or equal to the above dimensions will have higher cost performance.

Applicable workpiece material table ●Very suitable ○Suitable

Workpiece material											
Carbon steel	Alloy steel	Pre-hardened steel, Hardened steel				Stainless steel	Cast iron, Nodular cast iron	Copper alloy	Aluminum alloy	Titanium alloy	Heat resistant alloy
		~40HRC	~50HRC	~55HRC	~68HRC						
			○	●	●		○				

The corresponding toolholder B586-B589

Code key B572

Graphics category and identification B259

Cutting parameters B590

HMX series Interchangeable modular endmills

4-flute R end mills with straight shank



HMX-4R

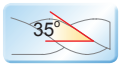
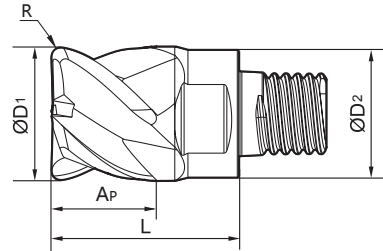
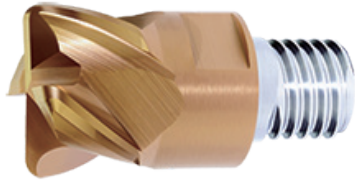

D	D ₁ ≤ 12	0-0.020
	D ₁ > 12	0-0.030



Type	Basic dimension(mm)					Interface	Number of teeth Z	Helical angle
	ØD ₁	ØD ₂	L	Ap	R			
Q07-HMX-4R-D12.0R0.5	10	9.5	16.0	6.5	0.5	Q07	4	35°
Q08-HMX-4R-D12.0R1.0	12	11.5	17.0	7.0	1.0	Q08	4	35°
Q10-HMX-4R-D16.0R1.5	16	15.2	21.5	9.0	1.5	Q10	4	35°
Q12-HMX-4R-D20.0R2.0	20	19.0	25.5	11.0	2.0	Q12	4	35°
Q14-HMX-4R-D25.0R2.5	25	24.0	31.5	13.5	2.5	Q14	4	35°
Q18-HMX-4R-D32.0R3.0	32	30.0	36.0	17.0	3.0	Q18	4	35°

Explain

1. Different ap, pitch, radius from the above table can be customized ;
2. When Ap less or equal to the above dimensions will have higher cost performance.

Applicable workpiece material table ●Very suitable ○Suitable

Workpiece material											
Carbon steel	Alloy steel	Pre-hardened steel, Hardened steel				Stainless steel	Cast iron, Nodular cast iron	Copper alloy	Aluminum alloy	Titanium alloy	Heat resistant alloy
		~40HRC	~50HRC	~55HRC	~68HRC						
			○	●	●		○				



Indexable milling tools

Solid carbide end mills

HMX series Interchangeable modular endmills

XM series Interchangeable modular endmills

XM series of interchangeable flat endmill



XM-2E

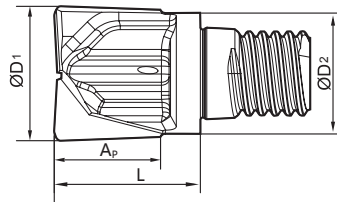

Coated
**NANO
TiAlN**

D	D ₁ ≤ 12	0-0.020
	D ₁ > 12	0-0.030



Type	Basic dimension(mm)				Interface	Number of teeth Z	Stock
	ØD ₁	ØD ₂	L	Ap			
Q07-XM-2E-D10.0	10	9.5	12.5	9	Q07	2	●
Q08-XM-2E-D12.0	12	11.5	15.3	10	Q08	2	●
Q10-XM-2E-D16.0	16	15.2	18.0	14	Q10	2	●

● Stock available ○ Make-to-order

Indexable
milling tools

Solid carbide
end mills

XM series Interchangeable modular endmills

Applicable workpiece material table ●Very suitable ○Suitable

Workpiece material											
Carbon steel	Alloy steel	Pre-hardened steel, Hardened steel				Stainless steel	Cast iron, Nodular cast iron	Copper alloy	Aluminum alloy	Titanium alloy	Heat resistant alloy
		~40HRC	~50HRC	~55HRC	~68HRC						
●	●	●	●	●		○	●			○	

The corresponding toolholder B586-B589

Code key B572

Graphics category and identification B259

Cutting parameters B591

XM series Interchangeable modular endmills

XM series of interchangeable R endmill



XM-2R

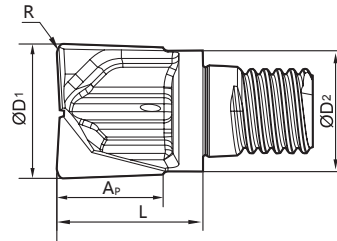

D	D ₁ ≤ 12	0-0.020
	D ₁ > 12	0-0.030



Type	Basic dimension(mm)					Interface	Number of teeth Z	Stock
	ØD ₁	ØD ₂	L	Ap	R			
Q07-XM-2R-D10.0R1.0	10	9.5	11.0	6	1.0	Q07	2	●
Q07-XM-2R-D10.0R2.0	10	9.5	11.0	6	2.0	Q07	2	●
Q08-XM-2R-D12.0R1.0	12	11.5	11.0	6	1.0	Q08	2	●
Q08-XM-2R-D12.0R2.0	12	11.5	11.0	6	2.0	Q08	2	●
Q08-XM-2R-D12.0R3.0	12	11.5	11.0	6	3.0	Q08	2	●
Q10-XM-2R-D16.0R1.0	16	15.2	13.5	7	1.0	Q10	2	●
Q10-XM-2R-D16.0R2.0	16	15.2	13.5	7	2.0	Q10	2	●
Q10-XM-2R-D16.0R3.0	16	15.2	13.5	7	3.0	Q10	2	●
Q10-XM-2R-D16.0R4.0	16	15.2	13.5	7	4.0	Q10	2	●

● Stock available ○ Make-to-order

Indexable milling tools

Solid carbide end mills

XM series Interchangeable modular endmills

Applicable workpiece material table ○ Very suitable ○ Suitable

Workpiece material											
Carbon steel	Alloy steel	Pre-hardened steel, Hardened steel				Stainless steel	Cast iron, Nodular cast iron	Copper alloy	Aluminum alloy	Titanium alloy	Heat resistant alloy
		~40HRC	~50HRC	~55HRC	~68HRC						
○	○	○	○	○		○	○			○	○

The corresponding toolholder
B586-B589

Code key
B572

Graphics category and identification
B259

Cutting parameters
B591

XM series of interchangeable ball nose endmill



XM-2B

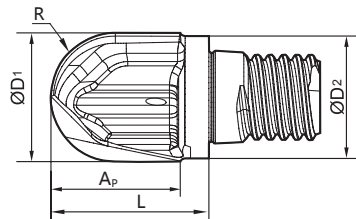

D	D ₁ ≤ 12	0-0.020
	D ₁ > 12	0-0.030



Type	Basic dimension(mm)					Interface	Number of teeth Z	Stock
	ØD ₁	ØD ₂	L	A _p	R			
Q07-XM-2B-D10.0	10	9.5	12.5	10.2	5.0	Q07	2	●
Q08-XM-2B-D12.0	12	11.5	15.3	11.45	6.0	Q08	2	●
Q10-XM-2B-D16.0	16	15.2	18	14	8.0	Q10	2	●

● Stock available ○ Make-to-order

Indexable milling tools

Solid carbide end mills

XM series Interchangeable modular endmills

Applicable workpiece material table ●Very suitable ○Suitable

Workpiece material											
Carbon steel	Alloy steel	Pre-hardened steel, Hardened steel				Stainless steel	Cast iron, Nodular cast iron	Copper alloy	Aluminum alloy	Titanium alloy	Heat resistant alloy
		~40HRC	~50HRC	~55HRC	~68HRC						
			○	●	●		○				

The corresponding toolholder B586-B589

Code key B572

Graphics category and identification B259

Cutting parameters B591

XM series Interchangeable modular endmills

XM series of interchangeable chamfered endmill

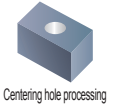

XM-2C

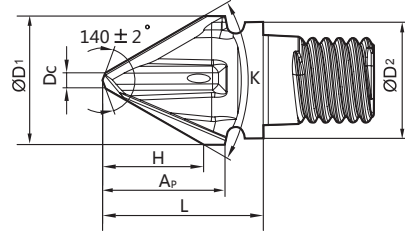

Coated
**NANO
TiAlN**

D	D ₁ ≤ 12	0-0.020
	D ₁ > 12	0-0.030



Type	Basic dimension(mm)							Interface	Number of teeth Z	Stock
	ØD ₁	ØD ₂	D _c	L	A _p	H	K			
Q07-XM-2C60-D10H7.7	10	9.5	1.5	12	9.3	7.7	60°	Q07	2	●
Q07-XM-2C90-D10H4.6	10	9.5	1.5	12	9.3	4.6	90°	Q07	2	●
Q07-XM-2C120-D10H2.8	10	9.5	1.5	12	9.3	2.8	120°	Q07	2	●
Q08-XM-2C60-D12H9.4	12	11.5	1.5	16	11	9.4	60°	Q08	2	●
Q08-XM-2C90-D12H5.6	12	11.5	1.5	16	11	5.6	90°	Q08	2	●
Q08-XM-2C120-D12H3.5	12	11.5	1.5	16	11	3.5	120°	Q08	2	●
Q10-XM-2C60-D16H12.2	16	15.2	2.5	18	14	12.2	60°	Q10	2	●
Q10-XM-2C90-D16H7.6	16	15.2	1.5	18	14	7.6	90°	Q10	2	●
Q10-XM-2C120-D16H4.5	16	15.2	1.5	18	14	4.5	120°	Q10	2	●

● Stock available ○ Make-to-order

Indexable milling tools

Solid carbide end mills

XM series Interchangeable modular endmills

Applicable workpiece material table ● Very suitable ○ Suitable

Workpiece material											
Carbon steel	Alloy steel	Pre-hardened steel, Hardened steel				Stainless steel	Cast iron, Nodular cast iron	Copper alloy	Aluminum alloy	Titanium alloy	Heat resistant alloy
		~40HRC	~50HRC	~55HRC	~68HRC						
●	●	●	●	●	○	●			○	○	

The corresponding toolholder
B586-B589

Code key
B572

Graphics category and identification
B259

Cutting parameters
B591



Fillet machining

XM series of interchangeable fillet endmill

XM-2CR

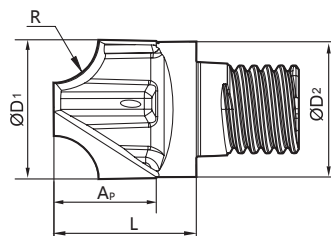

Coated
NANO TiAlN

D	D ₁ ≤ 12	0-0.020
	D ₁ > 12	0-0.030



Type	Basic dimension(mm)					Interface	Number of teeth Z	Stock
	ØD ₁	ØD ₂	R	L	A _p			
Q07-XM-2CR-D10.0R1.0	10	9.5	1	14	9.5	Q07	2	●
Q07-XM-2CR-D10.0R2.0	10	9.5	2	14	9.5	Q07	2	●
Q08-XM-2CR-D12.0R1.0	12	11.5	1	16	11.5	Q07	2	●
Q08-XM-2CR-D12.0R3.0	12	11.5	3	16	11.5	Q07	2	●
Q08-XM-2CR-D12.0R4.0	12	11.5	4	16	11.5	Q08	2	●
Q10-XM-2CR-D16.0R1.0	16	15.2	1	18	13.0	Q08	2	●
Q10-XM-2CR-D16.0R3.0	16	15.2	3	18	13.0	Q08	2	●
Q10-XM-2CR-D16.0R4.0	16	15.2	4	18	13.0	Q10	2	●
Q10-XM-2CR-D16.0R5.0	16	15.2	5	18	13.0	Q10	2	●

● Stock available ○ Make-to-order

Indexable
milling tools

Solid carbide
end mills

XM series Interchangeable modular endmills

Applicable workpiece material table ●Very suitable ○Suitable

Workpiece material											
Carbon steel	Alloy steel	Pre-hardened steel, Hardened steel				Stainless steel	Cast iron, Nodular cast iron	Copper alloy	Aluminum alloy	Titanium alloy	Heat resistant alloy
		~40HRC	~50HRC	~55HRC	~68HRC						
			○	●	●		○				

The corresponding toolholder B586-B589

Code key B572

Graphics category and identification B259

Cutting parameters B591

XM series Interchangeable modular endmills

XM series of interchangeable high feed endmill



XM-2H

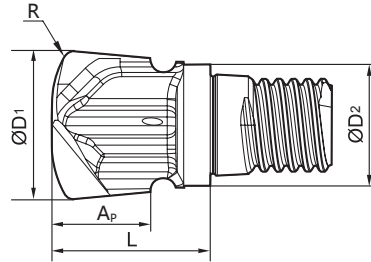

D	D ₁ ≤ 12	0-0.020
	D ₁ > 12	0-0.030



Type	Basic dimension(mm)					Interface	Number of teeth Z	Stock
	ØD ₁	ØD ₂	L	A _p	R			
Q07-XM-2H-D10.0R1.5	10	9.5	11	6	1.5	Q07	2	●
Q08-XM-2H-D12.0R2.0	12	11.5	11	6	2.0	Q08	2	●
Q10-XM-2H-D16.0R2.5	16	15.2	13.5	7	2.5	Q10	2	●

● Stock available ○ Make-to-order

Indexable milling tools

Solid carbide end mills

XM series Interchangeable modular endmills

Applicable workpiece material table ○ Very suitable ○ Suitable

Workpiece material											
Carbon steel	Alloy steel	Pre-hardened steel, Hardened steel				Stainless steel	Cast iron, Nodular cast iron	Copper alloy	Aluminum alloy	Titanium alloy	Heat resistant alloy
		~40HRC	~50HRC	~55HRC	~68HRC						
○	○	○	○	○		○	○			○	○

The corresponding toolholder → B586-B589

Code key → B572

Graphics category and identification → B259

Cutting parameters → B591

Selections of interchangeable straight shank

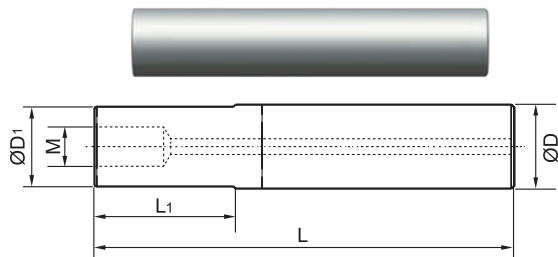

Picture 1

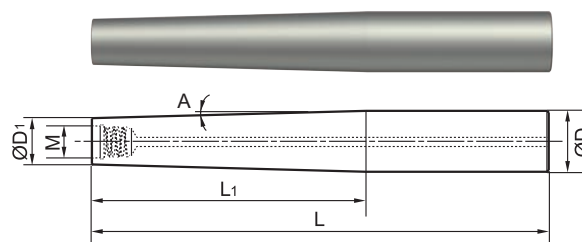

Picture 2

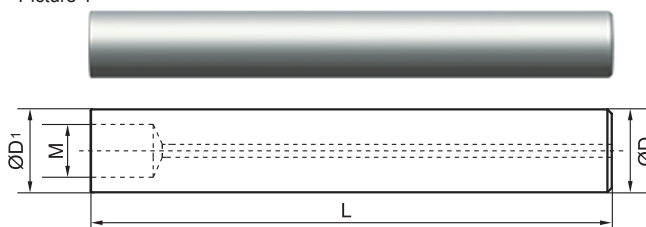

Picture 3

h ₆	12 ≤ D ₄ ≤ 16	20 ≤ D ₄ ≤ 25	25 ≤ D ₄ ≤ 32
	0-0.011	0-0.013	0-0.016

Inter face M	Type	Stock	Weight	Basic dimensions(mm)					Material	Picture	
				L	L ₁	ØD	ØD ₁	Angle A			
Q07	G10-QCH-Q07-65S	△	0.04	65	14					steel	Picture 1
	G10-QCH-Q07-75S	△	0.05	75	24						
	G10-QCH-Q07-85S	△	0.06	85	34						
	G10-QCH-Q07-55C	△	0.08	55	5	9.5					
	G10-QCH-Q07-75C	△	0.1	75	25	10					
	G10-QCH-Q07-85C	△	0.11	85	35				alloy	Picture 3	
	G10-QCH-Q07-105C	△	0.13	105	55						
	G10-QCH-Q07-125C	△	0.15	125	-	10					
	G10-QCH-Q07-145C	△	0.17	145							
	G12-QCH-Q07-120C-ZJ70	△	0.18	120	70	12	9.5	1°			Pic2
Q08	G12-QCH-Q08-65S	△	0.05	65	20				steel	Picture 1	
	G12-QCH-Q08-80S	△	0.06	80	35						
	G12-QCH-Q08-90S	△	0.07	90	45						
	G12-QCH-Q08-55C	△	0.08	55	5	12	11.5		alloy	Picture 3	
	G12-QCH-Q08-80C	△	0.11	80	30						
	G12-QCH-Q08-100C	△	0.14	100	50						
	G16-QCH-Q08-60S	△	0.08	60	7						
Q08	G12-QCH-Q08-120C	△	0.17	120	70		11.5		alloy	Picture 3	
	G12-QCH-Q08-155C	△	0.21	155	-	12					
	G12-QCH-Q08-165C	△	0.23	165							
	G16-QCH-Q08-60S	△	0.08	60	7	16	11.5		steel	Pic1	
	G16-QCH-Q08-140C-ZJ90	△	0.25	140	90			1°			alloy
	Q10	G16-QCH-Q10-80S	△	0.11	80	26.5				steel	
		G16-QCH-Q10-100S	△	0.14	100	42.5					
		G16-QCH-Q10-110S	△	0.15	110	58.5					
		G16-QCH-Q10-55C	△	0.13	55	5		15.2		alloy	Picture 3
		G16-QCH-Q10-90C	△	0.22	90	40	16				
G16-QCH-Q10-120C		△	0.3	120	70						
G16-QCH-Q10-150C		△	0.37	150	100						
G16-QCH-Q10-190C		△	0.47	190	-				steel	Pic1	
G16-QCH-Q10-205C		△	0.52	205							
G20-QCH-Q10-65S		△	0.14	65	10.5	20	15.2				alloy
G20-QCH-Q10-200C-ZJ140	△	0.69	200	140			0.8°				

Indexable milling tools

Solid carbide end mills

Interchangeable straight shank modular end mills

Interchangeable straight shank modular end mills

Inter face M	Type	Stock	Weight	Basic dimensions(mm)					Material	Picture	
				L	L ₁	ØD	ØD ₁	Angle A			
Q12	G20-QCH-Q12-90S	△	0.19	90	34.5					steel	Picture 1
	G20-QCH-Q12-110S	△	0.23	110	54.5						
	G20-QCH-Q12-125S	△	0.26	125	74.5						
	G20-QCH-Q12-65C	△	0.24	65	5		19				
	G20-QCH-Q12-100C	△	0.38	100	40	20					
	G20-QCH-Q12-140C	△	0.53	140	80					alloy	Picture 3
	G20-QCH-Q12-180C	△	0.68	180	120						
	G20-QCH-Q12-235C	△	0.9	235	-		20				
	G20-QCH-Q12-255C	△	0.98	255							
	G25-QCH-Q12-75S	△	0.24	75	14.5	25	19				
G25-QCH-Q12-250C-ZJ180	△	1.323	250	180			0.8°		alloy	Pic2	
Q14	G25-QCH-Q14-100S	△	0.34	100	43.5					steel	Picture 1
	G25-QCH-Q14-125S	△	0.42	125	68.5						
	G25-QCH-Q14-150S	△	0.5	150	93.5		25	24			
	G25-QCH-Q14-75C	△	0.27	75	5					alloy	Picture 1
	G25-QCH-Q14-120C	△	0.74	120	50						
	G25-QCH-Q14-170C	△	1.04	170	100						

Inter face M	Type	Stock	Weight	Basic dimensions(mm)					Material	Picture	
				L	L ₁	ØD	ØD ₁	Angle A			
Q14	G25-QCH-Q14-220C	△	1.35	220	150			24		alloy	Picture 3
	G25-QCH-Q14-290C	△	1.77	290	-	25		25			
	G25-QCH-Q14-310C	△	1.89	310						steel	Pic1
	G32-QCH-Q14-80S	△	0.42	80	18.5		32	24			
	G32-QCH-Q14-270C-ZJ200	△	2.38	270	200				0.8°	alloy	Pic2
	Q18	G32-QCH-Q18-125S	△	0.69	125	60					steel
G32-QCH-Q18-160S		△	0.88	160	92						
G32-QCH-Q18-185S		△	1.01	185	124						
G32-QCH-Q18-75C		△	0.82	75	5						
G32-QCH-Q18-140C		△	1.39	140	70		30				
G32-QCH-Q18-200C		△	1.96	200	130						
G32-QCH-Q18-260C		△	2.55	260	190					alloy	Picture 3
G32-QCH-Q18-320C		△	3.13	320	250						
G32-QCH-Q18-355C		△	3.42	355	-		32				
G32-QCH-Q18-385C		△	3.71	385							
G40-QCH-Q18-100S		△	0.81	100	28	40	30				

Indexable milling tools

Solid carbide end mills

Interchangeable straight shank modular end mills

Selections of interchangeable taper shank

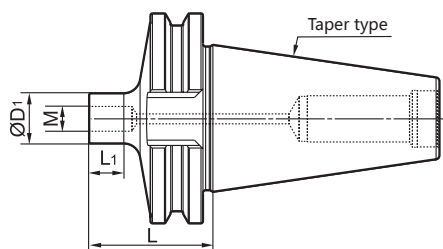

Picture 1

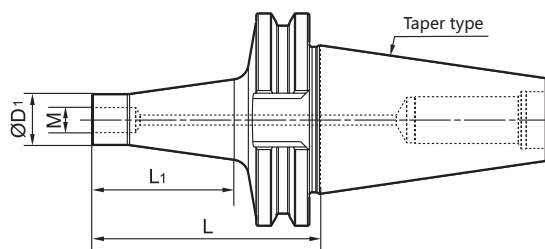

Picture 2

Inter face	Taper type	Specification	L	L ₁	Picture	Weight (Kg)
Q07	BT30	BT30-QCH-Q07-33S	33.63	5	Picture 1	0.32
	BT40	BT40-QCH-Q07-40S	40.13	5	Picture 1	0.92
	BT50	BT50-QCH-Q07-54S	54.3	5	Picture 1	3.76
	BT30	BT30-QCH-Q07-41S	41.66	14	Picture 2	0.31
	BT40	BT40-QCH-Q07-57S	57.86	24	Picture 2	0.94
	BT50	BT50-QCH-Q07-81S	81.73	34	Picture 2	3.81
Q08	BT30	BT30-QCH-Q08-35S	35.63	7	Picture 1	0.4
	BT40	BT40-QCH-Q08-42S	42.13	7	Picture 1	1.01
	BT50	BT50-QCH-Q08-56S	56.3	7	Picture 1	3.8
	BT30	BT30-QCH-Q08-46S	46.66	19	Picture 2	0.41
	BT40	BT40-QCH-Q08-64S	64.86	31	Picture 2	1.05
	BT50	BT50-QCH-Q08-90S	90.73	43	Picture 2	3.86
Q10	BT30	BT30-QCH-Q10-38S	38.8	10.5	Picture 1	0.41
	BT40	BT40-QCH-Q10-45S	45.3	10.5	Picture 1	1.02
	BT50	BT50-QCH-Q10-59S	59.48	10.5	Picture 1	3.8
	BT30	BT30-QCH-Q10-53S	53.73	26.5	Picture 2	0.44
	BT40	BT40-QCH-Q10-75S	75.83	42.5	Picture 2	1.1
	BT50	BT50-QCH-Q10-105S	105.61	58.5	Picture 2	3.96
Q12	BT30	BT30-QCH-Q12-42S	42.47	14.5	Picture 1	0.42
	BT40	BT40-QCH-Q12-48S	48.97	14.5	Picture 1	1.03
	BT50	BT50-QCH-Q12-63S	63.14	14.5	Picture 1	3.81
	BT30	BT30-QCH-Q12-61S	61.3	34.5	Picture 2	0.48
	BT40	BT40-QCH-Q12-87S	87.3	54.5	Picture 2	1.18
	BT50	BT50-QCH-Q12-120S	120.98	74.5	Picture 2	4.1
Q14	BT30	BT30-QCH-Q14-46S	46.03	18.5	Picture 1	0.45
	BT40	BT40-QCH-Q14-52S	52.53	18.5	Picture 1	1.06
	BT50	BT50-QCH-Q14-66S	66.7	18.5	Picture 1	3.84
	BT30	BT30-QCH-Q14-69S	69.8	43.5	Picture 2	0.57
	BT40	BT40-QCH-Q14-100S	100.61	68.5	Picture 2	1.37
	BT50	BT50-QCH-Q14-139S	139.16	93.5	Picture 2	4.41
Q18	BT40	BT40-QCH-Q18-61S	61.5	28	Picture 1	1.14
	BT50	BT50-QCH-Q18-75S	75.67	28	Picture 1	3.92
	BT40	BT40-QCH-Q18-122S	122.44	92	Picture 2	1.74
	BT50	BT50-QCH-Q18-168S	168.62	124	Picture 2	5.07

Inter face	Taper type	Specification	L	L ₁	Picture	Weight (Kg)
Q07	JT30	JT30-QCH-Q07-31S	31.26	5	Picture 1	0.32
	JT40	JT40-QCH-Q07-32S	32.49	5	Picture 1	0.83
	JT50	JT50-QCH-Q07-35S	35.32	5	Picture 1	3.38
	JT30	JT30-QCH-Q07-39S	39.28	14	Picture 2	0.31
	JT40	JT40-QCH-Q07-50S	50.22	24	Picture 2	0.85
	JT50	JT50-QCH-Q07-62S	62.74	34	Picture 2	3.43
Q08	JT30	JT30-QCH-Q08-33S	33.26	7	Picture 1	0.4
	JT40	JT40-QCH-Q08-34S	34.49	7	Picture 1	0.87
	JT50	JT50-QCH-Q08-37S	37.32	7	Picture 1	2.79
	JT30	JT30-QCH-Q08-44S	44.28	19	Picture 2	0.41
	JT40	JT40-QCH-Q08-57S	57.22	31	Picture 2	0.9
	JT50	JT50-QCH-Q08-71S	71.74	43	Picture 2	2.85
Q10	JT30	JT30-QCH-Q10-36S	36.43	10.5	Picture 1	0.41
	JT40	JT40-QCH-Q10-37S	37.67	10.5	Picture 1	0.88
	JT50	JT50-QCH-Q10-40S	40.49	10.5	Picture 1	2.79
	JT30	JT30-QCH-Q10-51S	51.36	26.5	Picture 2	0.43
	JT40	JT40-QCH-Q10-68S	68.2	42.5	Picture 2	0.96
	JT50	JT50-QCH-Q10-86S	86.62	58.5	Picture 2	2.95
Q12	JT30	JT30-QCH-Q12-40S	40.1	14.5	Picture 1	0.42
	JT40	JT40-QCH-Q12-41S	41.33	14.5	Picture 1	0.89
	JT50	JT50-QCH-Q12-44S	44.15	14.5	Picture 1	2.8
	JT30	JT30-QCH-Q12-58S	58.92	34.5	Picture 2	0.48
	JT40	JT40-QCH-Q12-79S	79.66	54.5	Picture 2	1.04
	JT50	JT50-QCH-Q12-101S	101.99	74.5	Picture 2	3.09
Q14	JT30	JT30-QCH-Q14-43S	43.66	18.5	Picture 1	0.45
	JT40	JT40-QCH-Q14-44S	44.89	18.5	Picture 1	0.92
	JT50	JT50-QCH-Q14-47S	47.71	18.5	Picture 1	2.84
	JT30	JT30-QCH-Q14-67S	67.36	43.5	Picture 2	0.57
	JT40	JT40-QCH-Q14-92S	92.97	68.5	Picture 2	1.22
	JT50	JT50-QCH-Q14-120S	120.18	93.5	Picture 2	3.4
Q18	JT40	JT40-QCH-Q18-53S	53.86	28	Picture 1	1.0
	JT50	JT50-QCH-Q18-56S	56.68	28	Picture 1	2.91
	JT40	JT40-QCH-Q18-115S	115.6	92	Picture 2	1.61
	JT50	JT50-QCH-Q18-149S	149.63	124	Picture 2	4.07

Indexable milling tools

Solid carbide end mills

PM series with interchangeable taper shank

Selections of interchangeable HSK shank

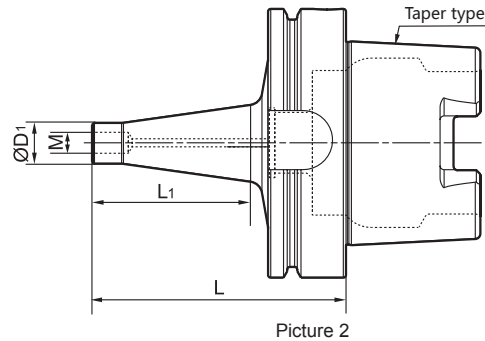
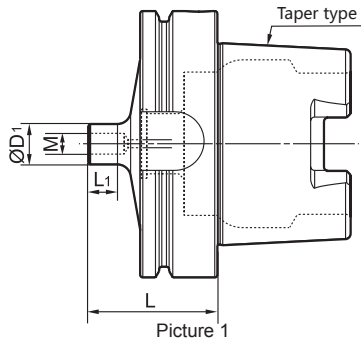

Interface	Shank type	Specification	Basic dimensions(mm)			Picture	Weight
			L	L ₁	D ₁		
Q07	HSK63	HSK63-QCH-Q07-40S	38	5.0	9.5	Picture 1	0.60
	HSK63	HSK63-QCH-Q07-64S	57	24.0		Picture 2	0.66
	HSK100	HSK100-QCH-Q07-43S	41	5.0		Picture 1	1.82
	HSK100	HSK100-QCH-Q07-82S	73	34.0		Picture 2	2.01
Q08	HSK63	HSK63-QCH-Q08-40S	40	7	11.5	Picture 1	0.66
	HSK63	HSK63-QCH-Q08-64S	64	31		Picture 2	0.71
	HSK100	HSK100-QCH-Q08-43S	43	7		Picture 1	2.0
	HSK100	HSK100-QCH-Q08-82S	82	43		Picture 2	2.16
Q10	HSK63	HSK63-QCH-Q10-43S	43	10.5	15.2	Picture 1	0.64
	HSK63	HSK63-QCH-Q10-74S	74	42.5		Picture 2	0.75
	HSK100	HSK100-QCH-Q10-48S	48	10.5		Picture 1	2.05
	HSK100	HSK100-QCH-Q10-94S	94	58.5		Picture 2	2.2
Q12	HSK63	HSK63-QCH-Q12-46S	46	14.5	19	Picture 1	0.69
	HSK63	HSK63-QCH-Q12-86S	86	54.5		Picture 2	0.84
	HSK100	HSK100-QCH-Q12-48S	48	14.5		Picture 1	2.02
	HSK100	HSK100-QCH-Q12-112S	112	74.5		Picture 2	2.42
Q14	HSK63	HSK63-QCH-Q14-51S	51	18.5	24	Picture 1	0.74
	HSK63	HSK63-QCH-Q14-100S	100	68.5		Picture 2	1.03
	HSK100	HSK100-QCH-Q14-55S	55	18.5		Picture 1	2.13
	HSK100	HSK100-QCH-Q14-130S	130	93.5		Picture 2	2.73
Q18	HSK63	HSK63-QCH-Q18-59S	59	28	30	Picture 1	0.79
	HSK63	HSK63-QCH-Q18-120S	120	92		Picture 2	1.38
	HSK100	HSK100-QCH-Q18-60S	60	28		Picture 1	2.15
	HSK100	HSK100-QCH-Q18-155S	155	124		Picture 2	3.28

Indexable milling tools

Solid carbide end mills

Interchangeable HSK shank end mills



MILLING / Solid Carbide End Mills

Recommended cutting parameters for interchangeable module endmills

PM-4E★PM-2B★PM-4B★PM-4R

Recommended cutting speed

Workpiece material	P	M	K	N	S	H
Cutting speed Vc						
Vc(m/min)	70 ~ 280	60 ~ 160	80 ~ 280	270 ~ 840	20 ~ 70	30 ~ 80

Cutting parameters : (mm)

Edge diameter	Machining methods	Slotting			Side 、 Face milling			Profiling		
		f _z (mm/z)	Cutting width a _e	Cutting depth a _p	f _z (mm/z)	Cutting width a _e	Cutting depth a _p	f _z (mm/z)	Cutting width a _e	Cutting depth a _p
10		0.03 ~ 0.09	1D	0.1 ~ 0.5D	0.03~ 0.05D	0.1 ~ 0.5D	0.02 ~ 0.1	0.1 ~ 0.3R	0.05 ~ 0.15R	
12	0.04 ~ 0.10	0.03 ~ 0.11								
16	0.05 ~ 0.12	0.05 ~ 0.13								
20	0.05 ~ 0.15	0.05 ~ 0.17								
25	0.06 ~ 0.15	0.06 ~ 0.18								
32	0.06 ~ 0.18	0.06 ~ 0.22								

Adjustments of the cutting parameters for different xD shanks

Cutting parameters	Cutting speed (%)	Feed rate (%)	Cutting width (%)
Overhang xD			
2	100	100	100
3	100	100	100
4	80	90	70
5	60	80	40
7	30	60	20
9	20	50	10

HMX-4E★HMX-2B★HMX-4B★HMX-4R

Recommended cutting speed

Workpiece material	H		
cutting speed Vc	40 - 50HRC	50 - 60HRC	60 - 68HRC
Vc(m/min)	260 ~ 320	150 ~ 220	100 ~ 200

Cutting parameters : (mm)

Edge diameter	Machining methods	Side 、 Face milling			Profiling		
		f _z (mm/z)	Cutting width a _e	Cutting depth a _p	f _z (mm/z)	Cutting width a _e	Cutting depth a _p
10		0.02 ~ 0.06	0.02 ~ 0.05D	0.1 ~ 0.5D	0.04 ~ 0.13	0.25R	0.1R
12	0.03 ~ 0.07	0.05 ~ 0.15			0.3R	0.1R	
16	0.03 ~ 0.07	0.08 ~ 0.18			0.35R	0.1R	
20	0.04 ~ 0.08	0.10 ~ 0.22			0.4R	0.1R	
25	0.04 ~ 0.08	0.12 ~ 0.25			0.5R	0.12R	
32	0.05 ~ 0.10	0.15 ~ 0.30			0.6R	0.12R	

Adjustments of the cutting parameters for different xD shanks

Cutting parameters	Cutting speed (%)	Feed rate (%)	Cutting width (%)
Overhang xD			
2	100	100	100
3	100	100	100
4	80	90	70
5	60	80	40
7	30	60	20
9	20	50	10

Indexable milling tools

Solid carbide end mills

Recommended cutting parameters for interchangeable module endmills

Recommended cutting parameters for interchangeable module endmills

XM-2B★XM-2H★XM-2C/2CR

▶▶ Recommended cutting speed

Workpiece material	P	M	K	N	S	H
Cutting speed Vc						
Vc(m/min)	70 ~ 280	60 ~ 160	80 ~ 280	270 ~ 840	20 ~ 70	30 ~ 80

▶▶ Cutting parameters : (mm)

Machining methods	XM-2B			XM-2H			XM-2C/2CR		
	f _z (mm/z)	Cutting width a _e	Cutting depth a _p	f _z (mm/z)	Cutting width a _e	Cutting depth a _p	f _z (mm/z)	Cutting width a _e	Cutting depth a _p
Edge diameter 10	0.03 ~ 0.11	0.3R	0.1R	0.4 ~ 0.8	0.65D	0.25R	0.07 ~ 0.12	0.1D	0.1D
12	0.04 ~ 0.12			0.5 ~ 0.9			0.08 ~ 0.12		
16	0.05 ~ 0.13			0.6 ~ 1.0			0.1 ~ 0.12		

1. Please adopt high precision machining center and shank holder.
2. Climb milling is recommended on side milling.
3. Please reduce the rev and feed rate if there are vibrations and abnormal noise under the circumstances of the bad rigidity of machine.
4. In the condition of interference-free, the extended length of milling cutter should be short as much as possible.

▶▶ Adjustments of the cutting parameters for different xD shanks

Cutting parameters	Cutting speed (%)	Feed rate (%)	Cutting width (%)
Overhang xD 2	100	100	100
3	100	100	100
4	80	90	70
5	60	80	40
7	30	60	20
9	20	50	10

XM-2E★XM-2R

▶▶ Recommended cutting speed

Workpiece material	P	M	K	N	S	H
Cutting speed Vc						
Vc(m/min)	70 ~ 280	60 ~ 160	80 ~ 280	270 ~ 840	20 ~ 70	30 ~ 80

▶▶ Cutting parameters : (mm)

Machining methods	Side、Face milling						Slotting					
	XM-2E			XM-2R			XM-2E			XM-2R		
	f _z (mm/z)	Cutting width a _e	Cutting depth a _p	f _z (mm/z)	Cutting width a _e	Cutting depth a _p	f _z (mm/z)	Cutting width a _e	Cutting depth a _p	f _z (mm/z)	Cutting width a _e	Cutting depth a _p
Edge diameter 10	0.035-0.09	0.1-0.15D	0.75D	0.035-0.09	0.2D	0.4D	0.02-0.045	1D	0.3D	0.02-0.045	1D	0.3D
12	0.04-0.1			0.04-0.1			0.02-0.05			0.02-0.05		
16	0.05-0.12			0.05-0.12			0.025-0.06			0.025-0.06		

1. The cutting speed should be 50%~70% of above recommendations when doing slot milling.
2. Please adopt high precision machining center and shank holder.
4. Climb milling is recommended on side milling.
4. Please reduce the rev and feed rate if there are vibrations and abnormal noise under the circumstances of the bad rigidity of machine.
5. In the condition of interference-free, the extended length of milling cutter should be short as much as possible.

▶▶ Adjustments of the cutting parameters for different xD shanks

Cutting parameters	Cutting speed (%)	Feed rate (%)	Cutting width (%)
Overhang xD 2	100	100	100
3	100	100	100
4	80	90	70
5	60	80	40
7	30	60	20
9	20	50	10

Indexable milling tools

Solid carbide end mills

Recommended cutting parameters for interchangeable module endmills

Technical information

▶▶ Tolerance of shank (mm)

Diameter (mm)	12/16	20	25	32
radial runout	0.015	0.015	0.02	0.02
total runout	0.01	0.01	0.01	0.01

▶▶ Wrench

	Interface type	Applicative series	Wrench specifications	Installation torque
	Q07	PM/HMX	QCH-7.5×8	10N.M
	Q08		QCH-10×13	16N.M
	Q10			20N.M
	Q12			30N.M
	Q14			40N.M
	Q18		QCH-26	50N.M
	Q07	XM	QCH-5×6.5	10N.M
	Q08		15N.M	
	Q10		20N.M	

The wrench need to be purchased separately

Cutting head installation instructions

- ▶ Use the clean cotton to remove the oil and dust on the interface cone, end face, and threads.
- ▶ While you are using your hands directly contact the cutting edges during clamping. It may cause injury, please use protective equipment.
- ▶ After installing the cutting head, if there is a gap between the cutting head and the end face of the shank, please use the wrench to tighten it until it fits completely.
- ▶ For strict operation requirements, please use the recommended torque to install the cutting head.

Remove the oil and dust

